

## **BASE 9 & 12**

---

Designed by Zuzana Licko in 1995.

The Base fonts consist of three families; two families based on 12 point screen fonts (one serif and one sans serif family) named Base-12, and one family based on 9 point screen fonts named Base-9, consisting of a total of 24 individual faces.

When Base was designed in 1994-95, the goal was to create a comprehensive family of screen fonts with companion printer fonts, somewhat similar in purpose to Matthew Carter's well known typeface Verdana. In the design process of these typefaces, the screen fonts largely dictated the look of the printer fonts, rather than the other way around, because outline fonts are more flexible and are easier to adapt. For example, the proportions of the screen font determined the exact character widths within which the outline characters were adjusted to fit. Usually this process is reversed—character widths are normally adjusted to fit around the outline characters. Therefore, certain compromises had to be made, giving Base 9 & 12 a unique character reminiscent of the early computer technology era.

For more information, see:

<https://www.emigre.com/Fonts/Base-9-and-12>

More Digital Font Sketches:

<https://www.emigre.com/DigitalFontSketches>

**BASE 9 & 12**

BaseNine Regular | hyphen | RoboFog Sketches | 1995 | Emigre Fonts

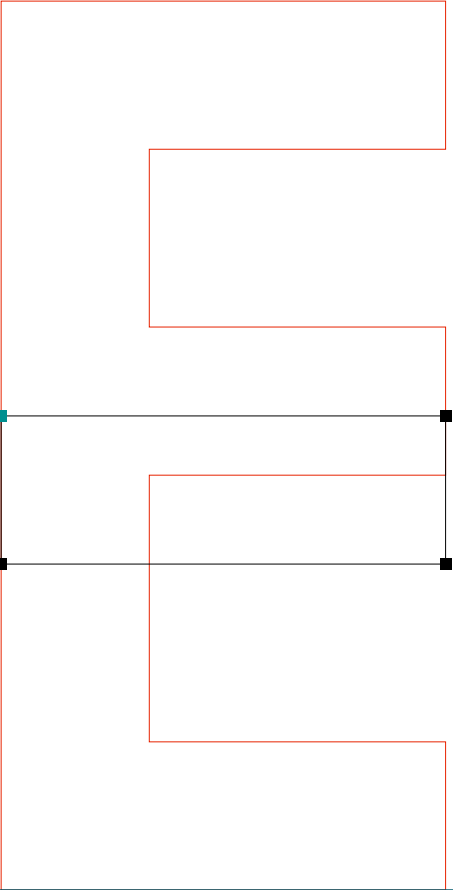

**BASE 9 & 12**

.....  
BaseNine Regular | six | RoboFog Sketches | 1995 | Emigre Fonts

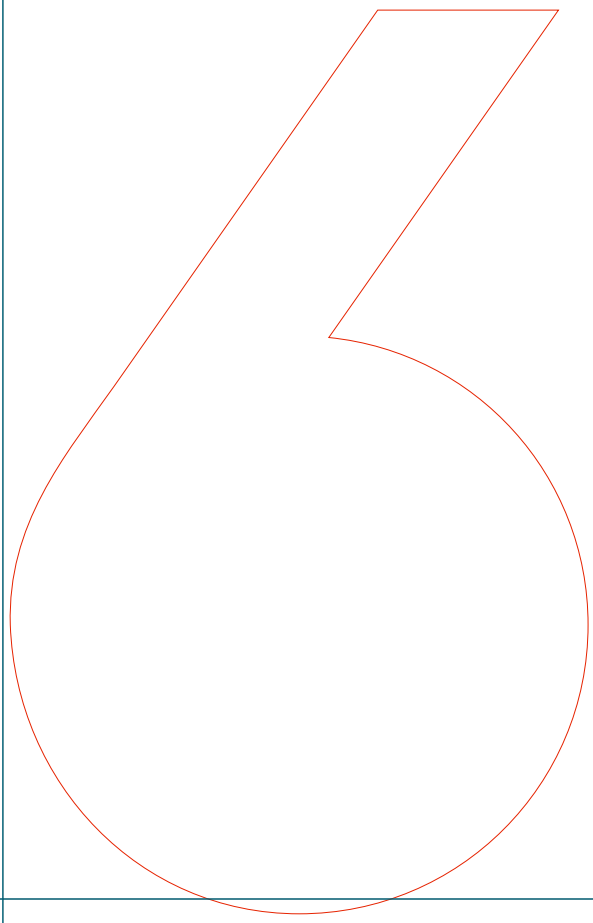
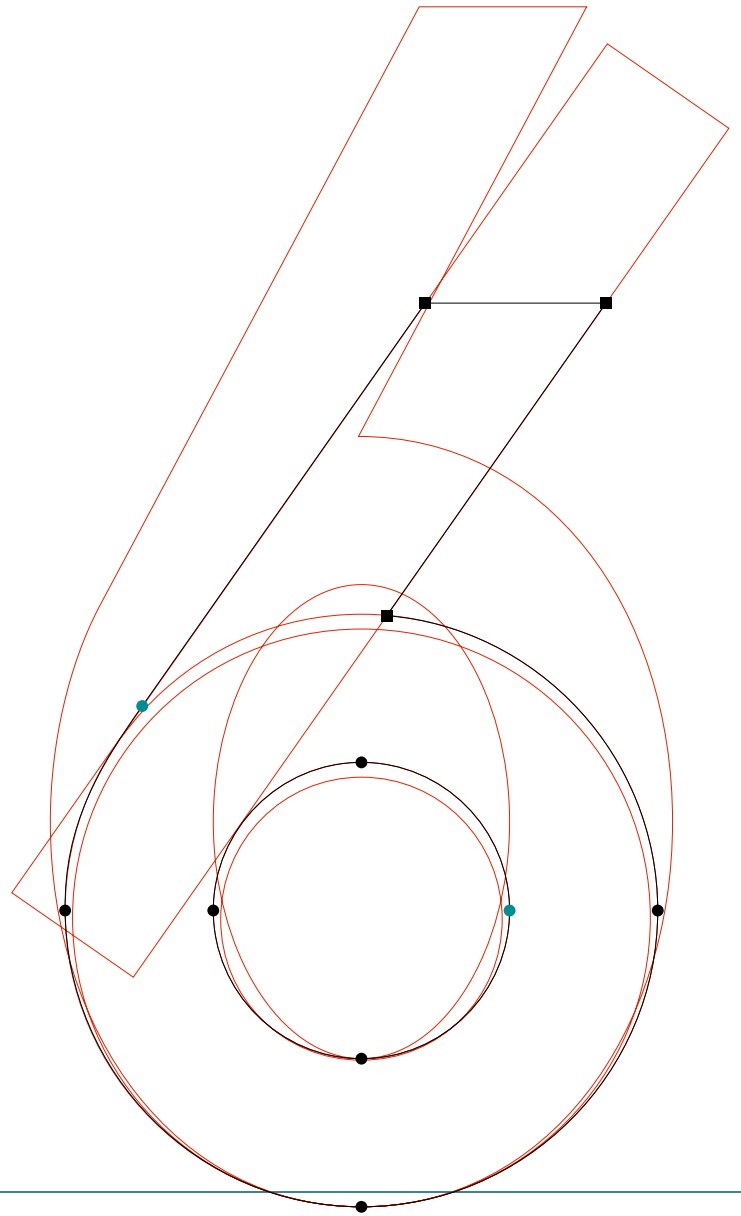

**BASE 9 & 12**

BaseNine Regular | question | RoboFog Sketches | 1995 | Emigre Fonts

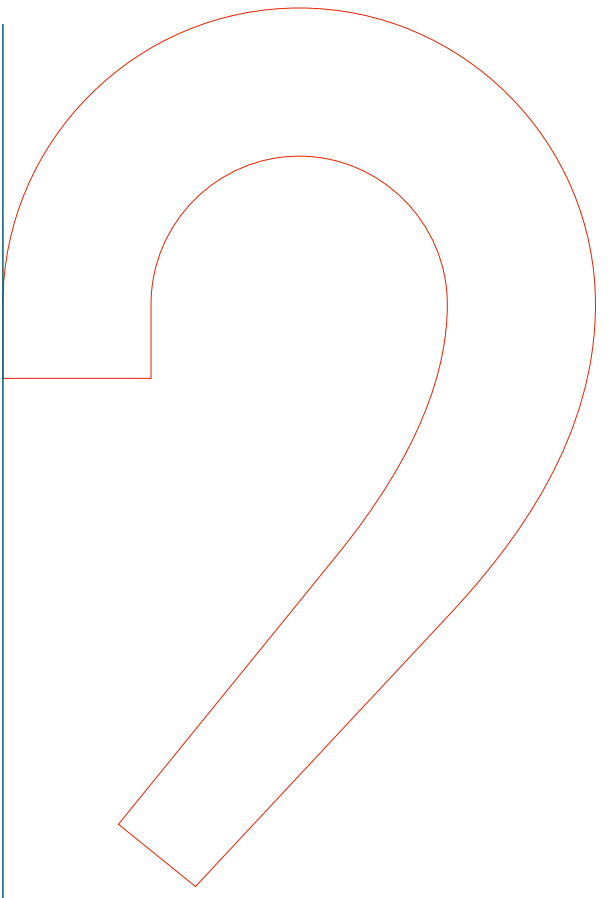
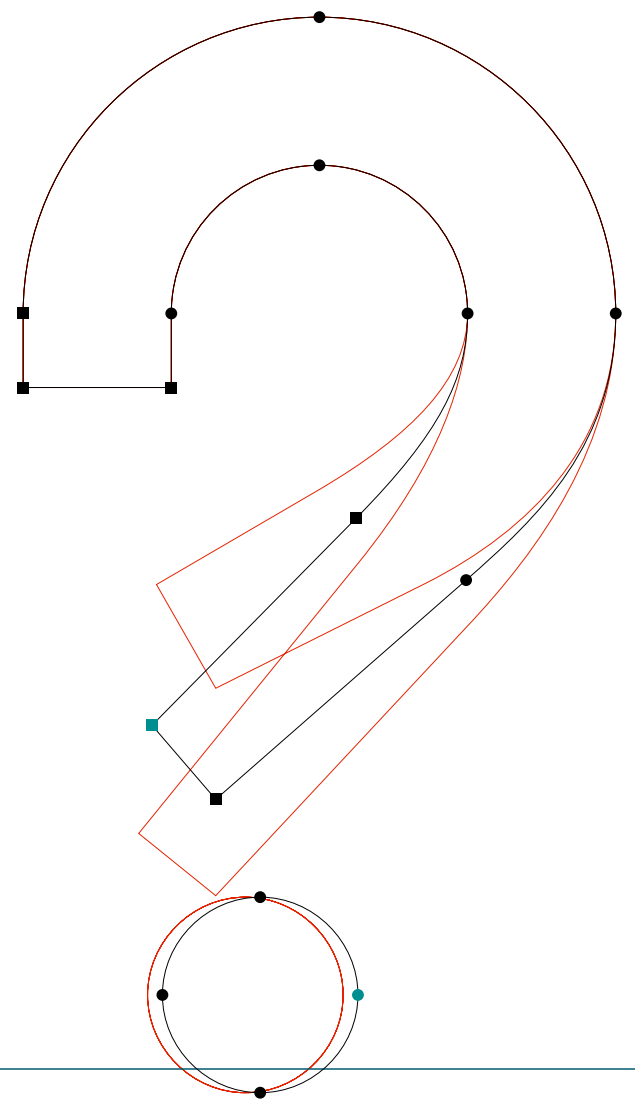

**BASE 9 & 12**

.....  
BaseNine Regular | W | RoboFog Sketches | 1995 | Emigre Fonts

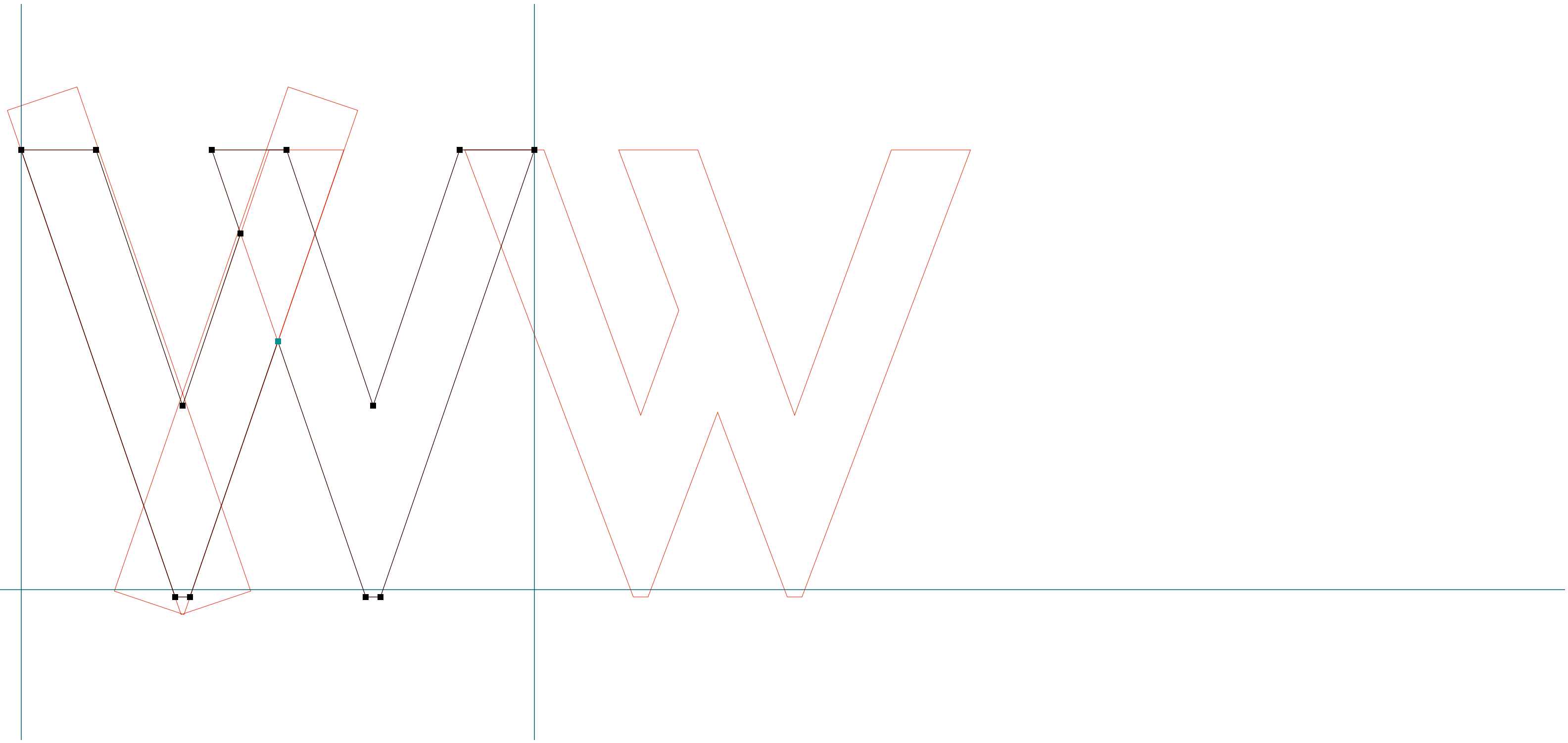

**BASE 9 & 12**

.....  
BaseNine Regular | X | RoboFog Sketches | 1995 | Emigre Fonts

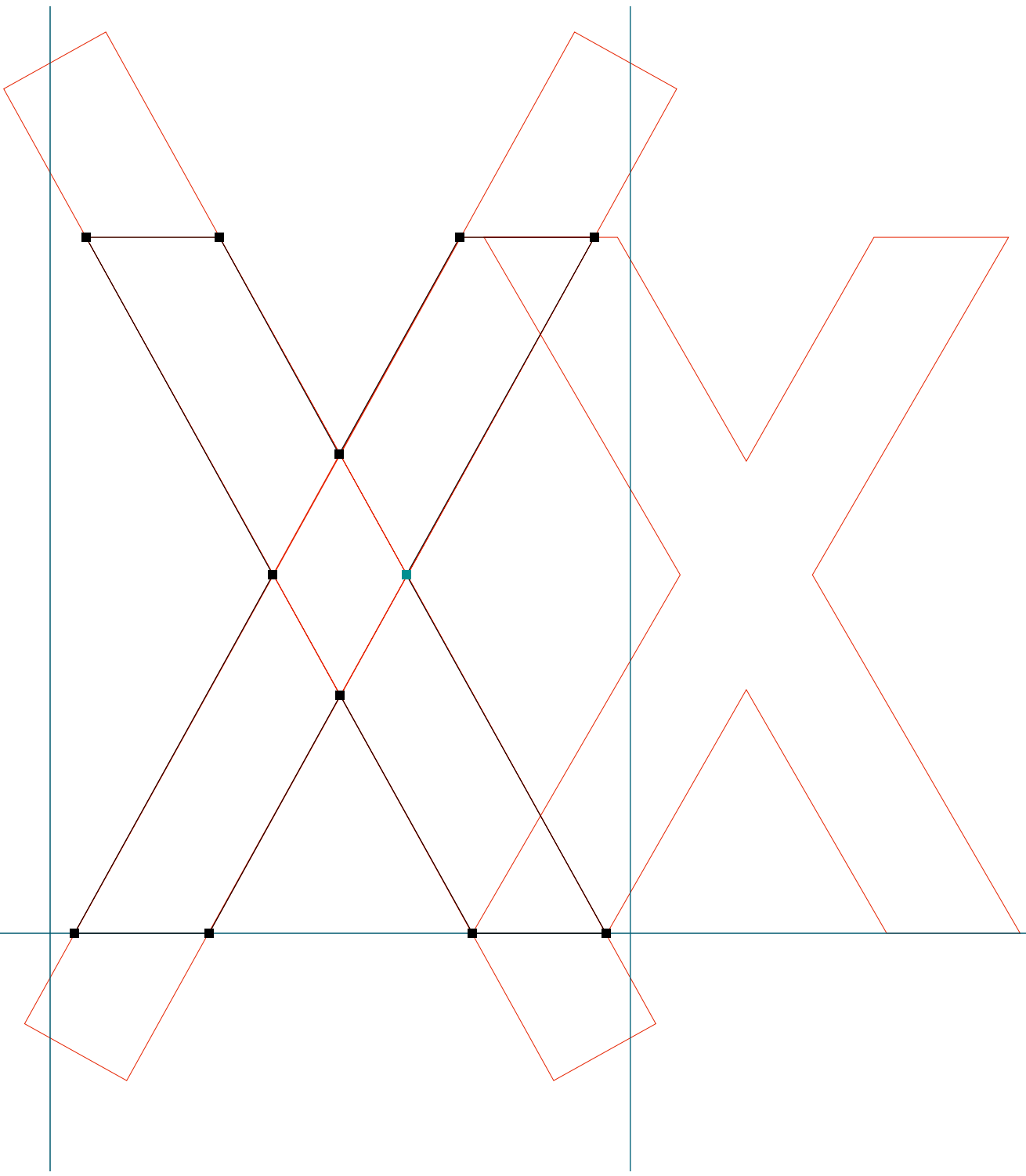

**BASE 9 & 12**

.....  
BaseNine Regular | a | RoboFog Sketches | 1995 | Emigre Fonts

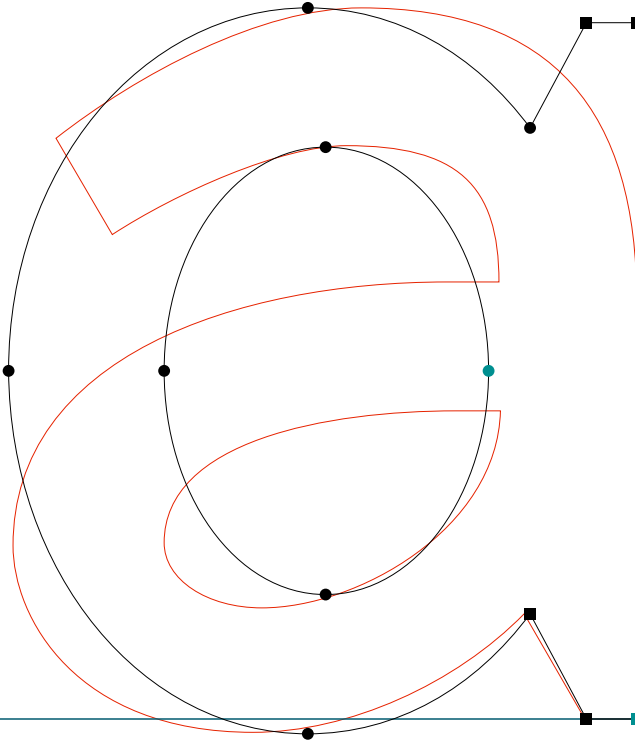

**BASE 9 & 12**

BaseNine Regular | d | RoboFog Sketches | 1995 | Emigre Fonts

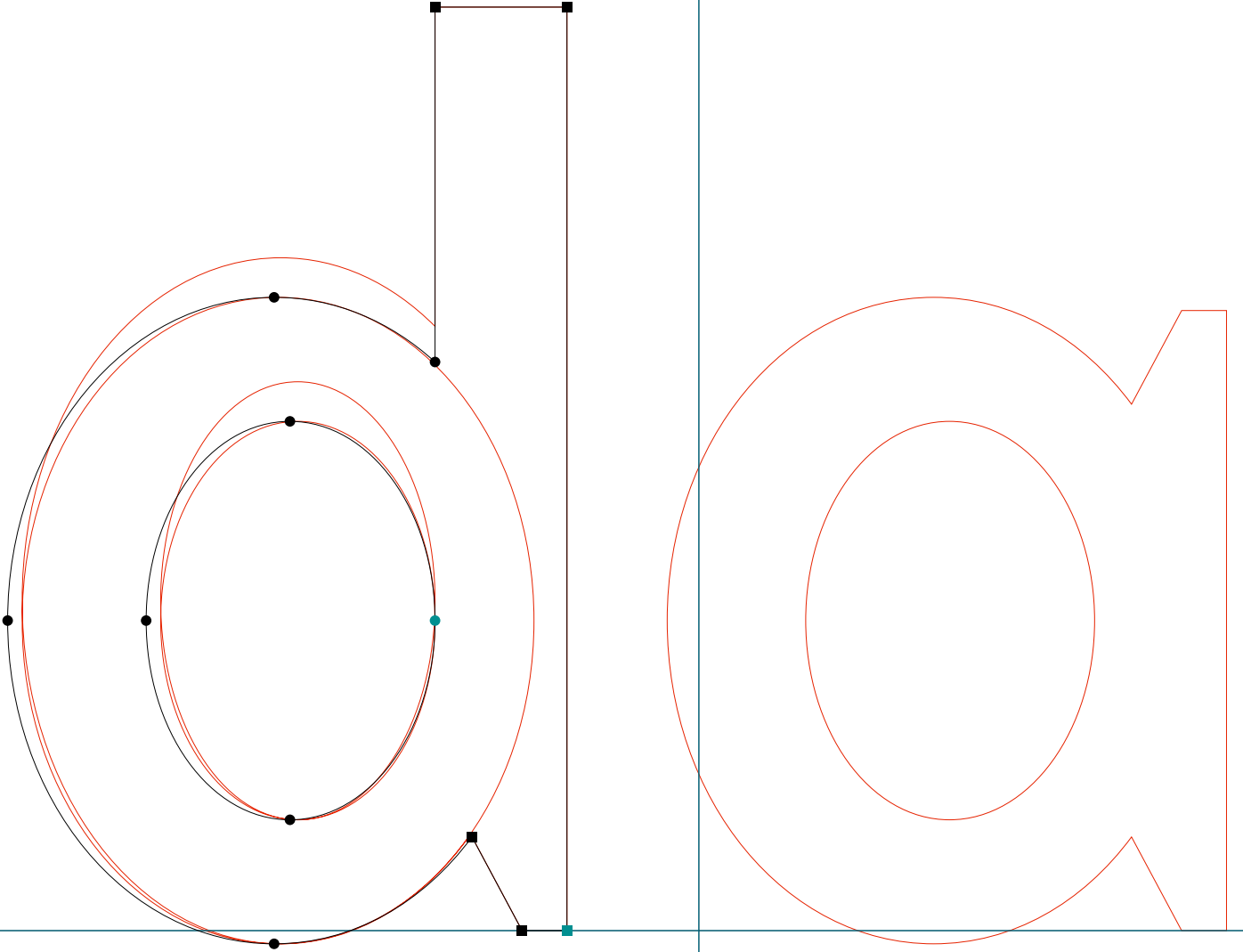



**BASE 9 & 12**

.....  
BaseNine Regular | e | RoboFog Sketches | 1995 | Emigre Fonts

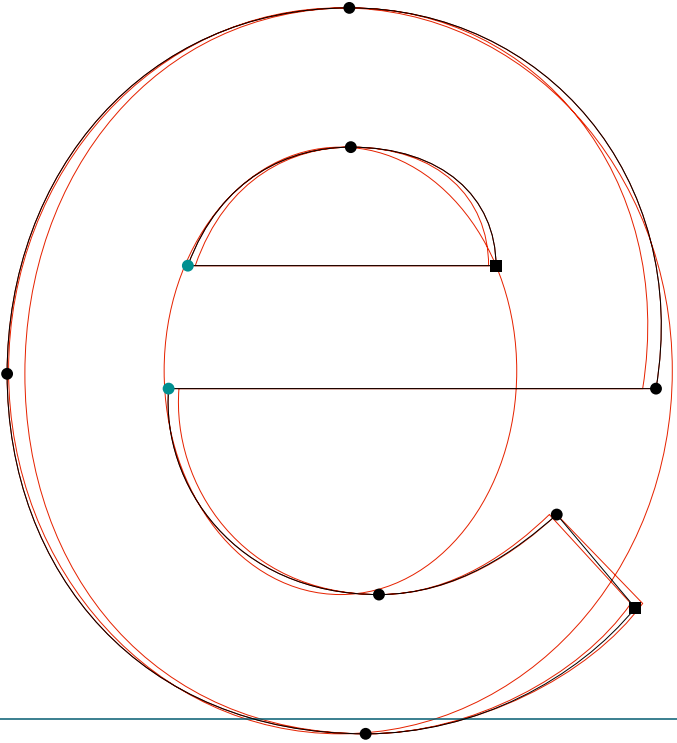

**BASE 9 & 12**

.....  
BaseNine Regular | w | RoboFog Sketches | 1995 | Emigre Fonts

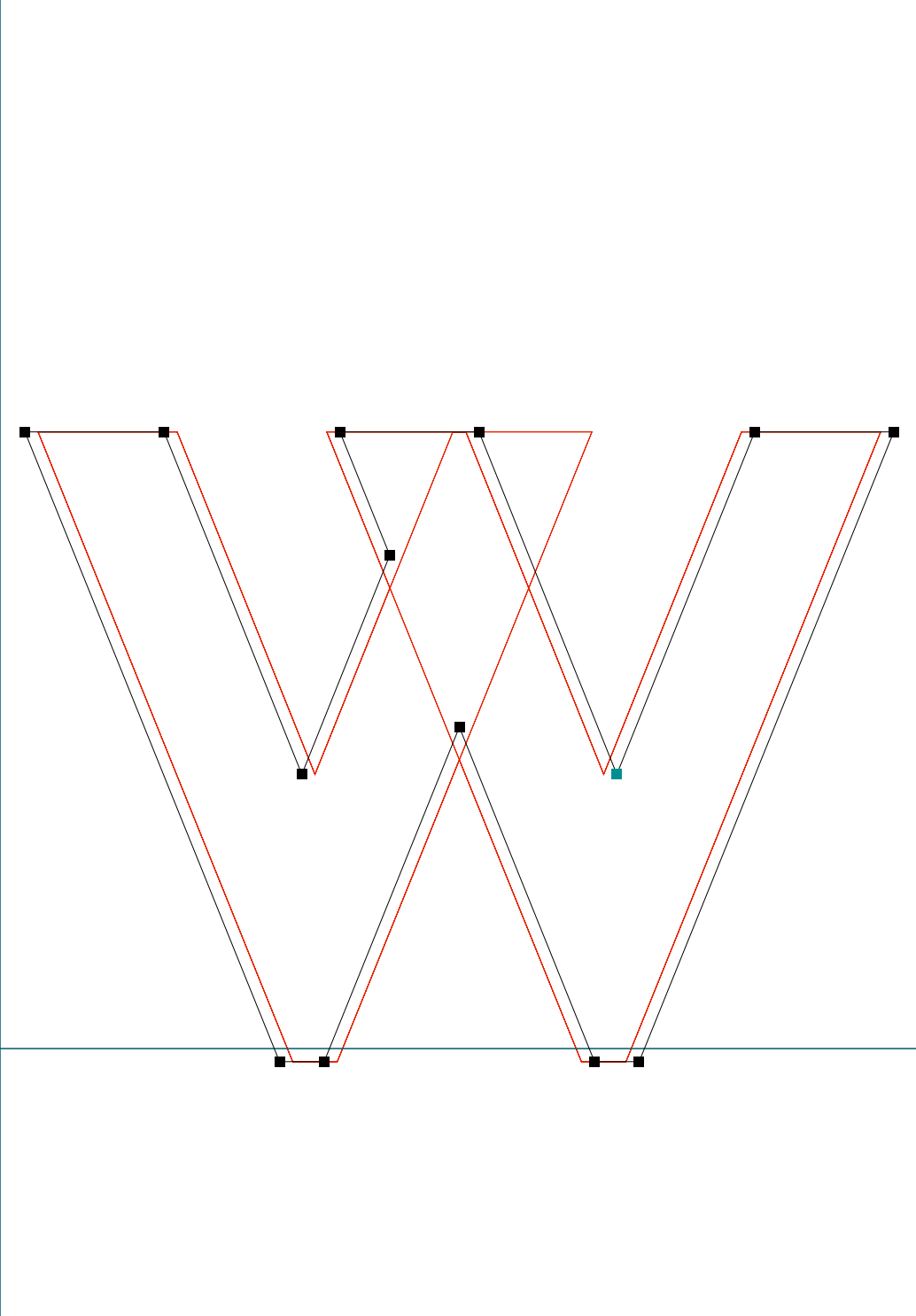

**BASE 9 & 12**

.....  
BaseNine Regular | exclamdown | RoboFog Sketches | 1995 | Emigre Fonts

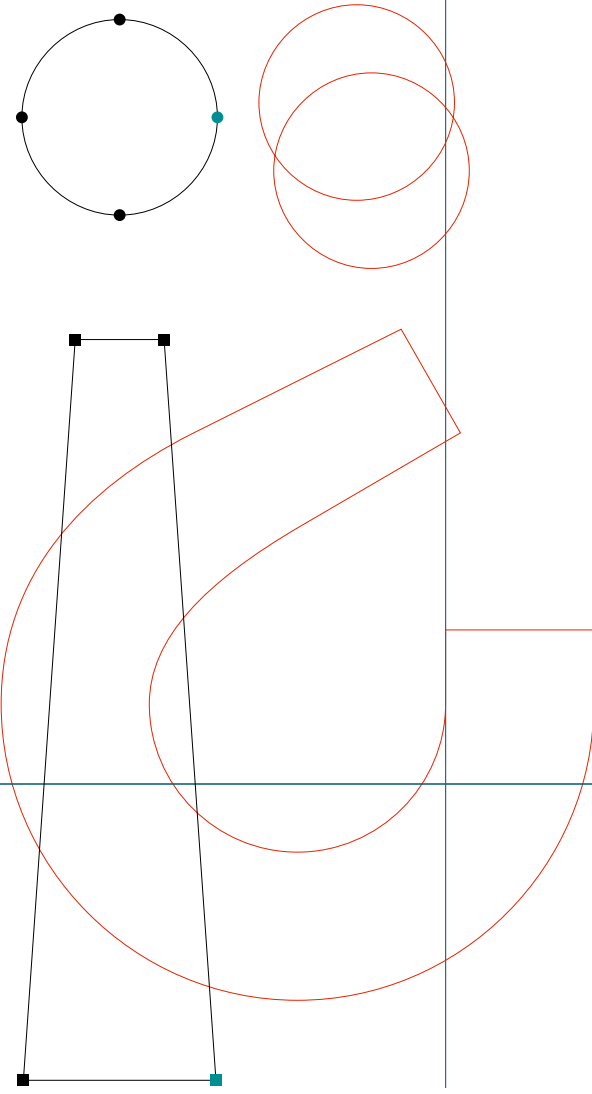

**BASE 9 & 12**

BaseNine SmallCaps | dollar | RoboFog Sketches | 1995 | Emigre Fonts

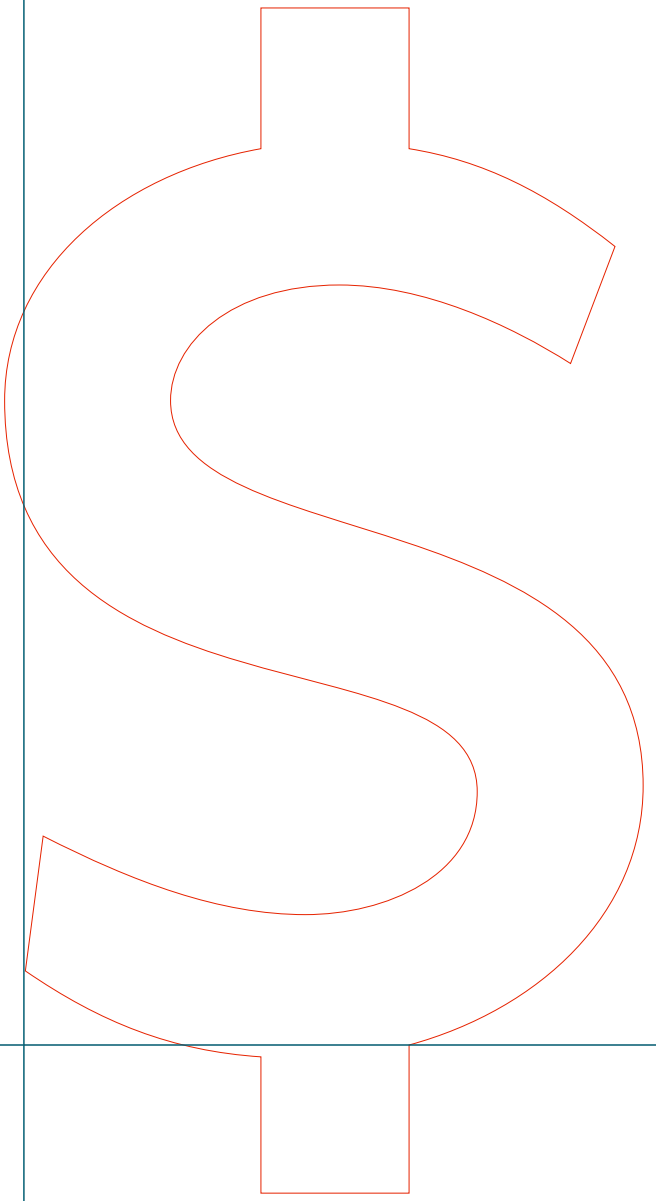
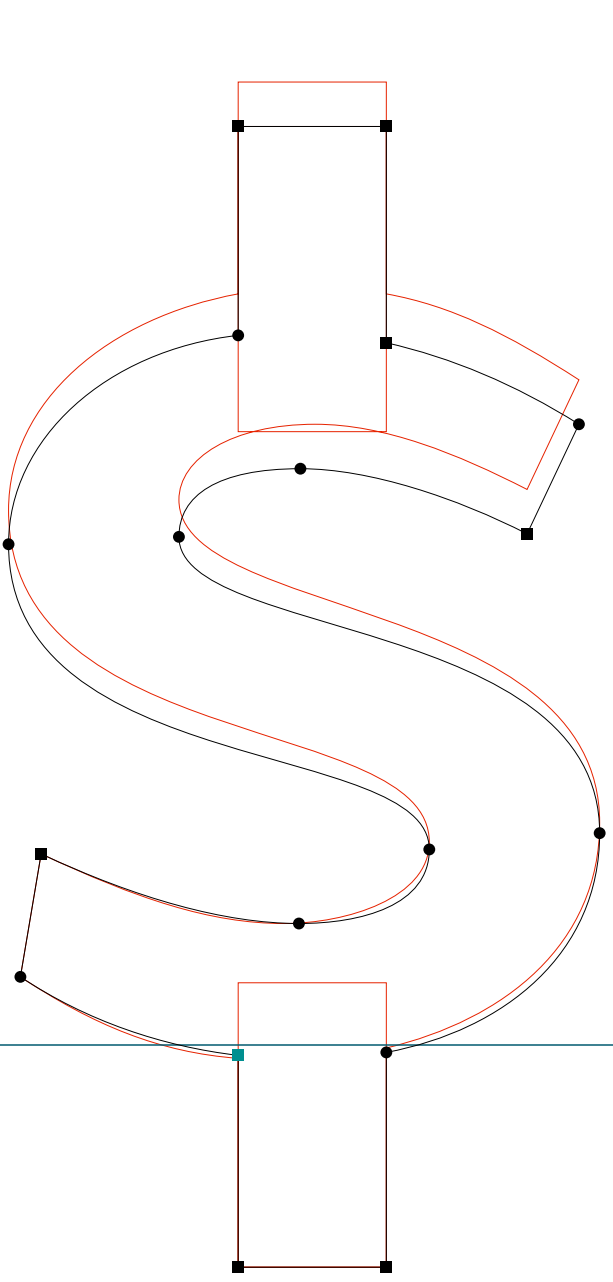



**BASE 9 & 12**

.....  
BaseNine SmallCaps | three | RoboFog Sketches | 1995 | Emigre Fonts

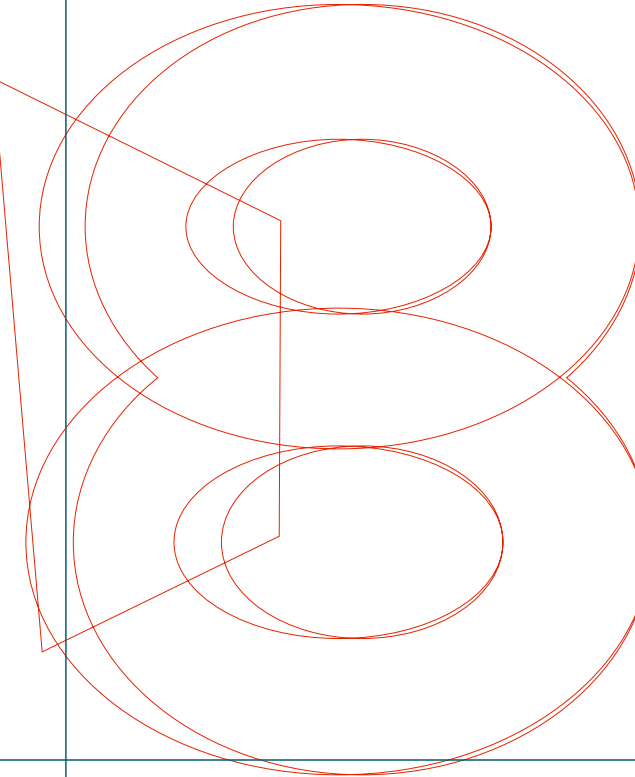
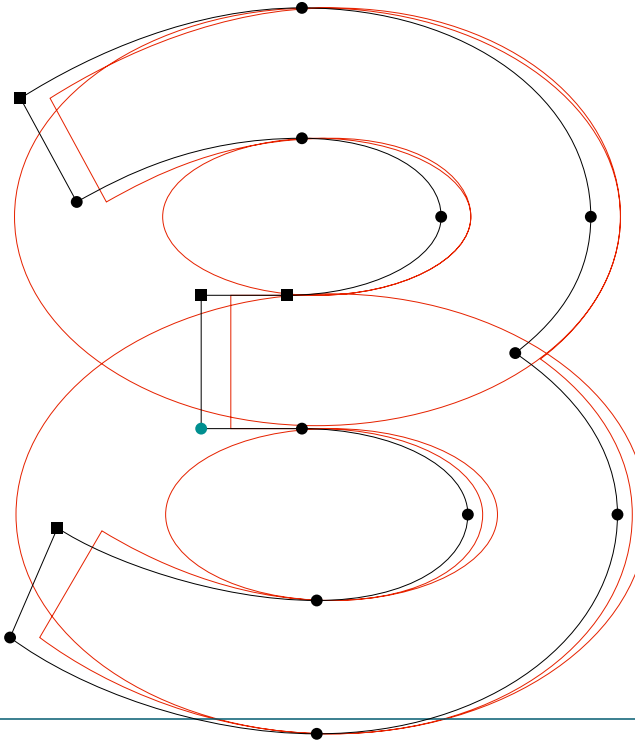
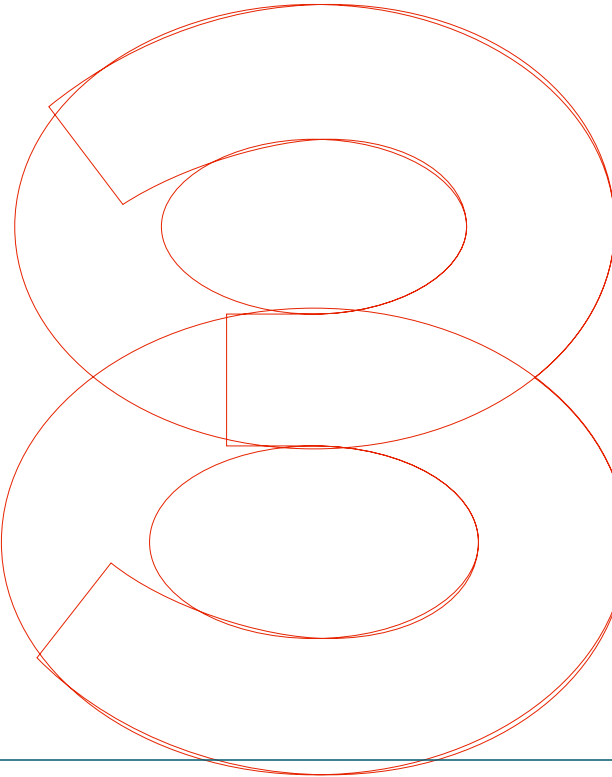

**BASE 9 & 12**

.....  
BaseNine SmallCaps | five | RoboFog Sketches | 1995 | Emigre Fonts

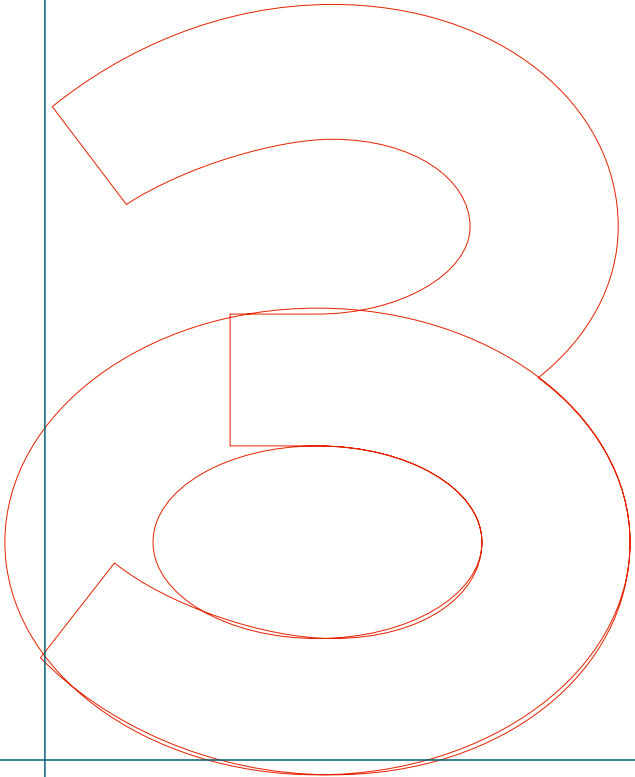
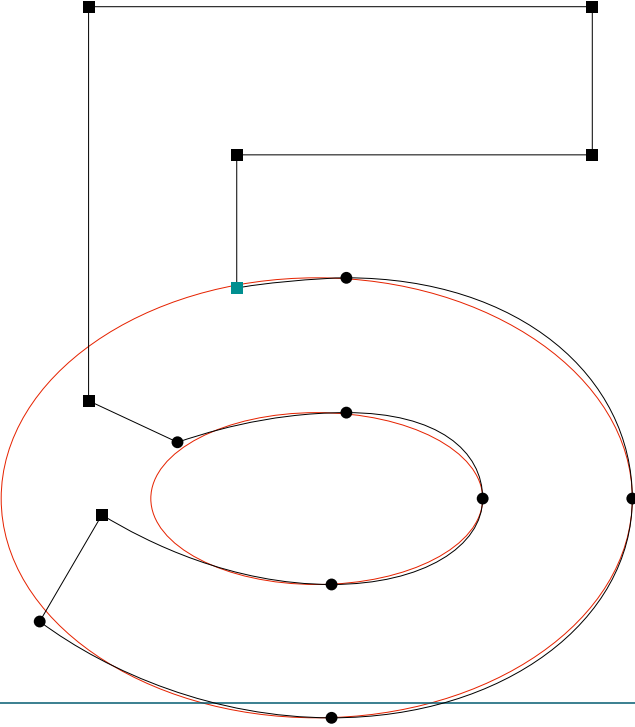
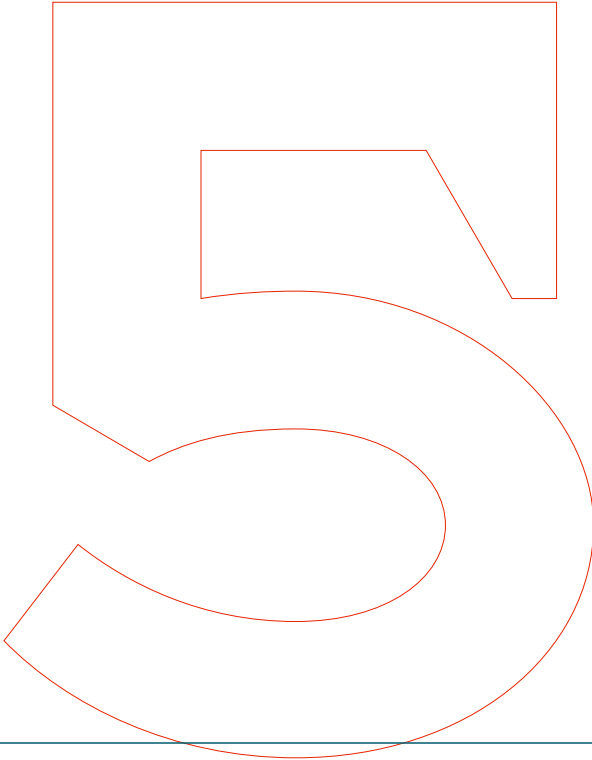

**BASE 9 & 12**

.....  
BaseNine SmallCaps | six | RoboFog Sketches | 1995 | Emigre Fonts

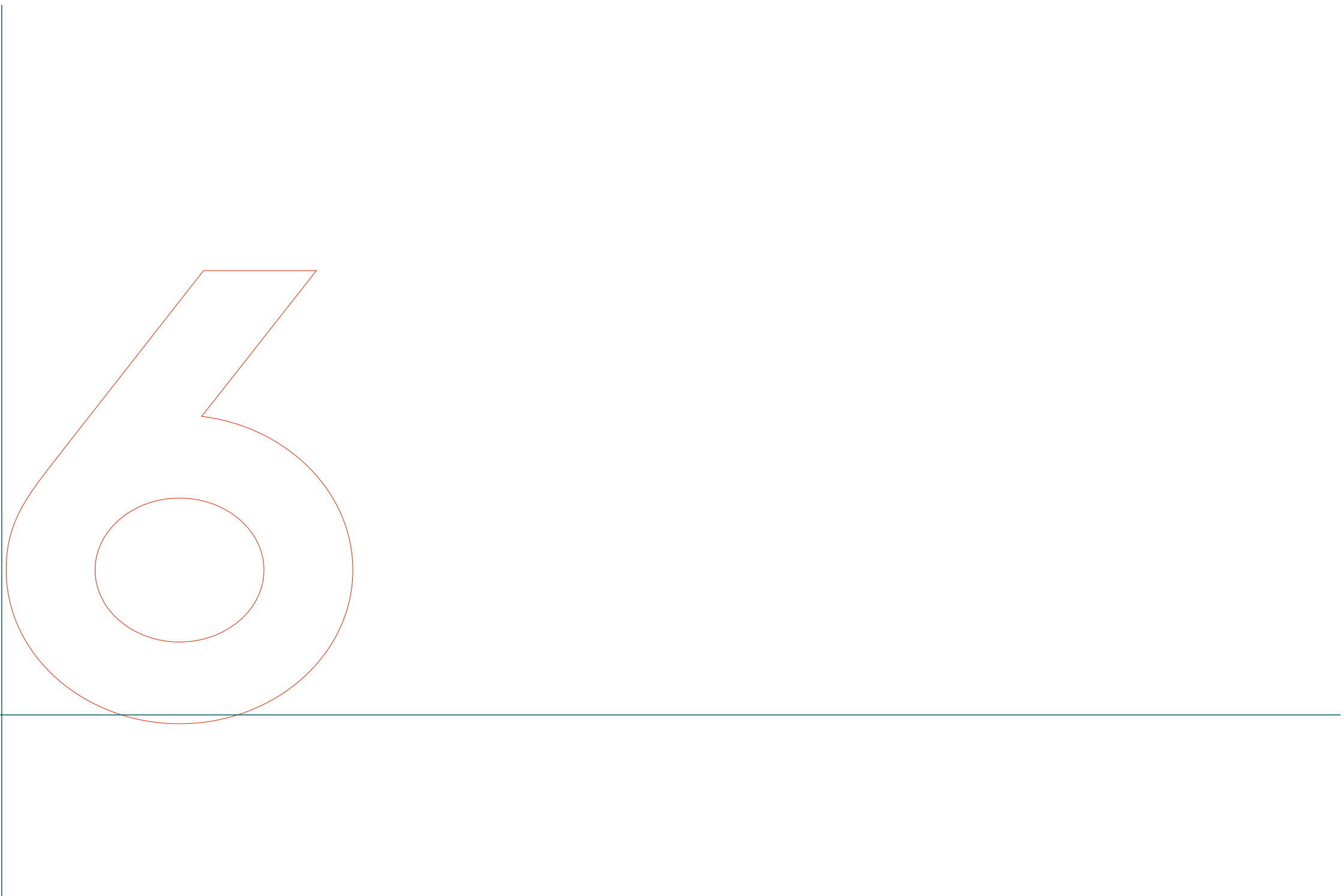
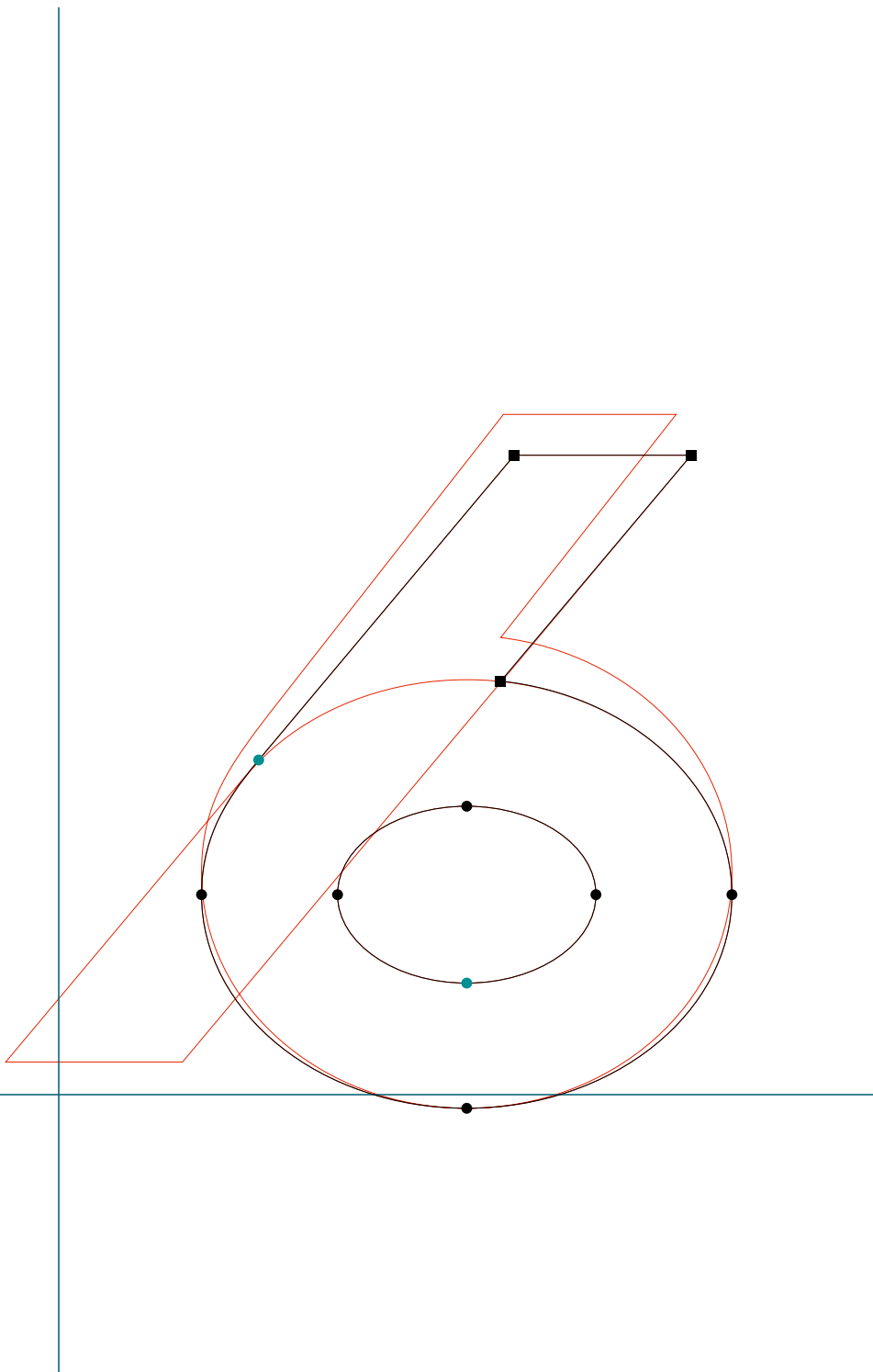



**BASE 9 & 12**

BaseNine SmallCaps | seven | RoboFog Sketches | 1995 | Emigre Fonts

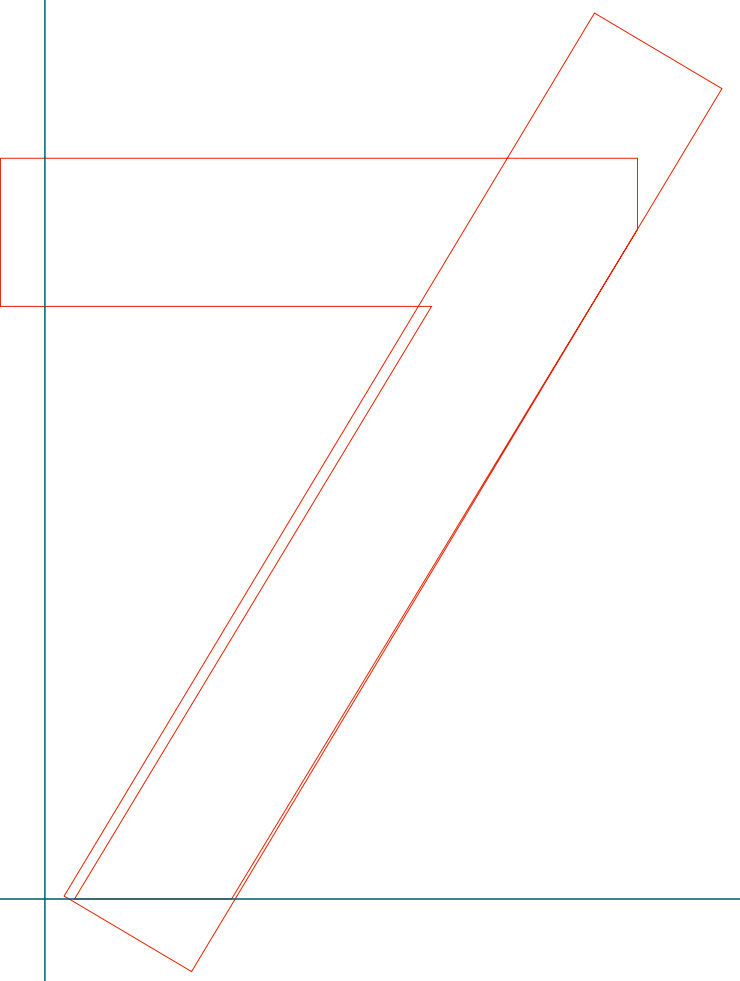
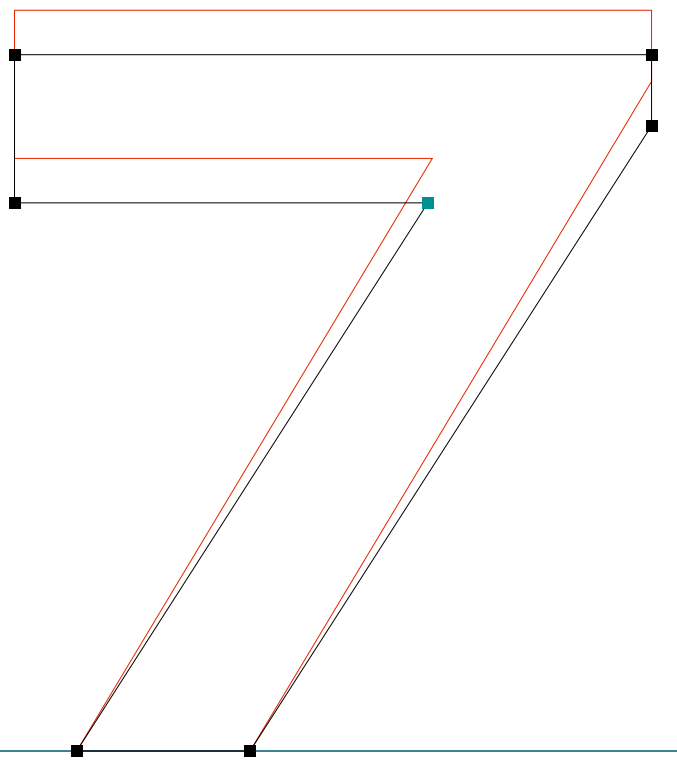

**BASE 9 & 12**

.....  
BaseNine SmallCaps | eight | RoboFog Sketches | 1995 | Emigre Fonts

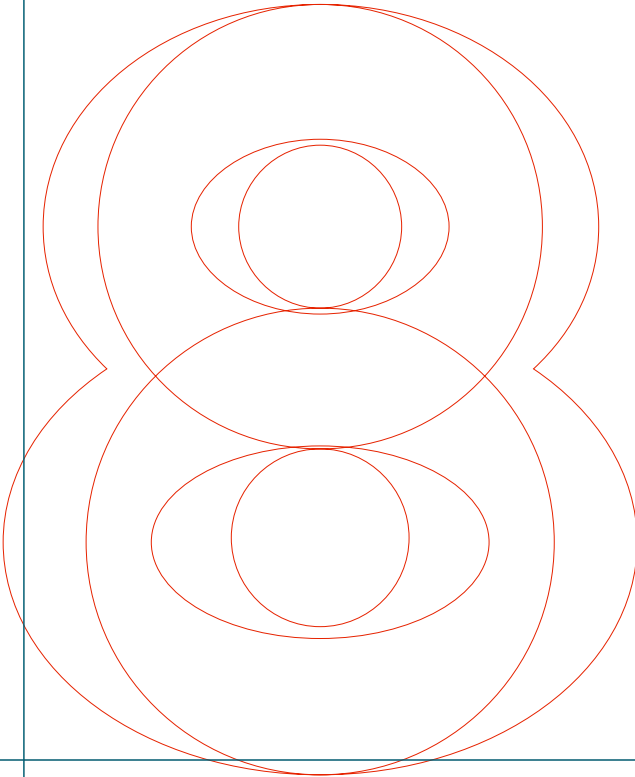
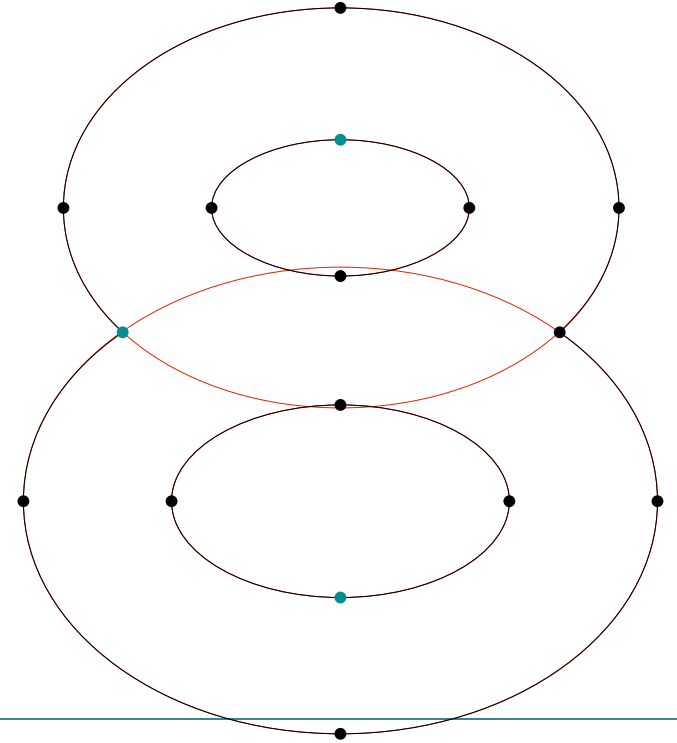
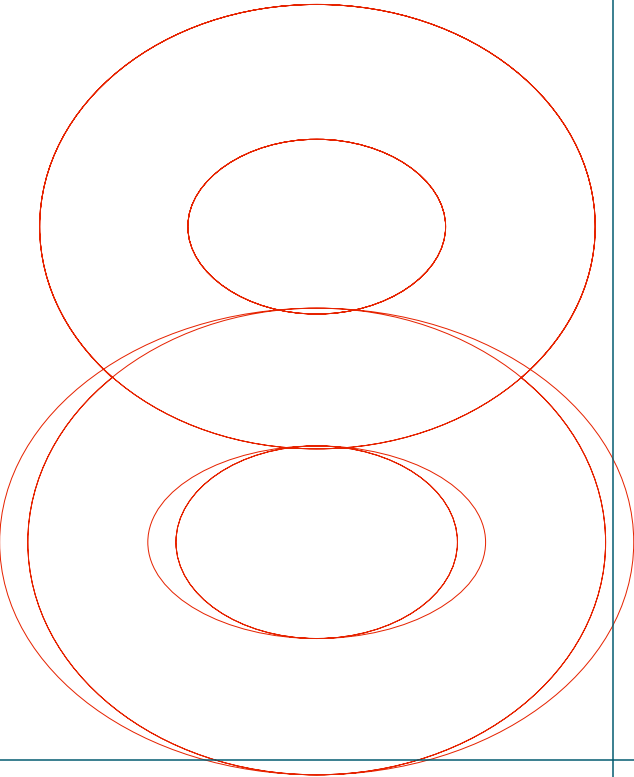

**BASE 9 & 12**

.....  
BaseNine SmallCaps | W | RoboFog Sketches | 1995 | Emigre Fonts

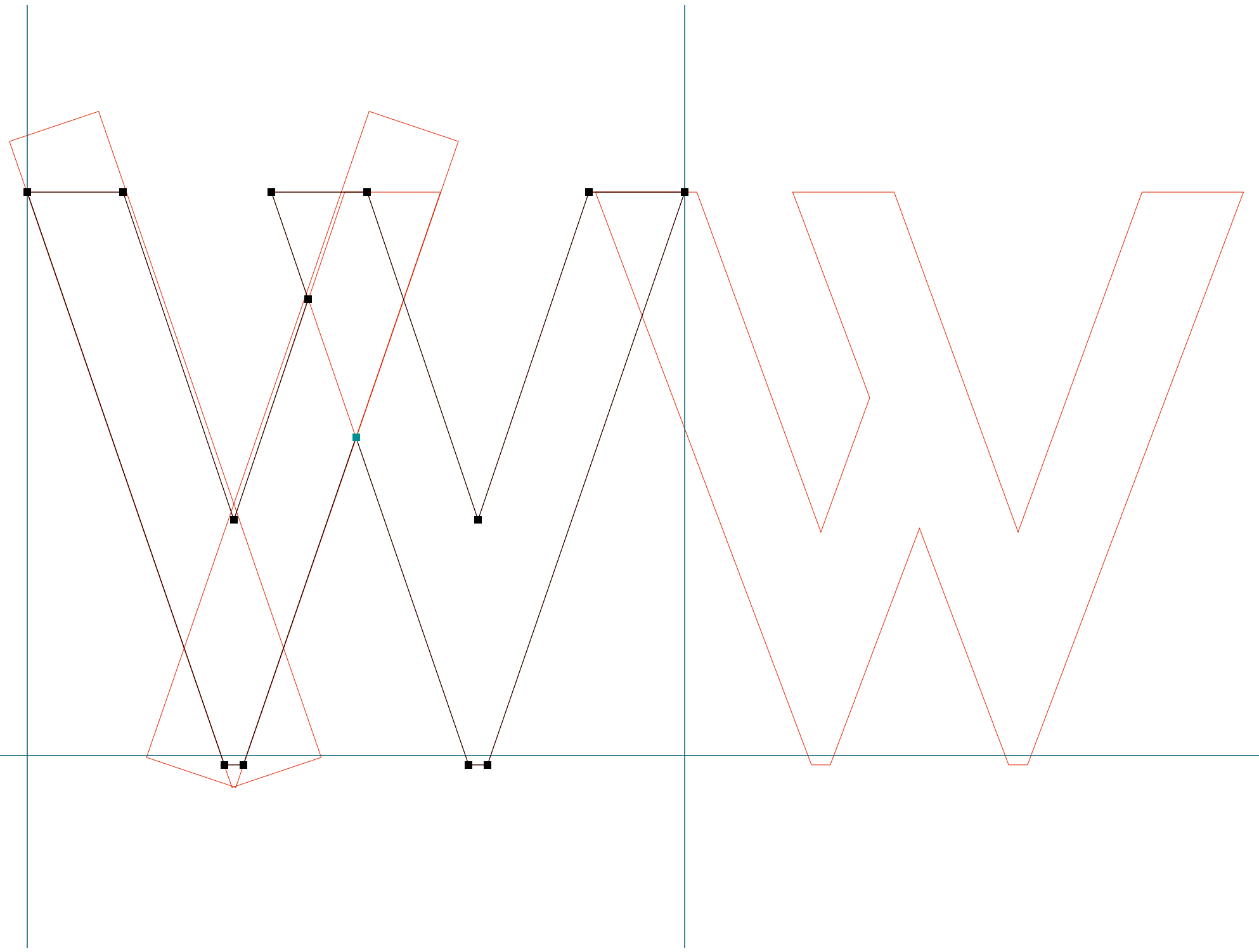

**BASE 9 & 12**

.....  
BaseNine SmallCaps | X | RoboFog Sketches | 1995 | Emigre Fonts

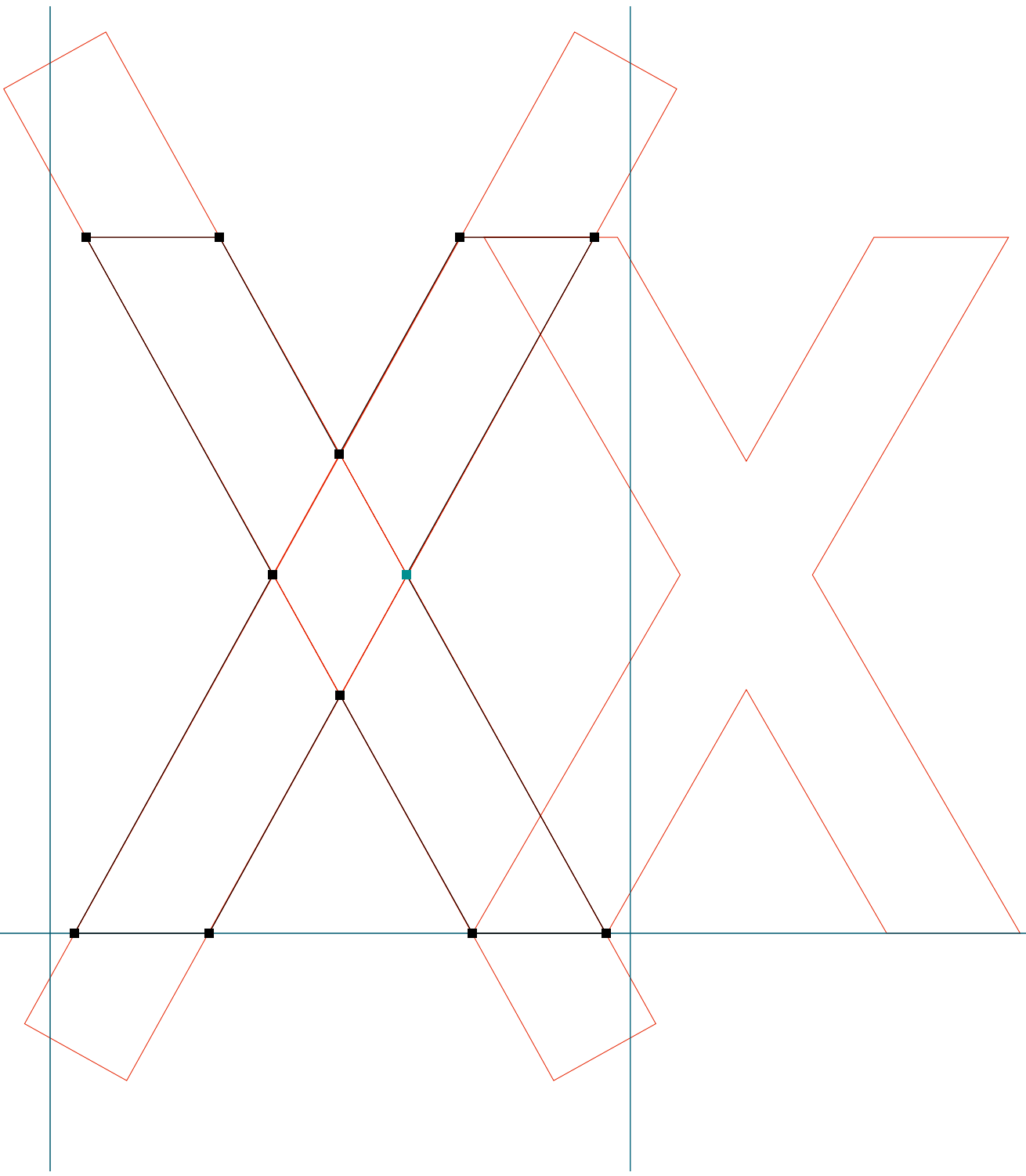

**BASE 9 & 12**

.....  
BaseNine SmallCaps | b | RoboFog Sketches | 1995 | Emigre Fonts

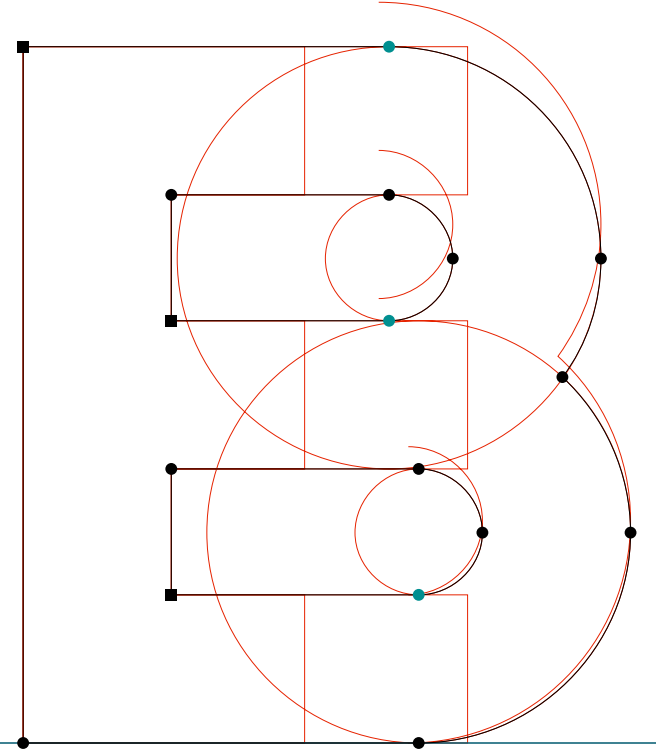

**BASE 9 & 12**

BaseNine SmallCaps | c | RoboFog Sketches | 1995 | Emigre Fonts

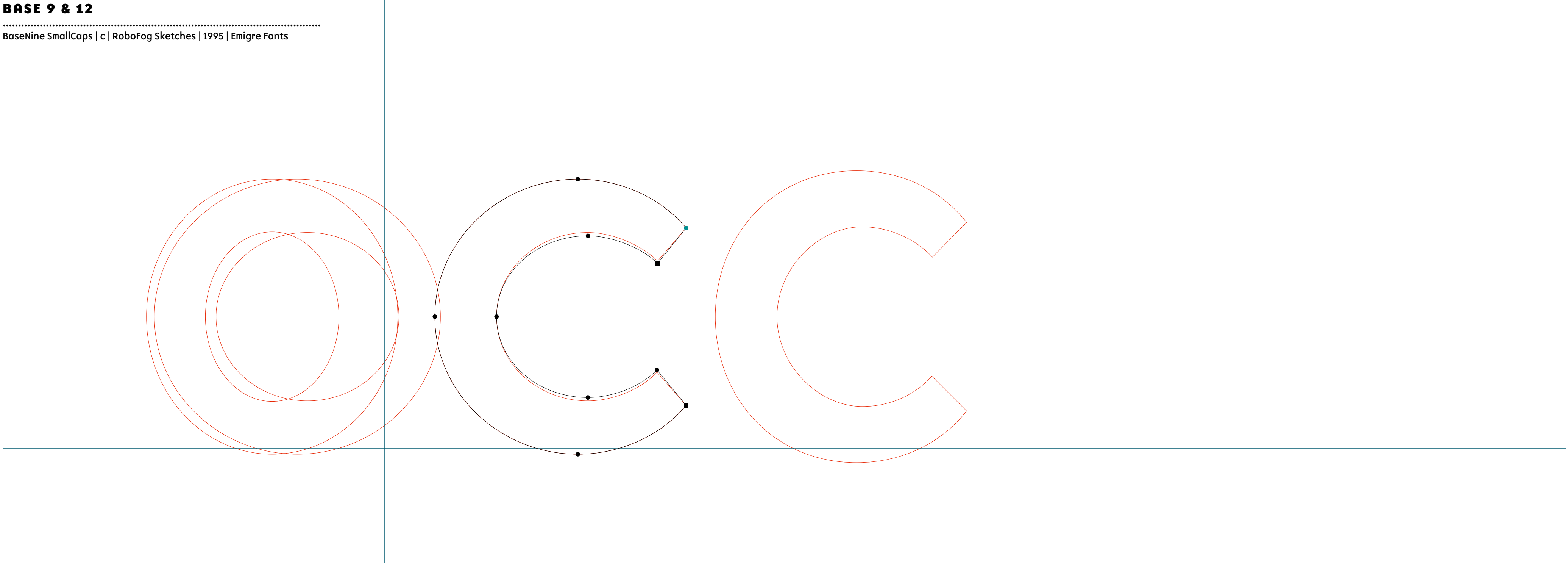



**BASE 9 & 12**

.....  
BaseNine SmallCaps | g | RoboFog Sketches | 1995 | Emigre Fonts

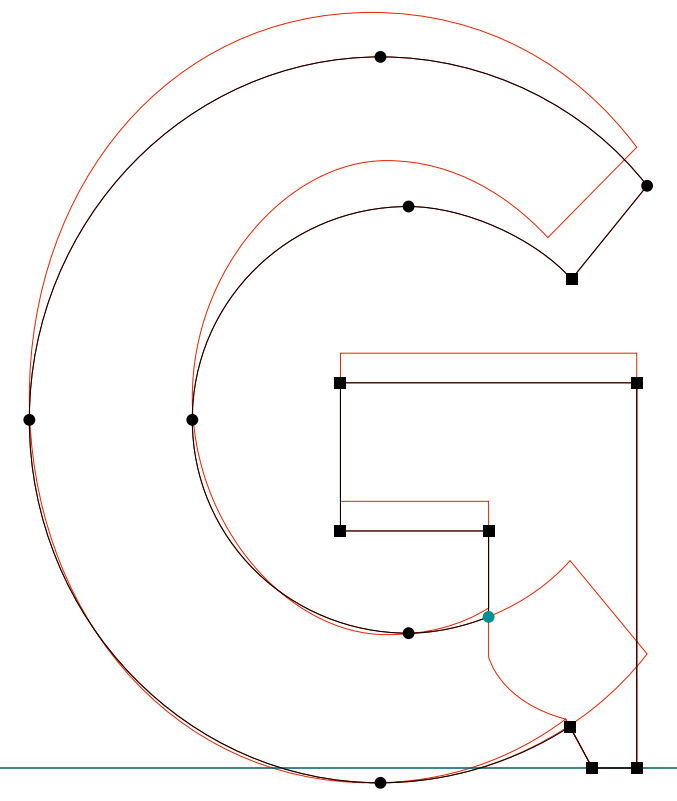



**BASE 9 & 12**

.....  
BaseNine SmallCaps | p | RoboFog Sketches | 1995 | Emigre Fonts

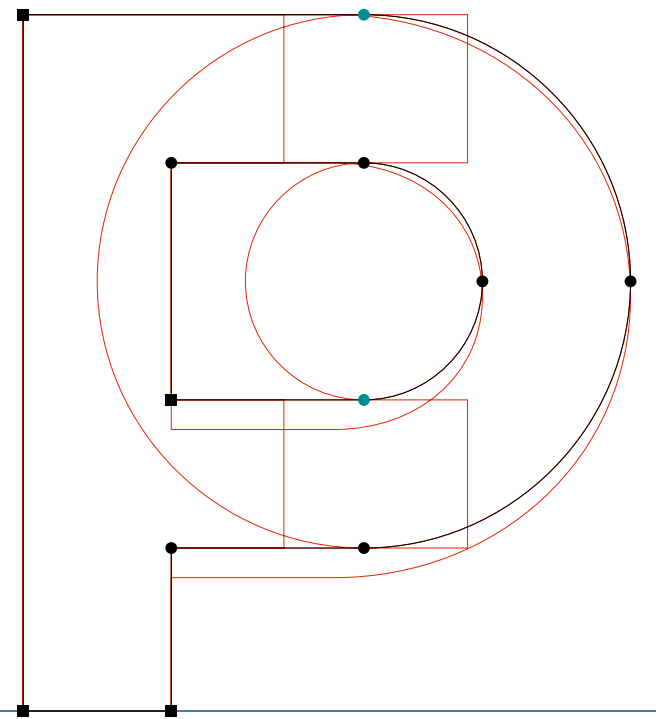

**BASE 9 & 12**

.....  
BaseNine SmallCaps | s | RoboFog Sketches | 1995 | Emigre Fonts

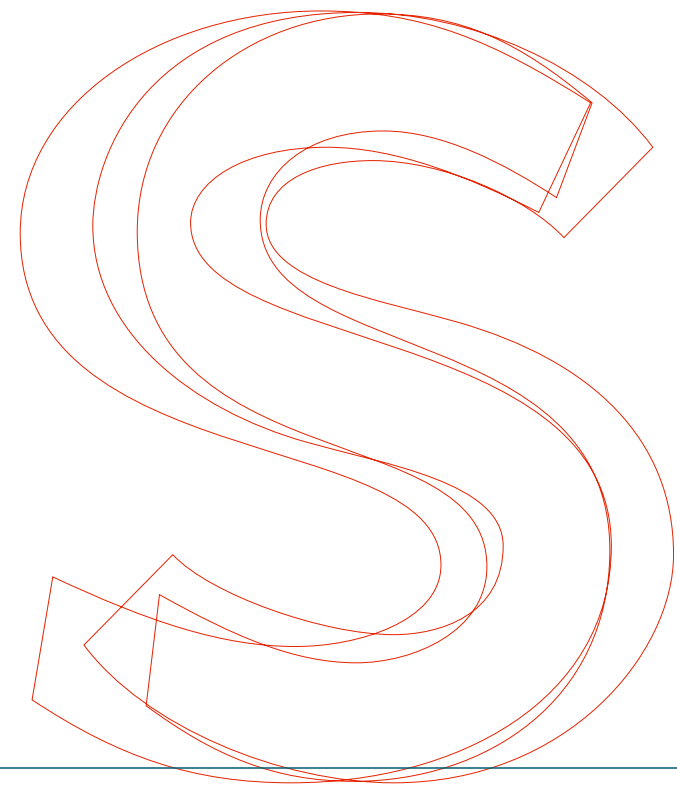
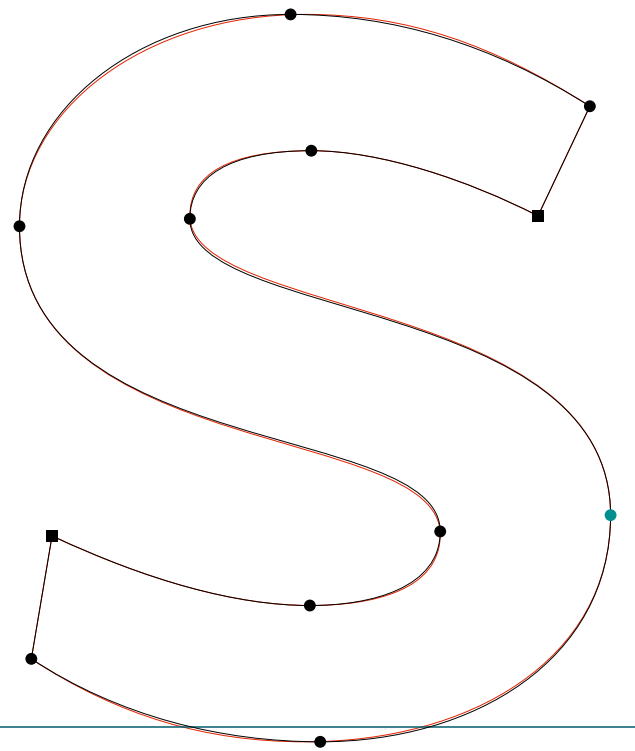
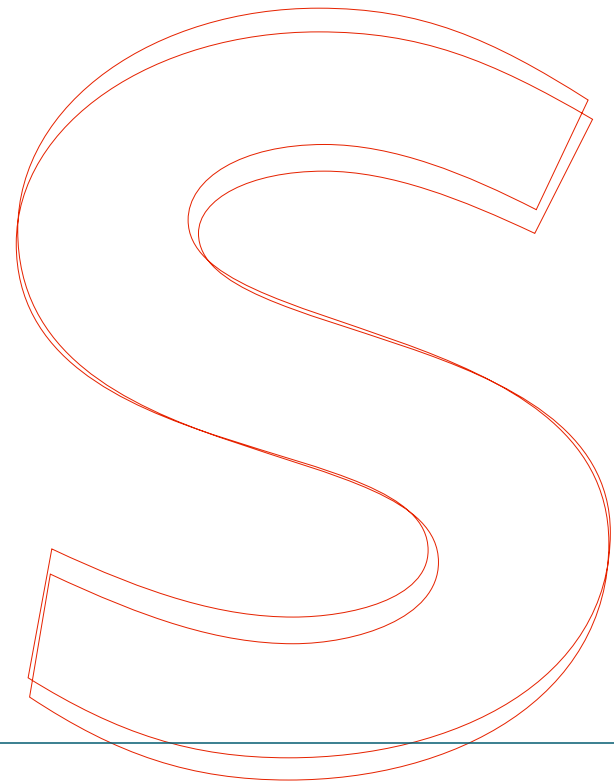

**BASE 9 & 12**

.....  
BaseNine SmallCaps | w | RoboFog Sketches | 1995 | Emigre Fonts

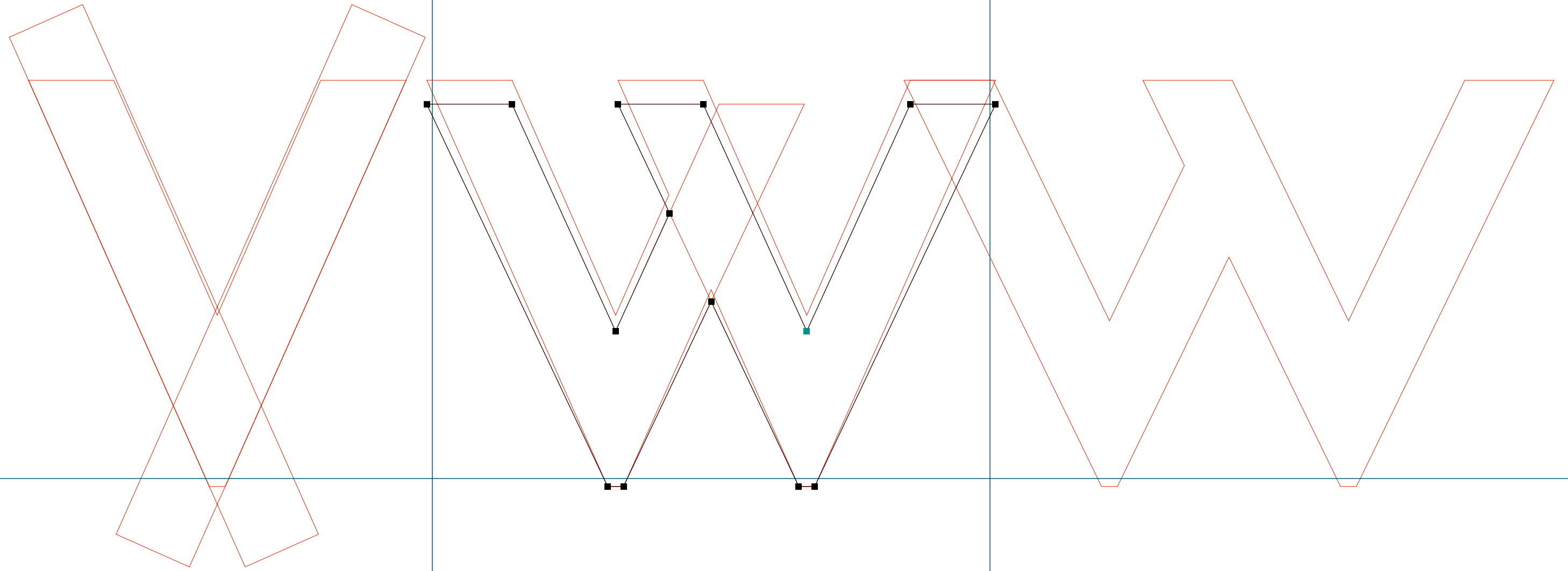

**BASE 9 & 12**

.....  
BaseNine SmallCaps | x | RoboFog Sketches | 1995 | Emigre Fonts

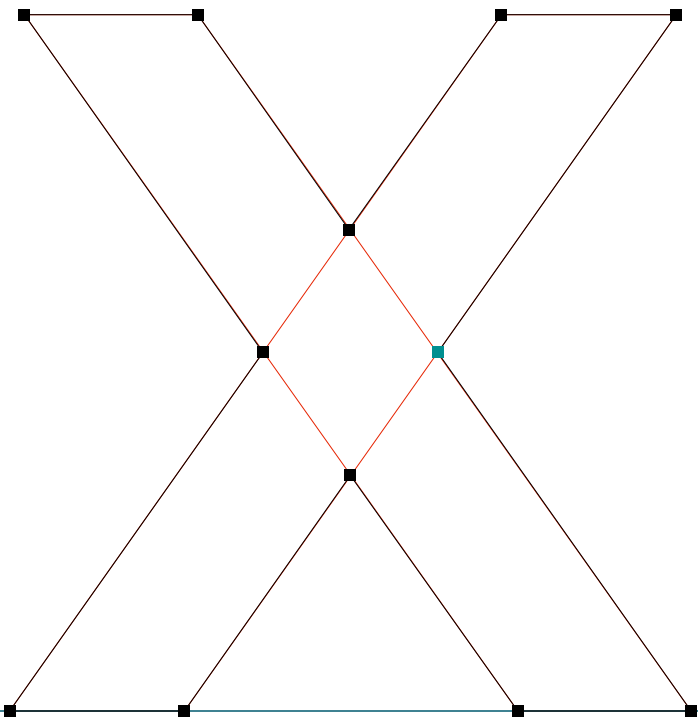
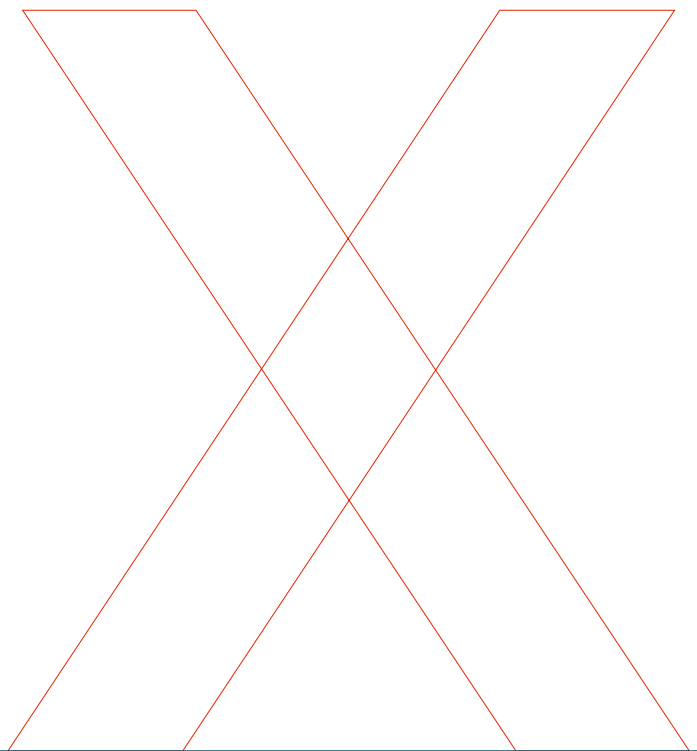

**BASE 9 & 12**

.....  
BaseNine I | six | RoboFog Sketches | 1995 | Emigre Fonts

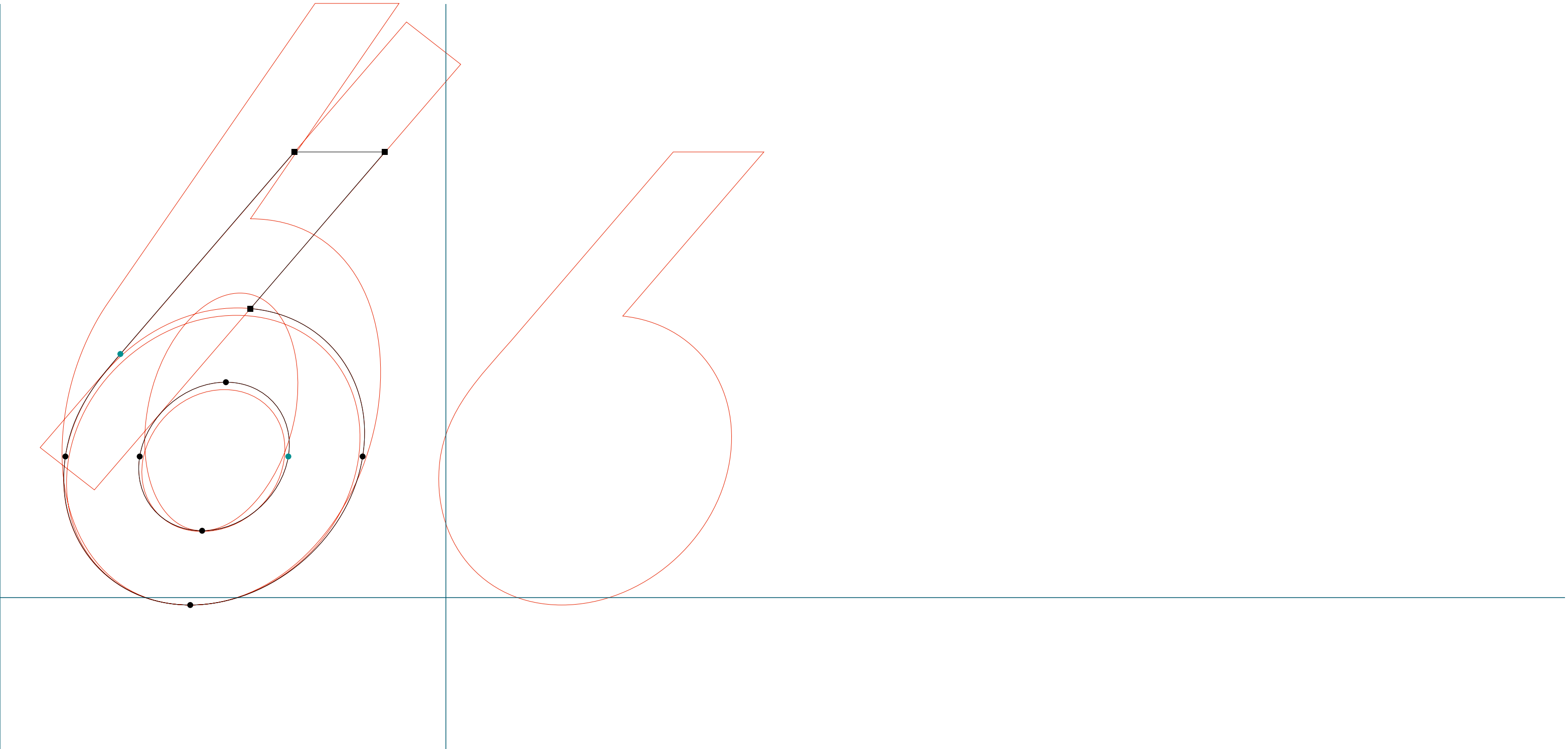

**BASE 9 & 12**

.....  
BaseNine I | A | RoboFog Sketches | 1995 | Emigre Fonts

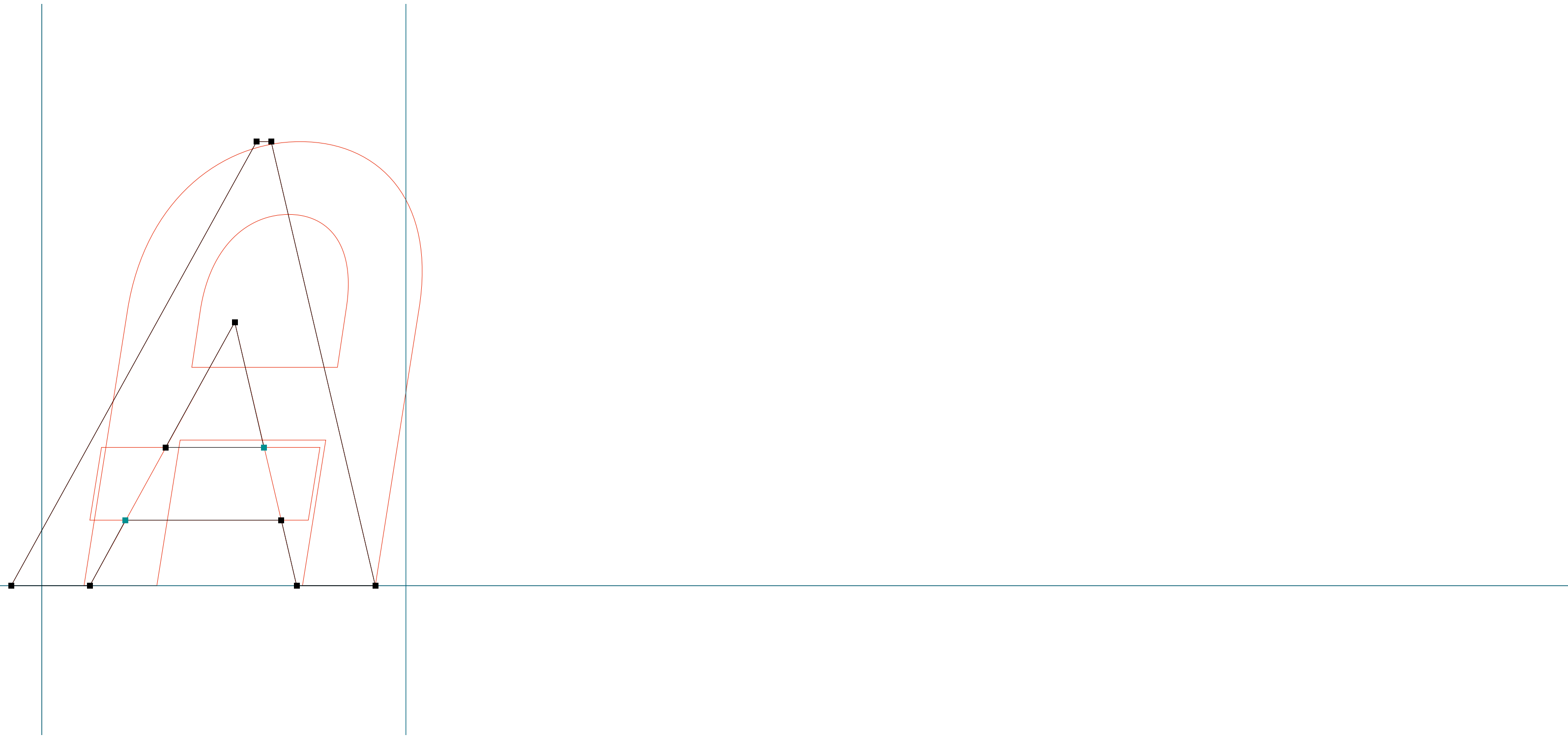

**BASE 9 & 12**

.....  
BaseNine SCI | one | RoboFog Sketches | 1995 | Emigre Fonts

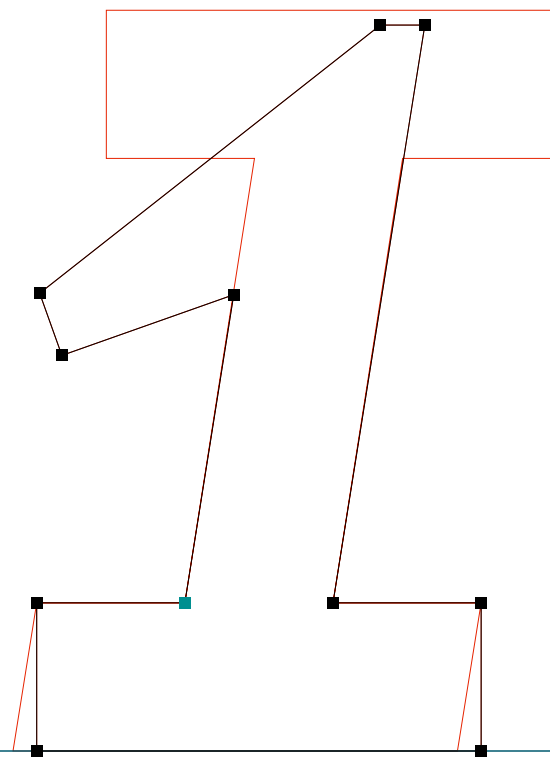

**BASE 9 & 12**

.....  
BaseNine SCI | A | RoboFog Sketches | 1995 | Emigre Fonts

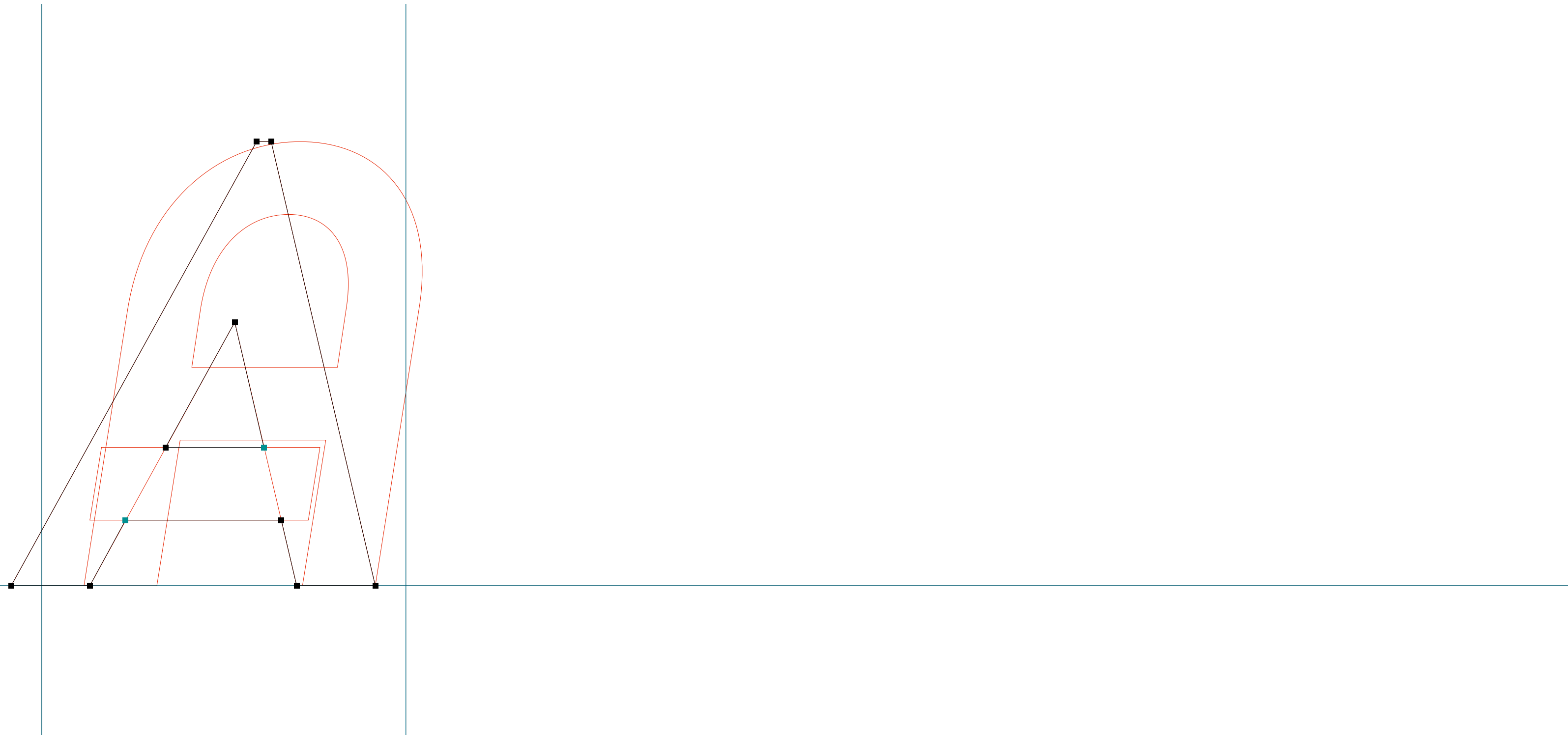



**BASE 9 & 12**

.....  
BaseNine SCI | a | RoboFog Sketches | 1995 | Emigre Fonts

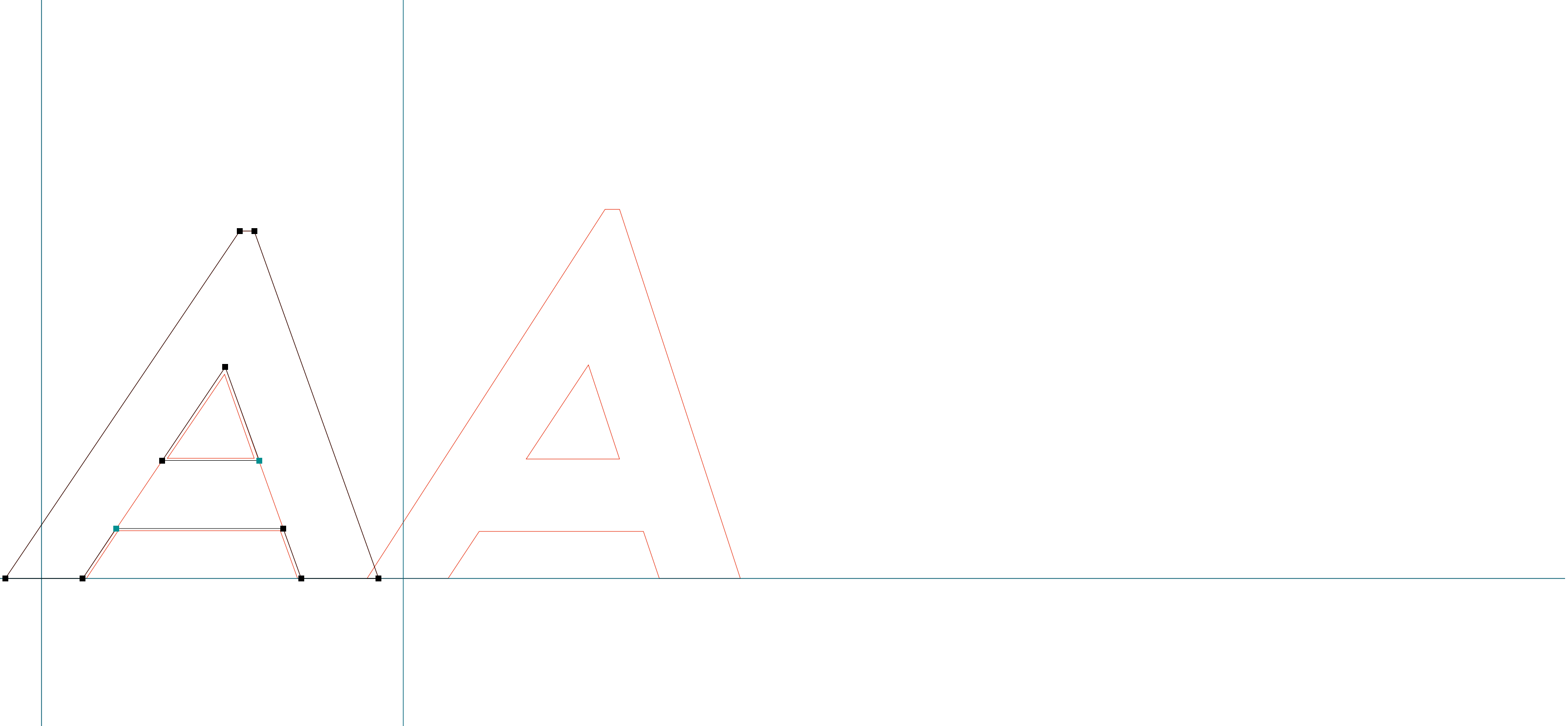

**BASE 9 & 12**

.....  
BaseNine B | hyphen | RoboFog Sketches | 1995 | Emigre Fonts

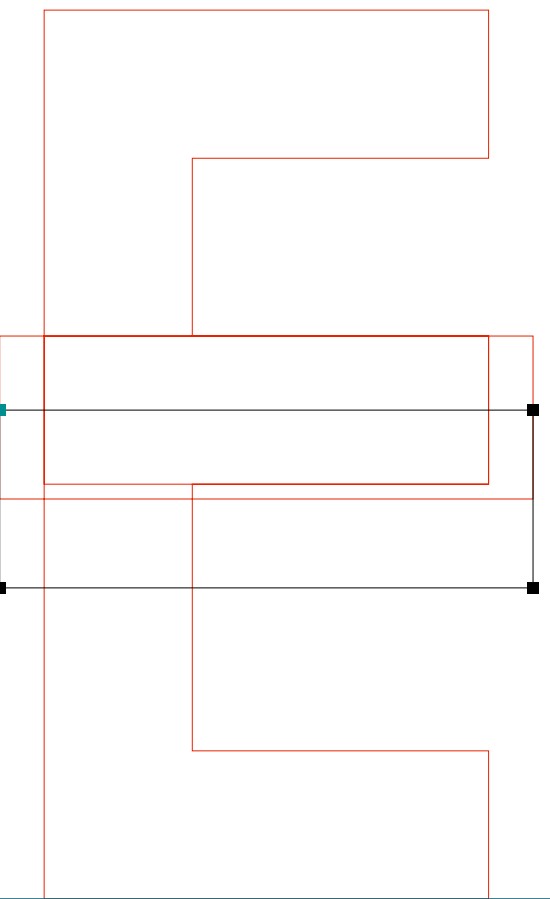

**BASE 9 & 12**

BaseNine B | five | RoboFog Sketches | 1995 | Emigre Fonts

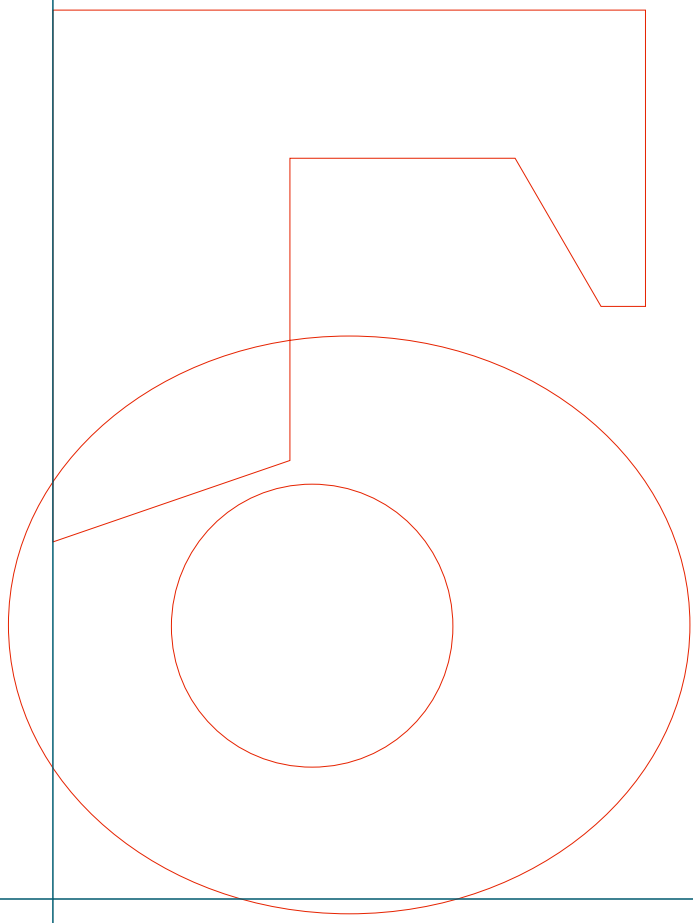
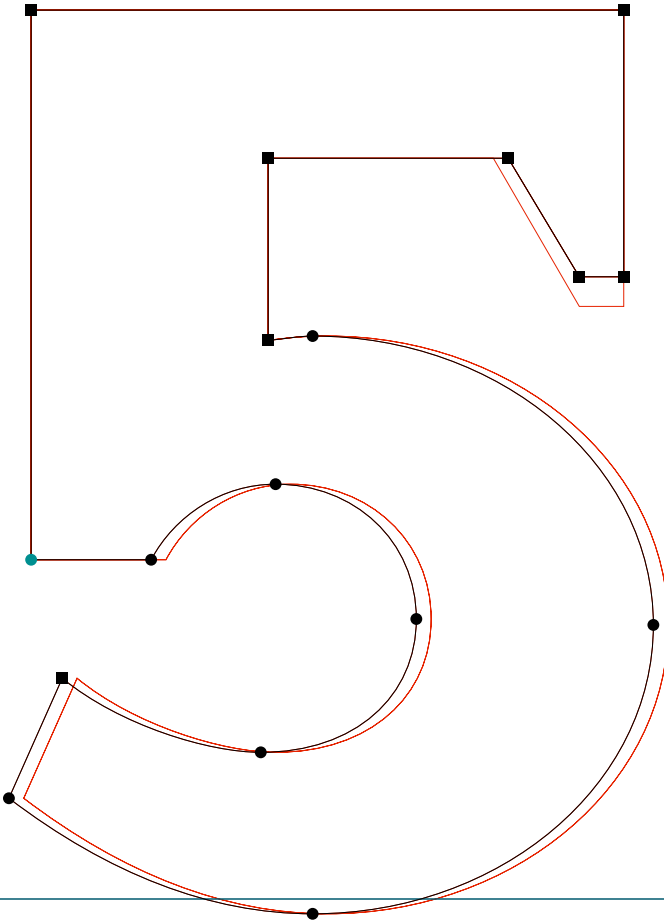

**BASE 9 & 12**

.....  
BaseNine B | six | RoboFog Sketches | 1995 | Emigre Fonts

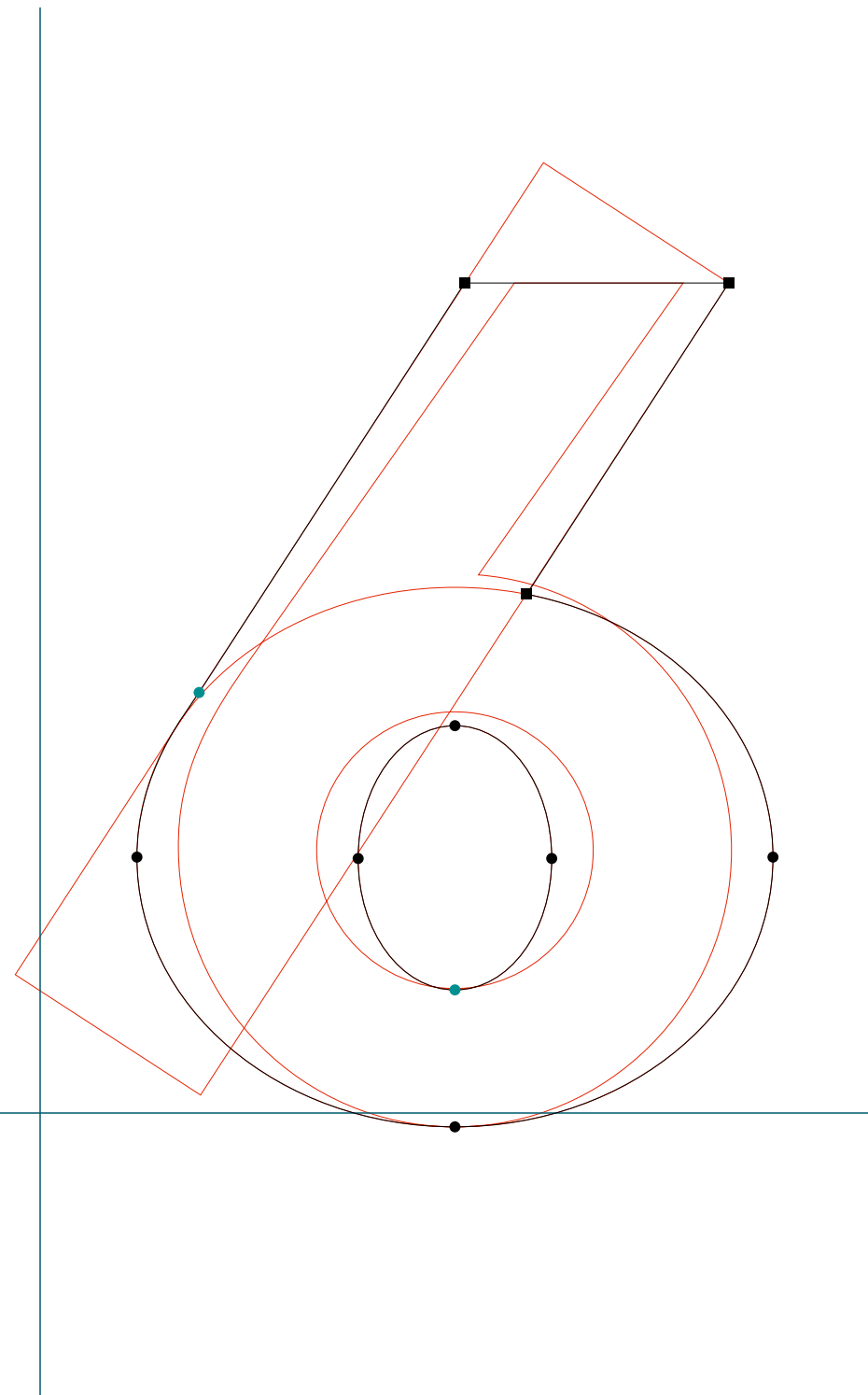

**BASE 9 & 12**

.....  
BaseNine B | eight | RoboFog Sketches | 1995 | Emigre Fonts

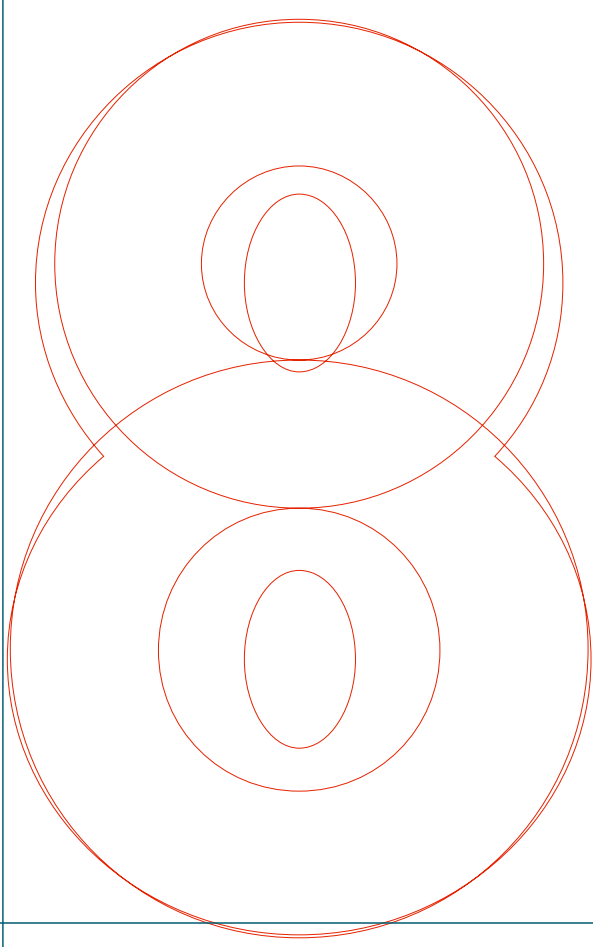
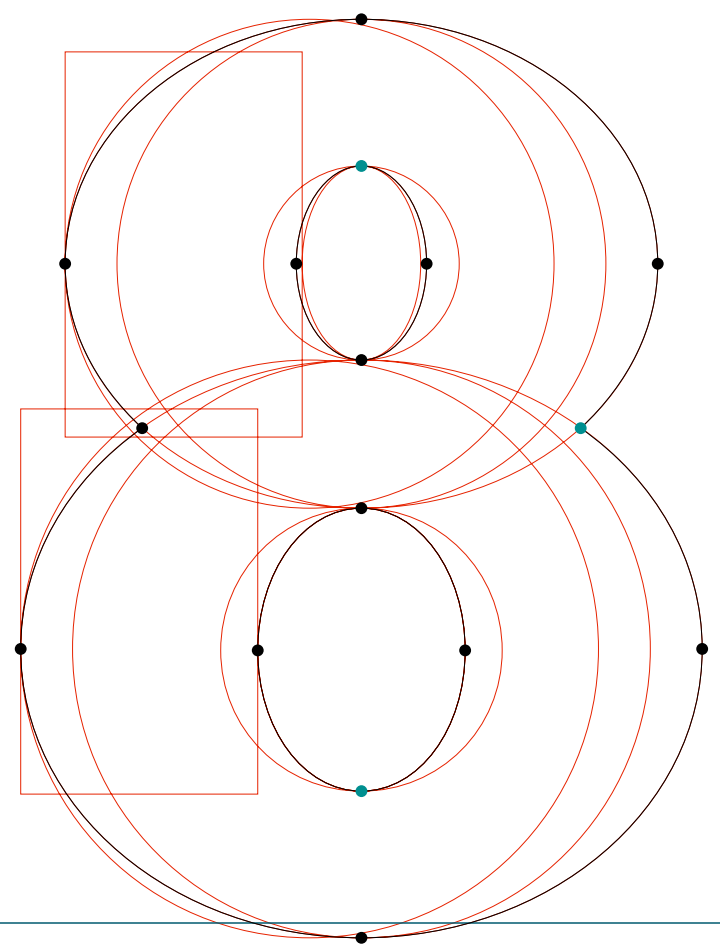

**BASE 9 & 12**

.....  
BaseNine B | B | RoboFog Sketches | 1995 | Emigre Fonts

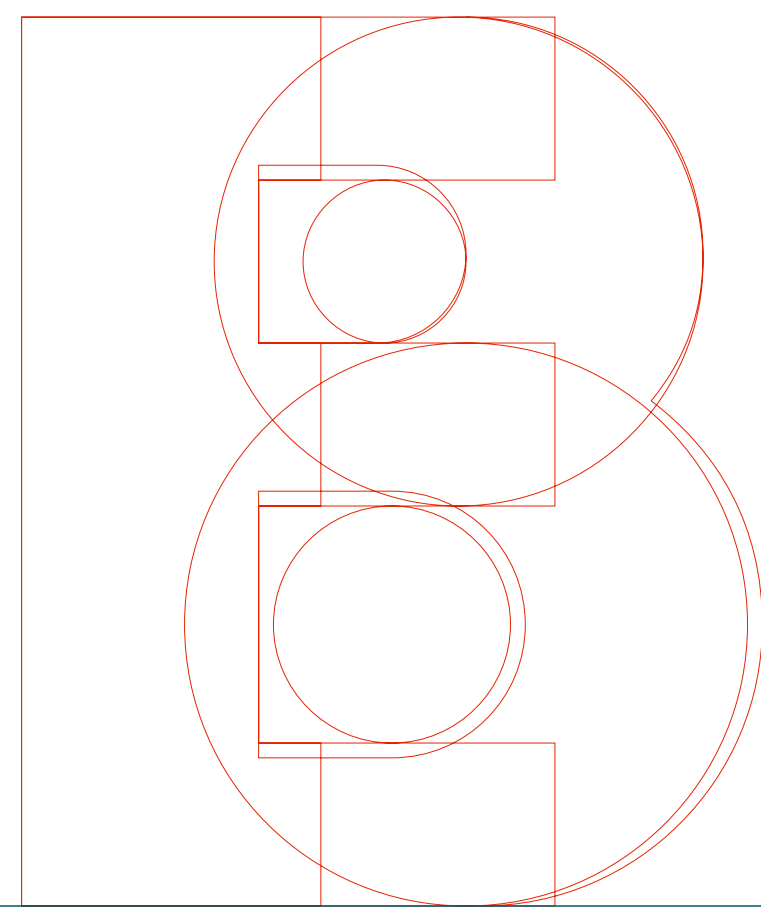
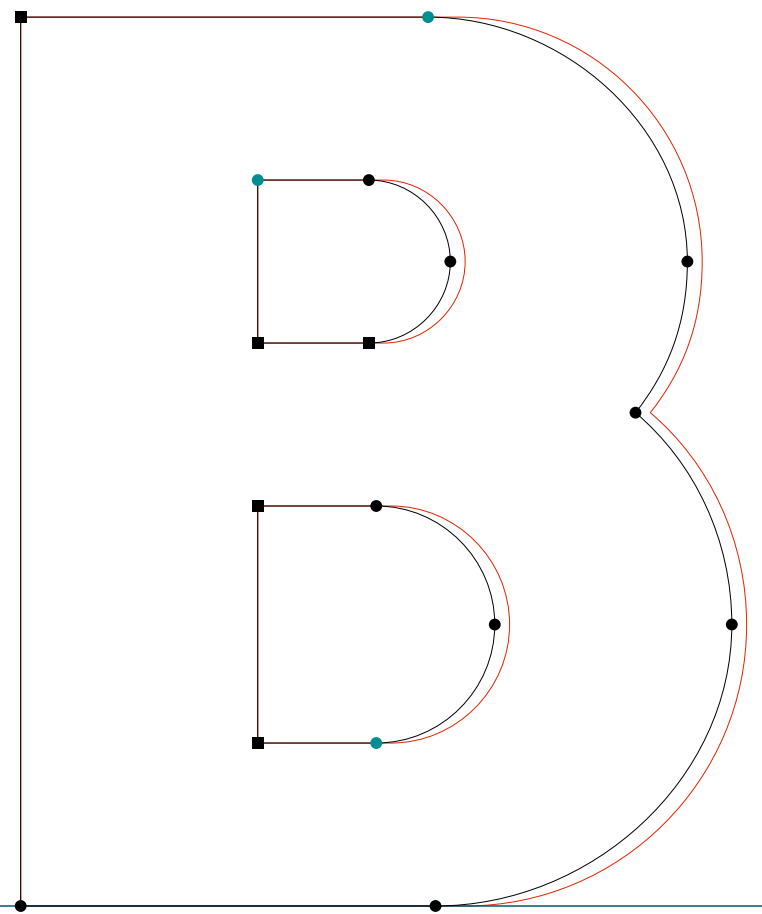

**BASE 9 & 12**

.....  
BaseNine B | J | RoboFog Sketches | 1995 | Emigre Fonts

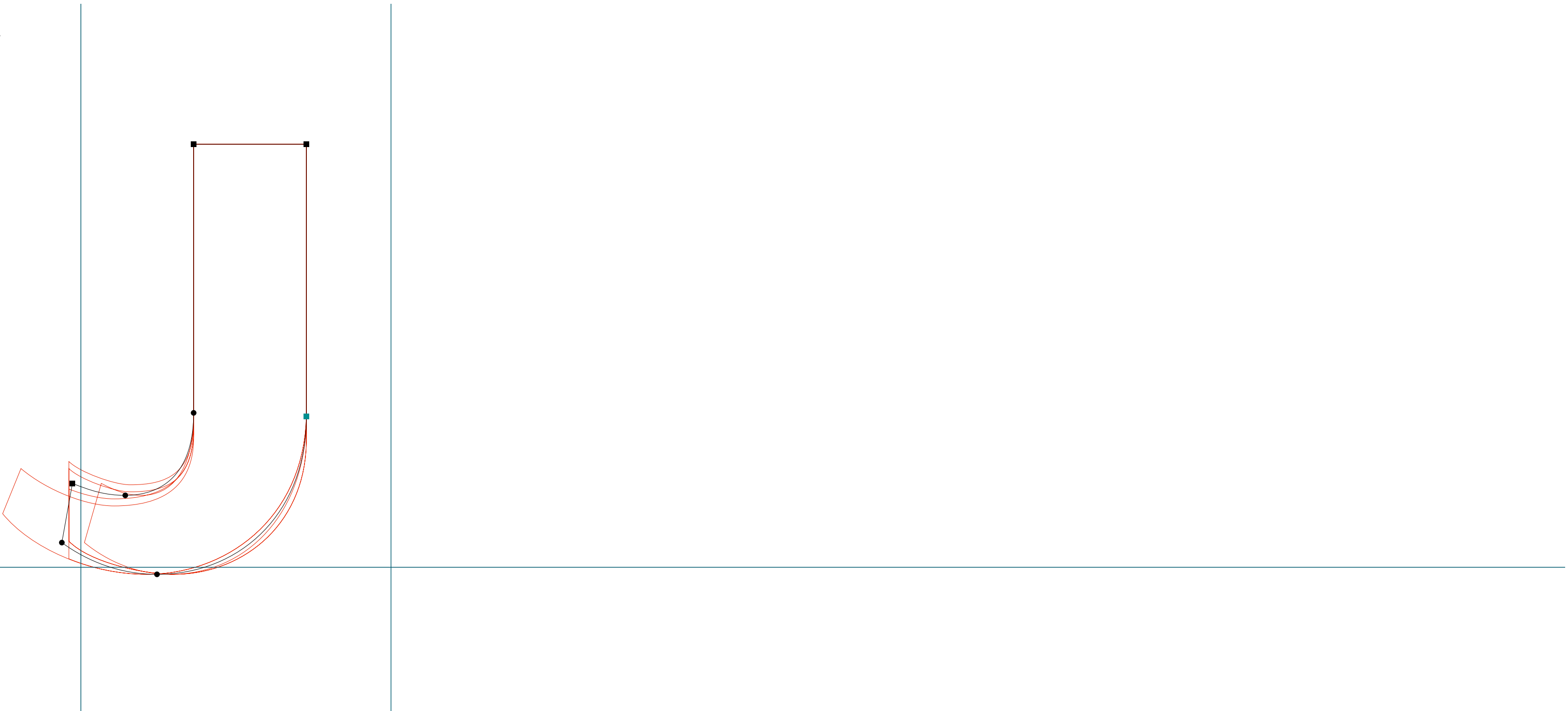

**BASE 9 & 12**

.....  
BaseNine B | L | RoboFog Sketches | 1995 | Emigre Fonts

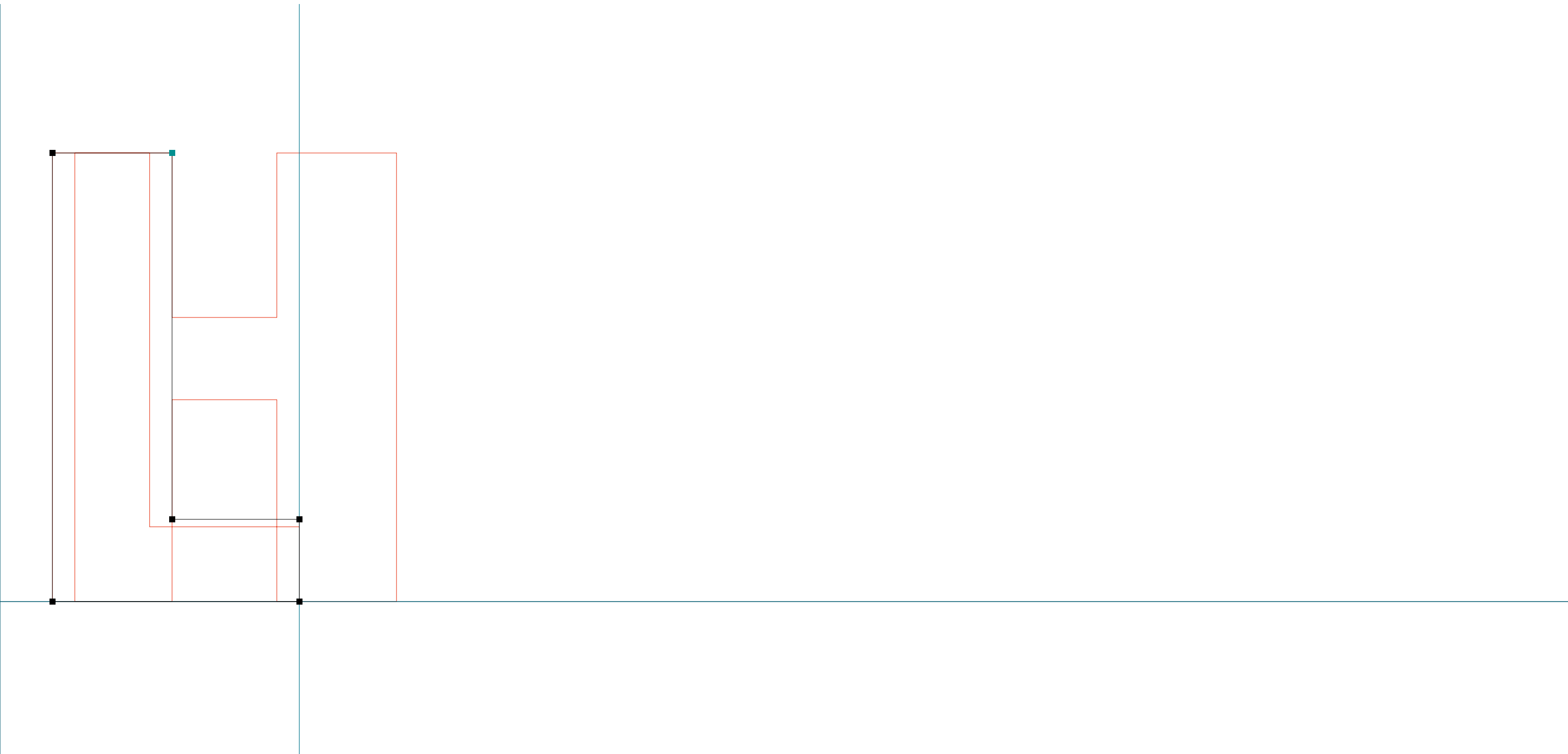



**BASE 9 & 12**

.....  
BaseNine B | M | RoboFog Sketches | 1995 | Emigre Fonts

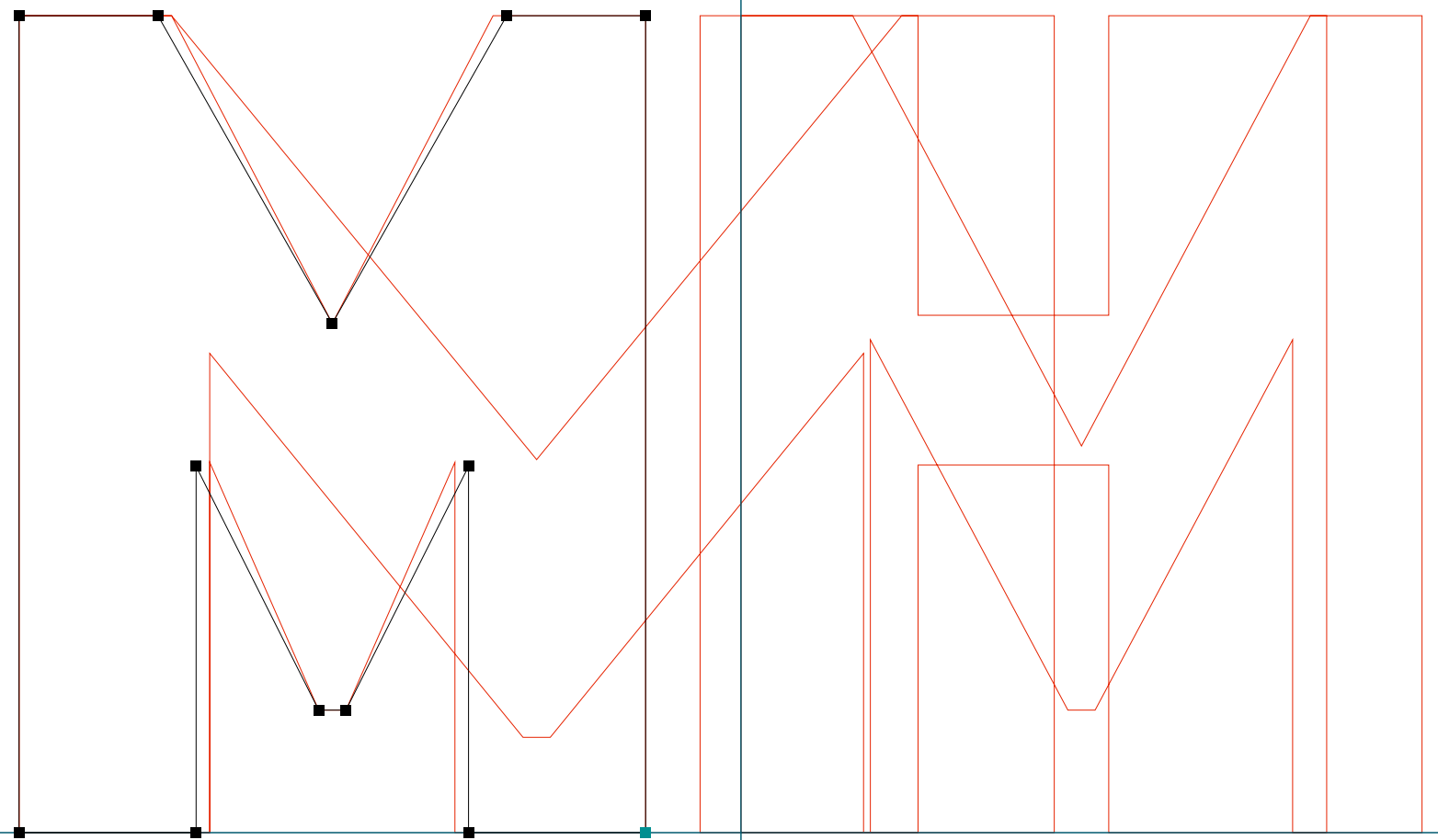

**BASE 9 & 12**

.....  
BaseNine B | N | RoboFog Sketches | 1995 | Emigre Fonts

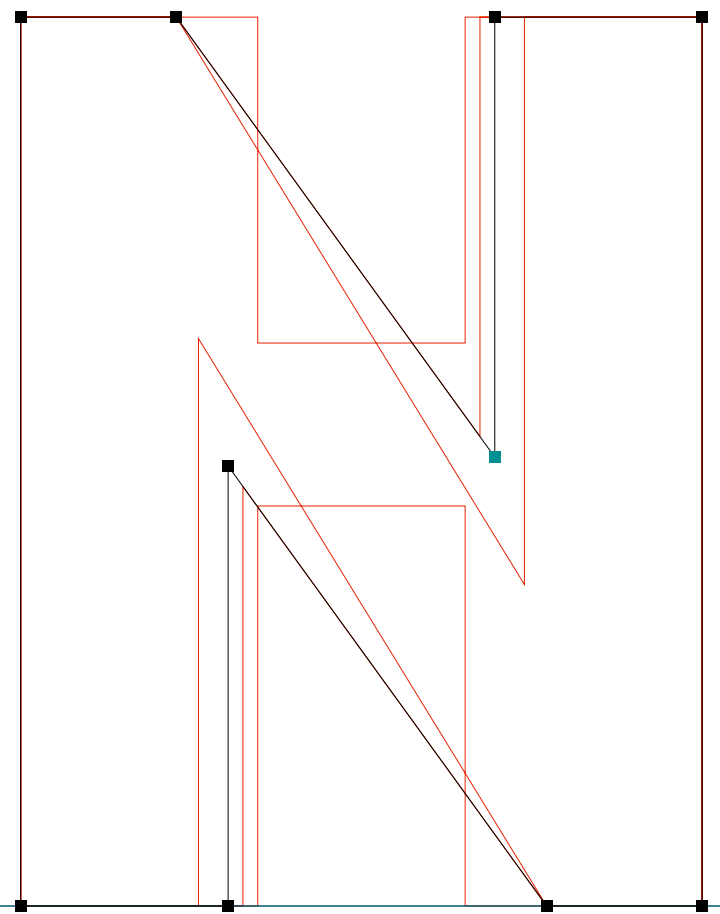

**BASE 9 & 12**

.....  
BaseNine B | Q | RoboFog Sketches | 1995 | Emigre Fonts

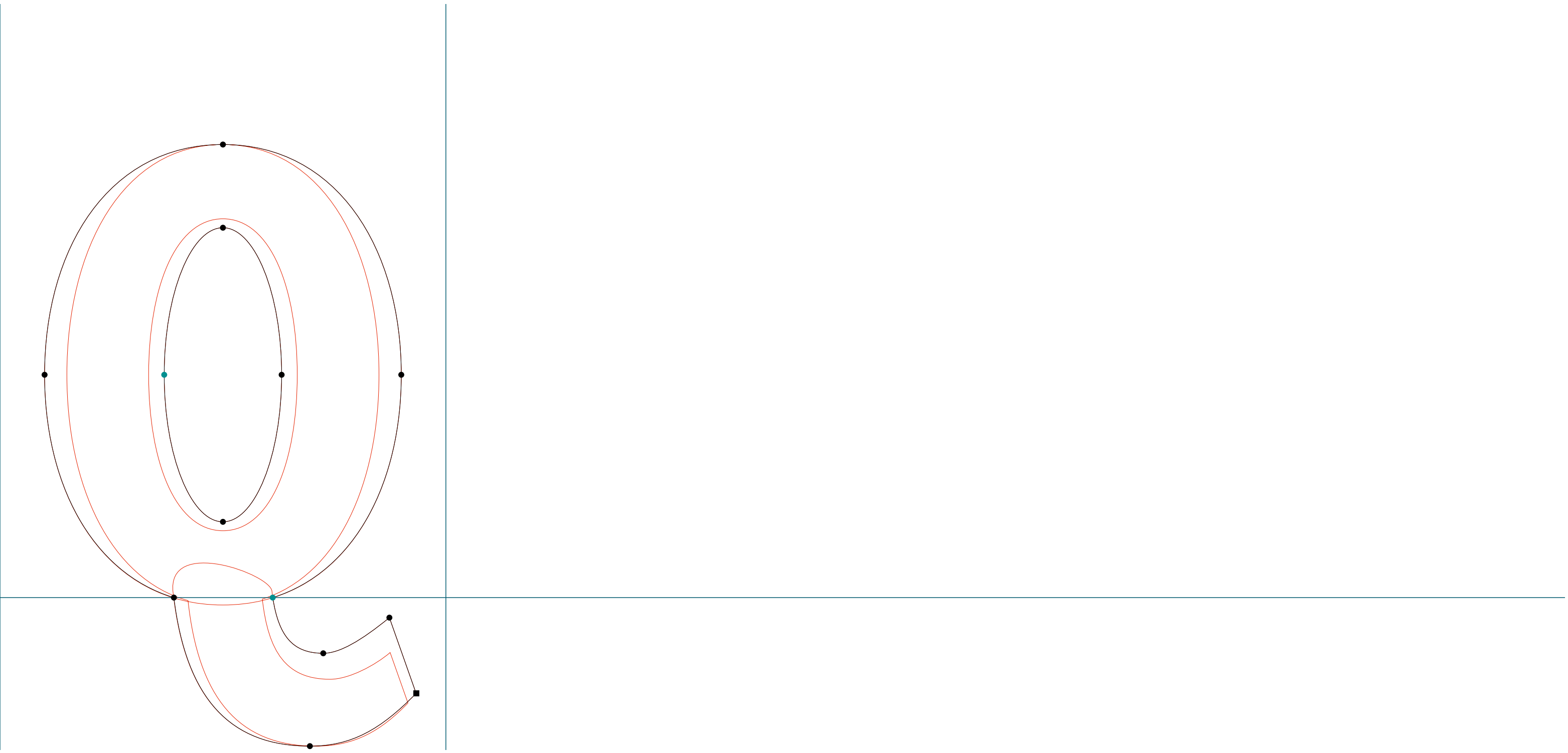

**BASE 9 & 12**

.....  
BaseNine B | V | RoboFog Sketches | 1995 | Emigre Fonts

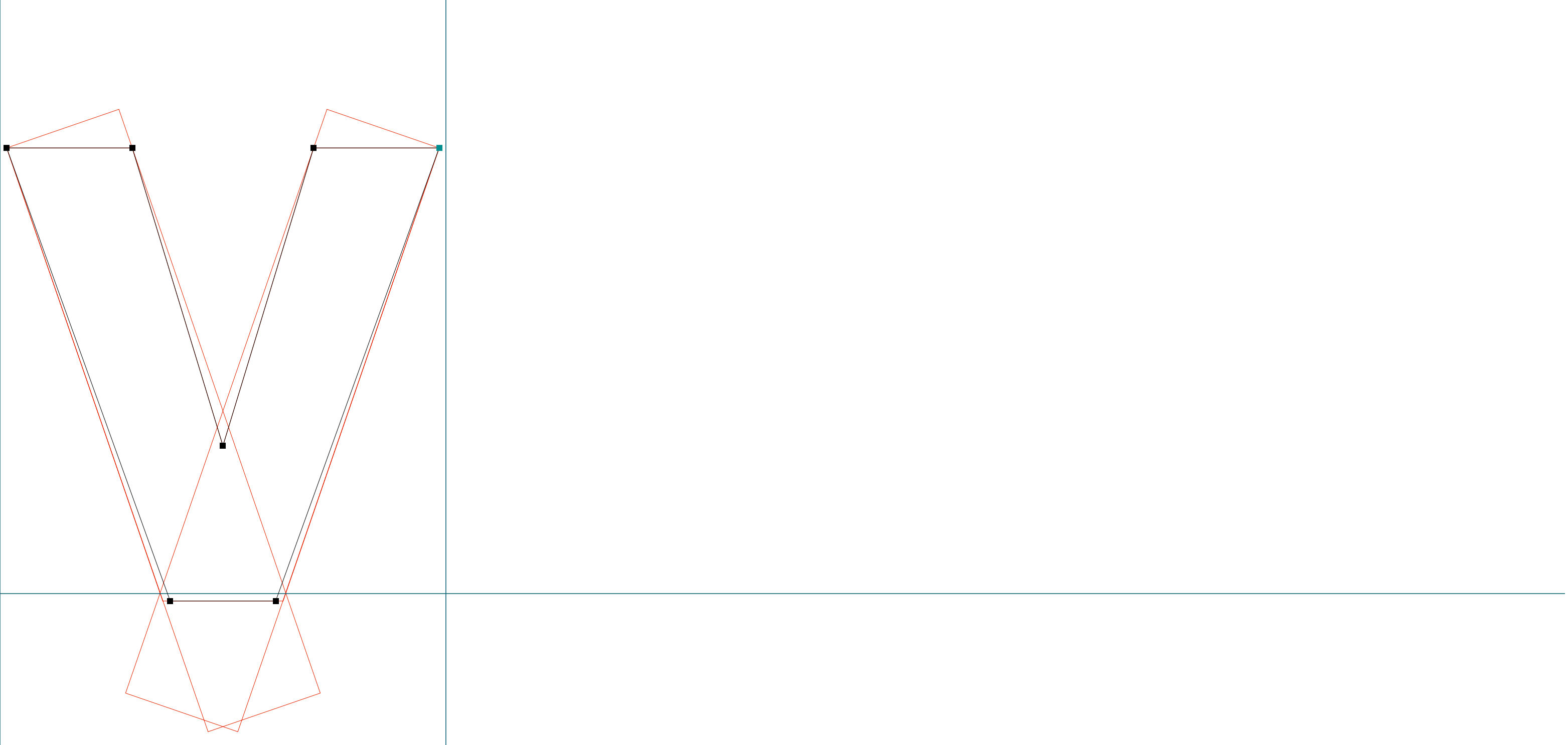

**BASE 9 & 12**

BaseNine B | a | RoboFog Sketches | 1995 | Emigre Fonts

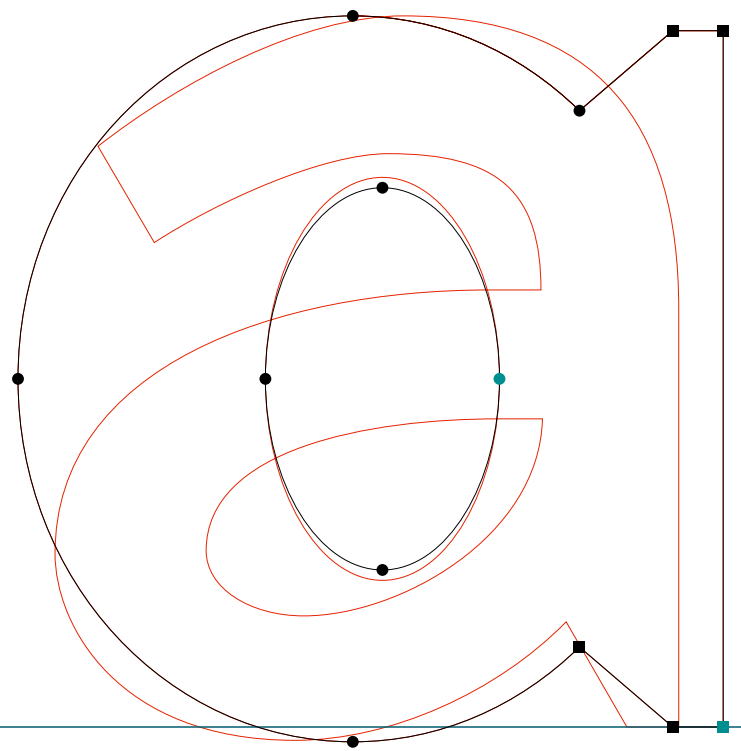

**BASE 9 & 12**

.....  
BaseNine B | b | RoboFog Sketches | 1995 | Emigre Fonts

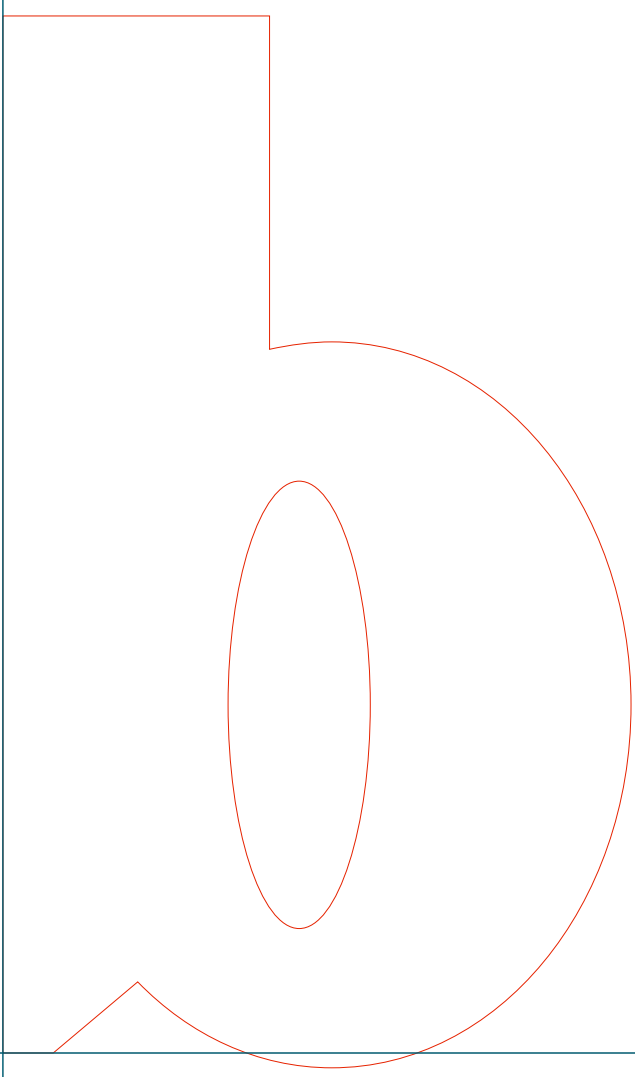
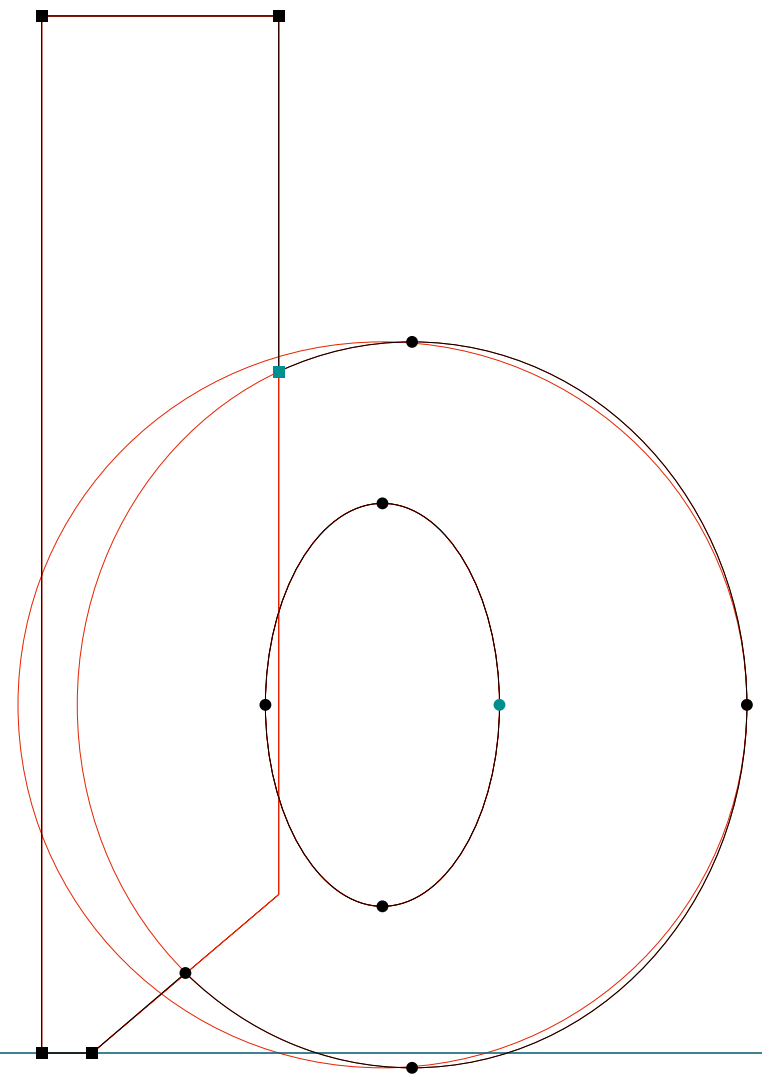

**BASE 9 & 12**

BaseNine B | c | RoboFog Sketches | 1995 | Emigre Fonts

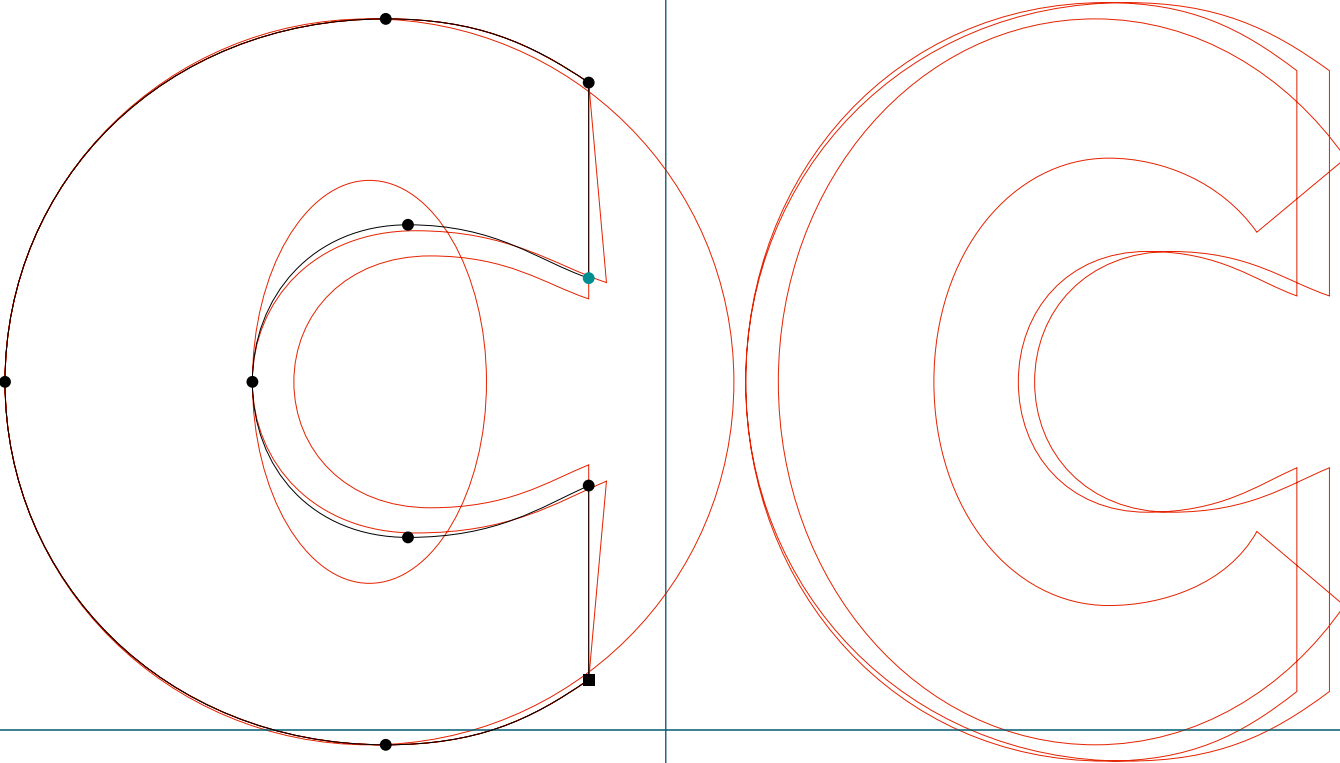

**BASE 9 & 12**

.....  
BaseNine B | e | RoboFog Sketches | 1995 | Emigre Fonts

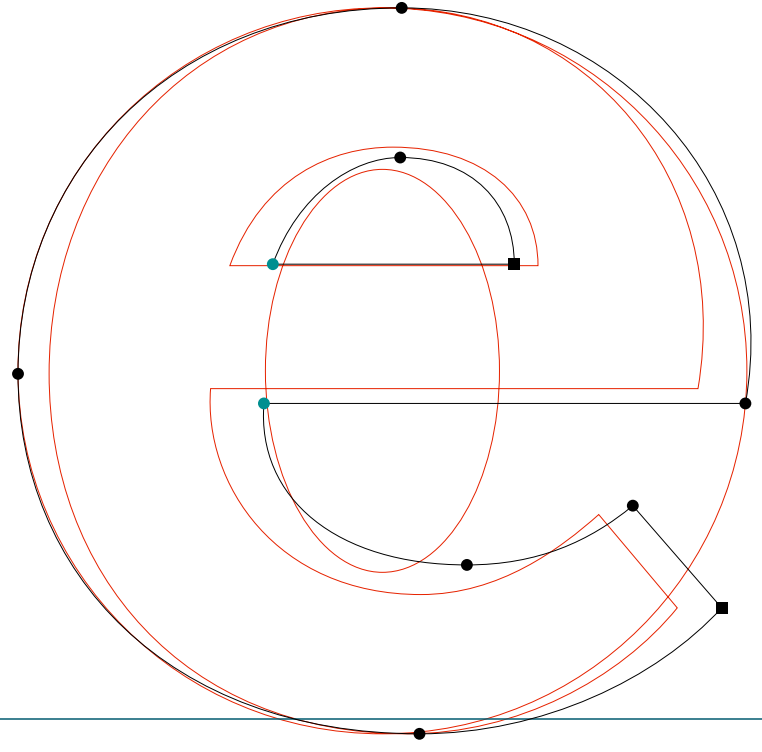
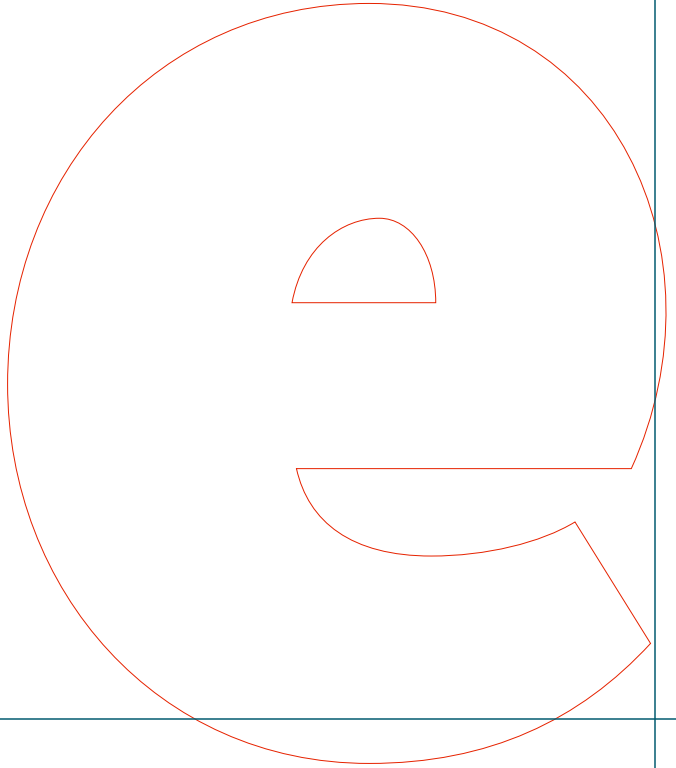



**BASE 9 & 12**

BaseNine B | g | RoboFog Sketches | 1995 | Emigre Fonts

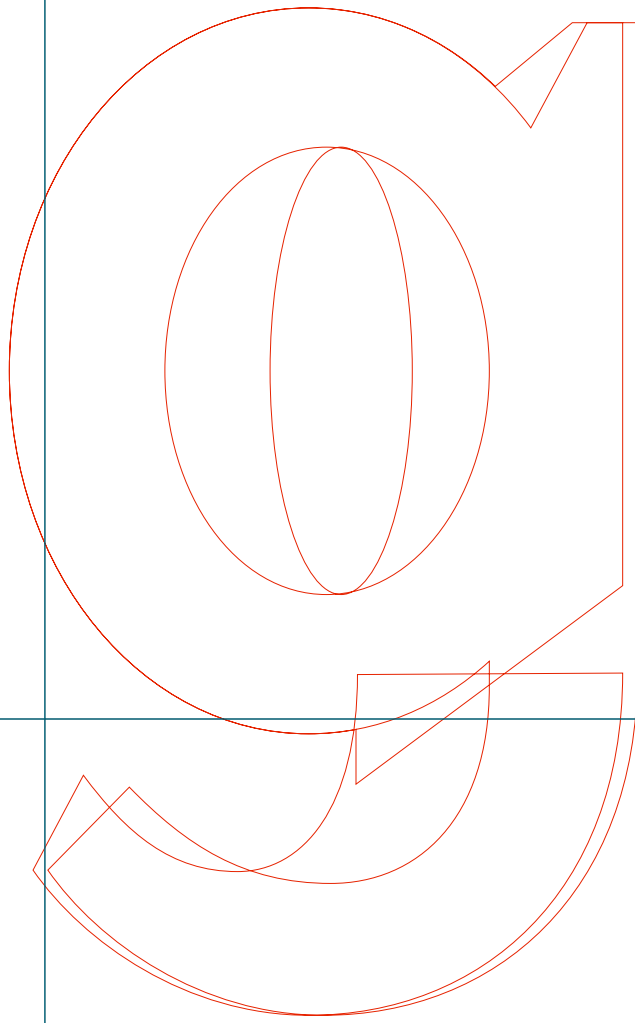
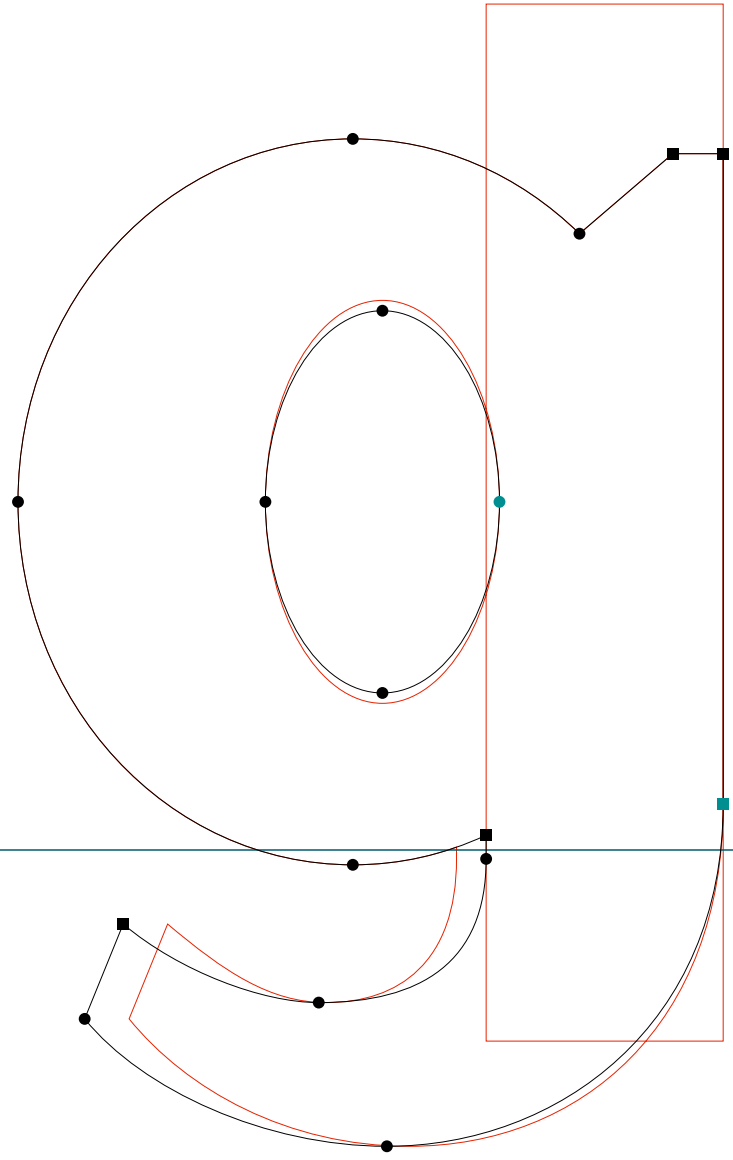

**BASE 9 & 12**

BaseNine B | j | RoboFog Sketches | 1995 | Emigre Fonts

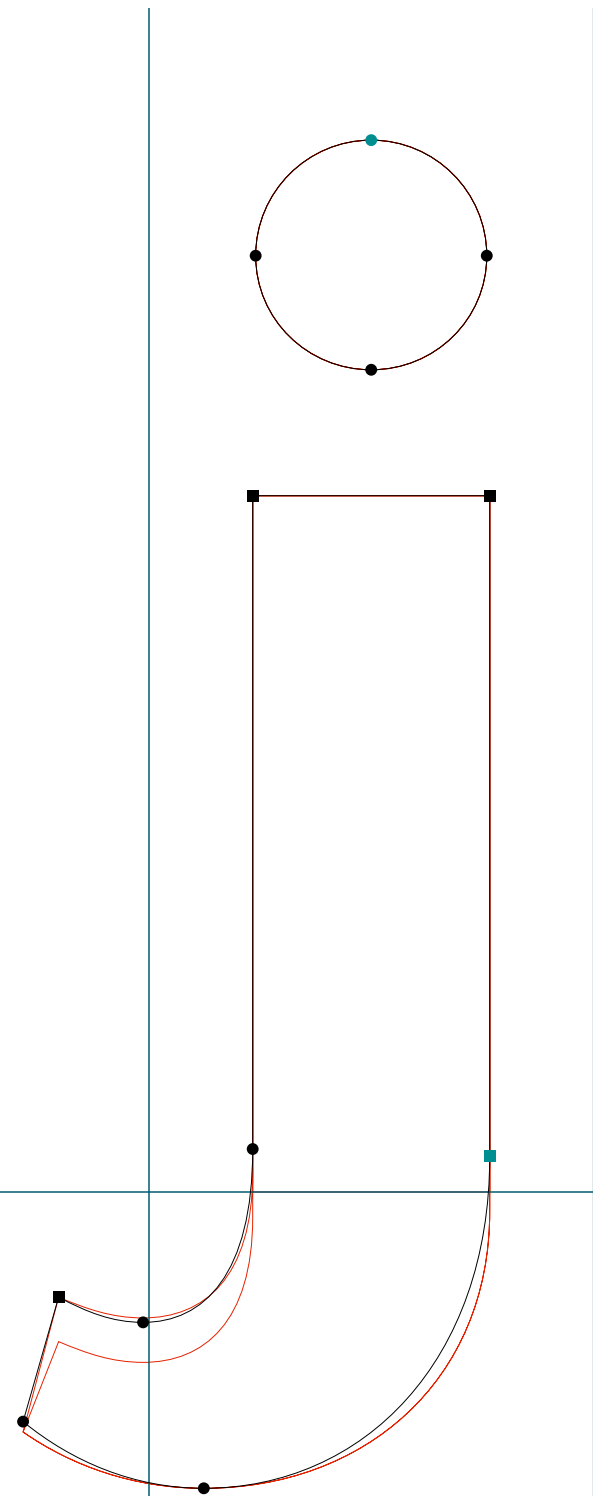

**BASE 9 & 12**

.....  
BaseNine B | m | RoboFog Sketches | 1995 | Emigre Fonts

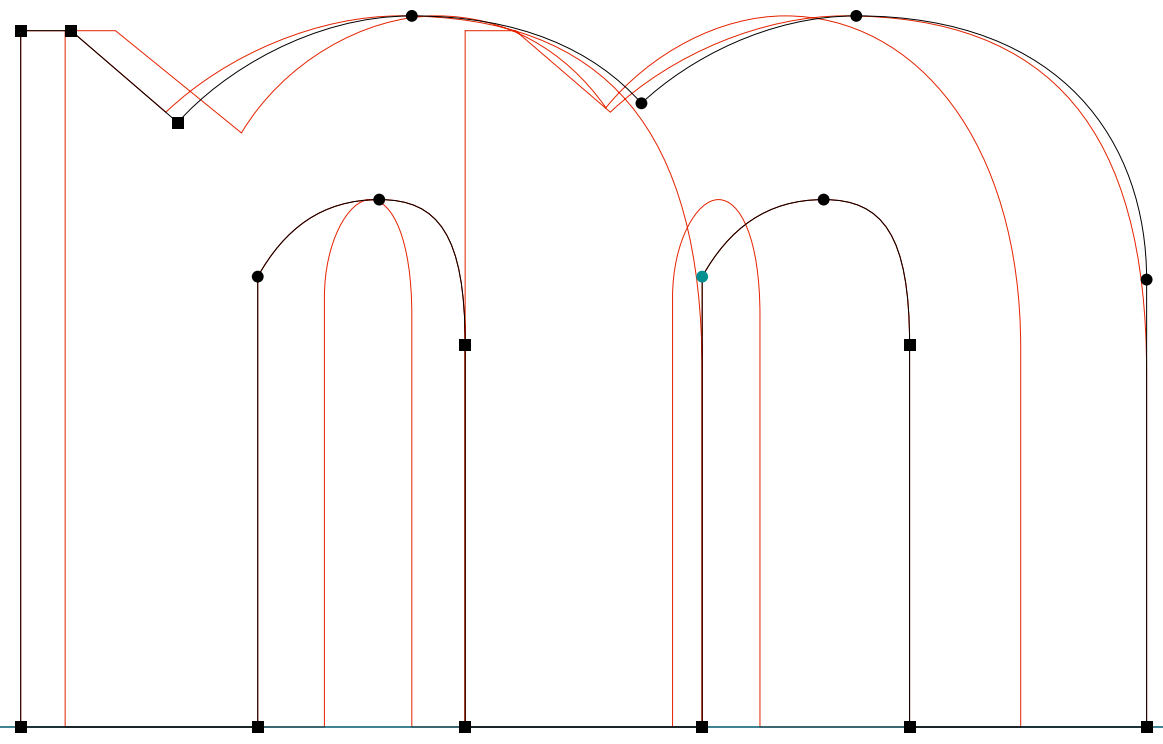

**BASE 9 & 12**

.....  
BaseNine B | o | RoboFog Sketches | 1995 | Emigre Fonts

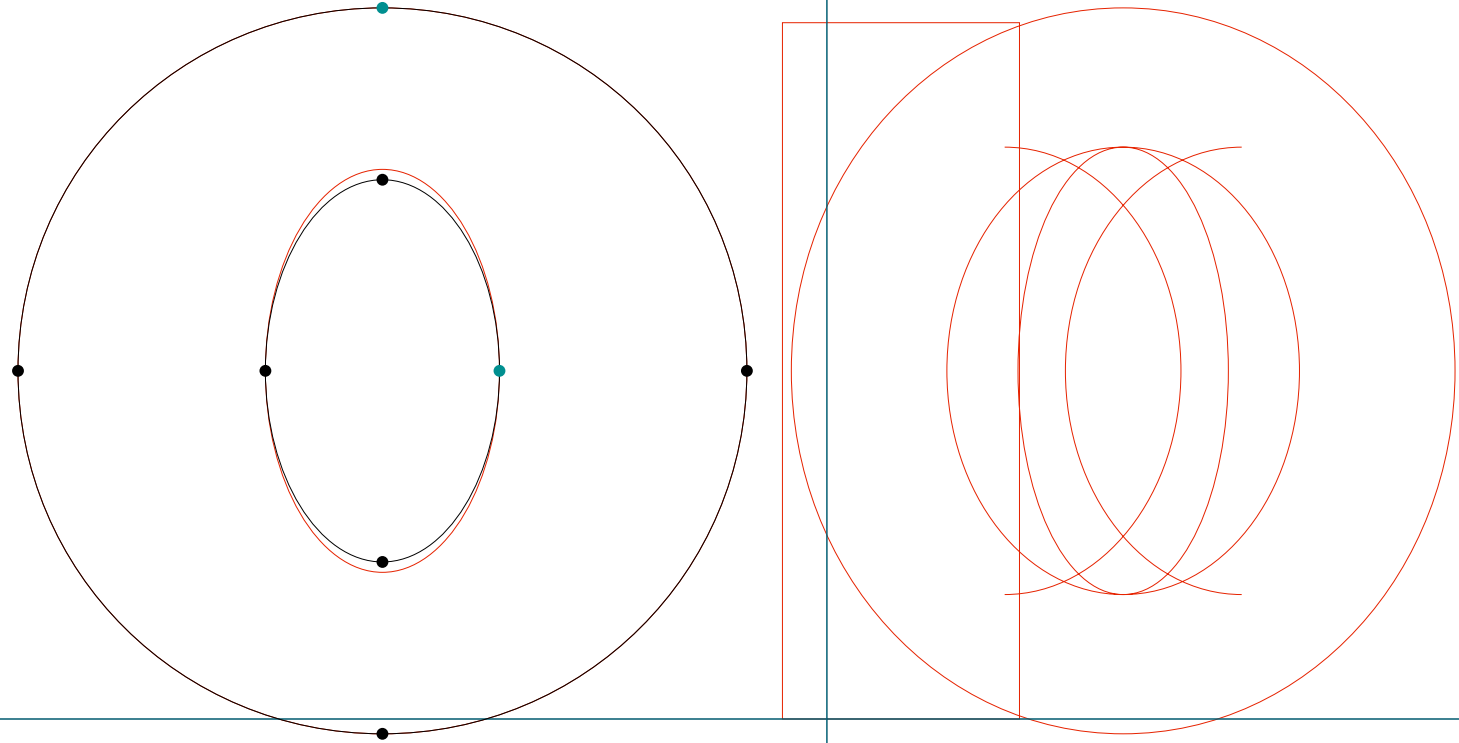

**BASE 9 & 12**

.....  
BaseNine B | r | RoboFog Sketches | 1995 | Emigre Fonts

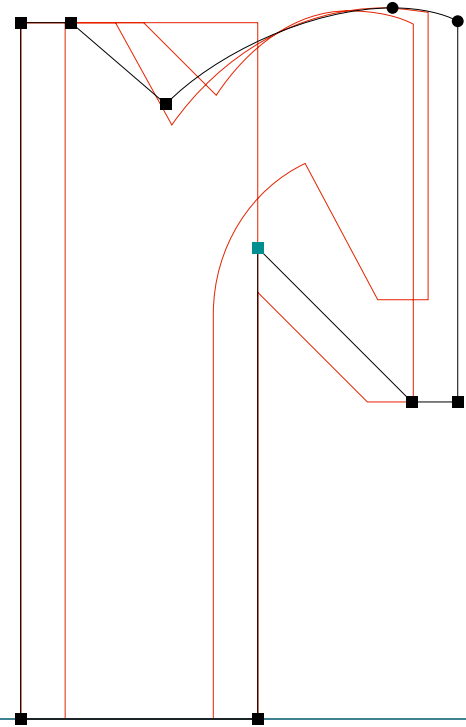
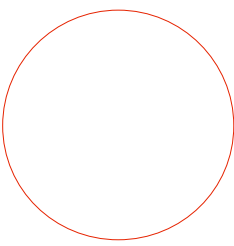

**BASE 9 & 12**

BaseNine B | s | RoboFog Sketches | 1995 | Emigre Fonts

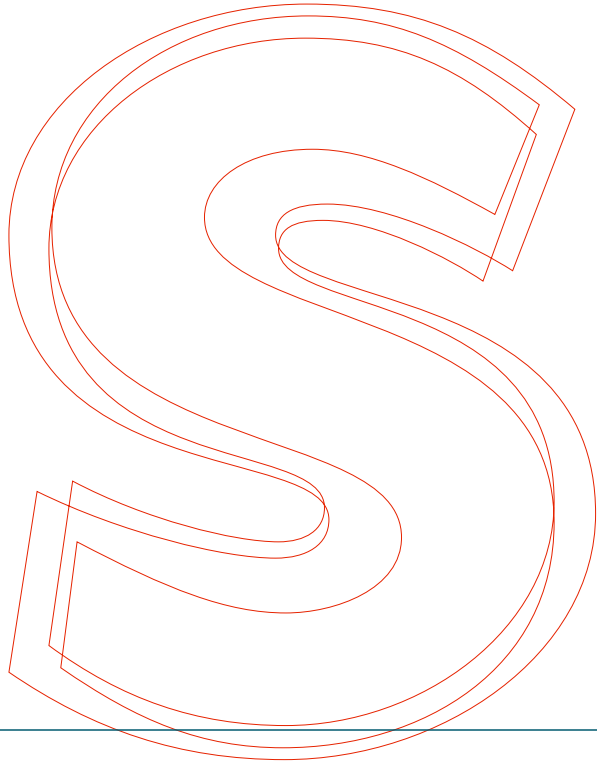
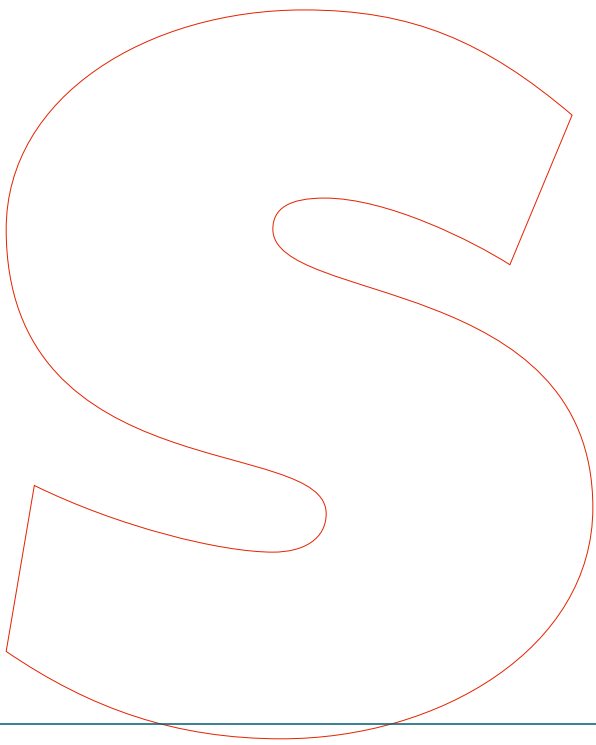
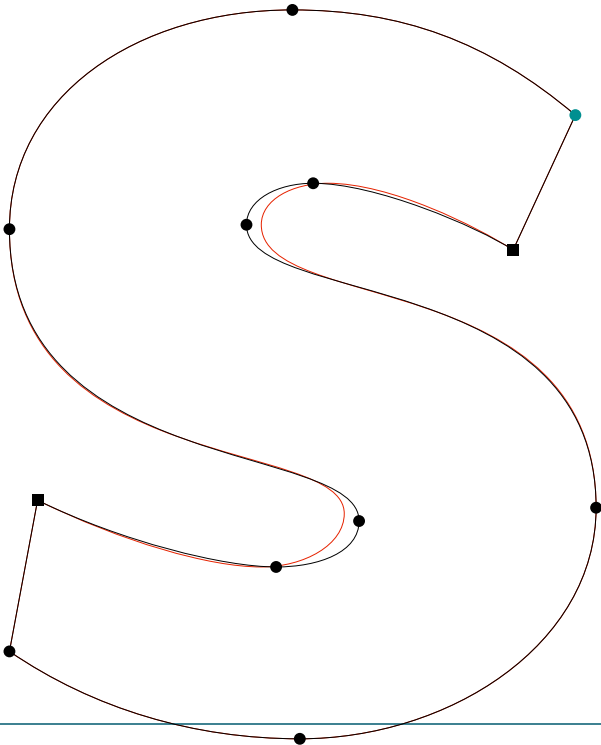

**BASE 9 & 12**

BaseNine B | u | RoboFog Sketches | 1995 | Emigre Fonts

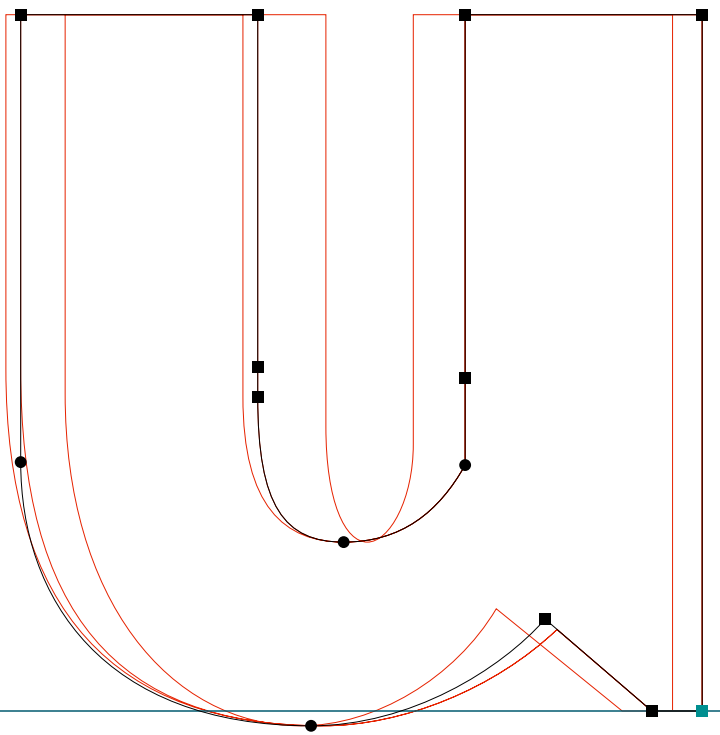

**BASE 9 & 12**

.....  
BaseNine B | y | RoboFog Sketches | 1995 | Emigre Fonts

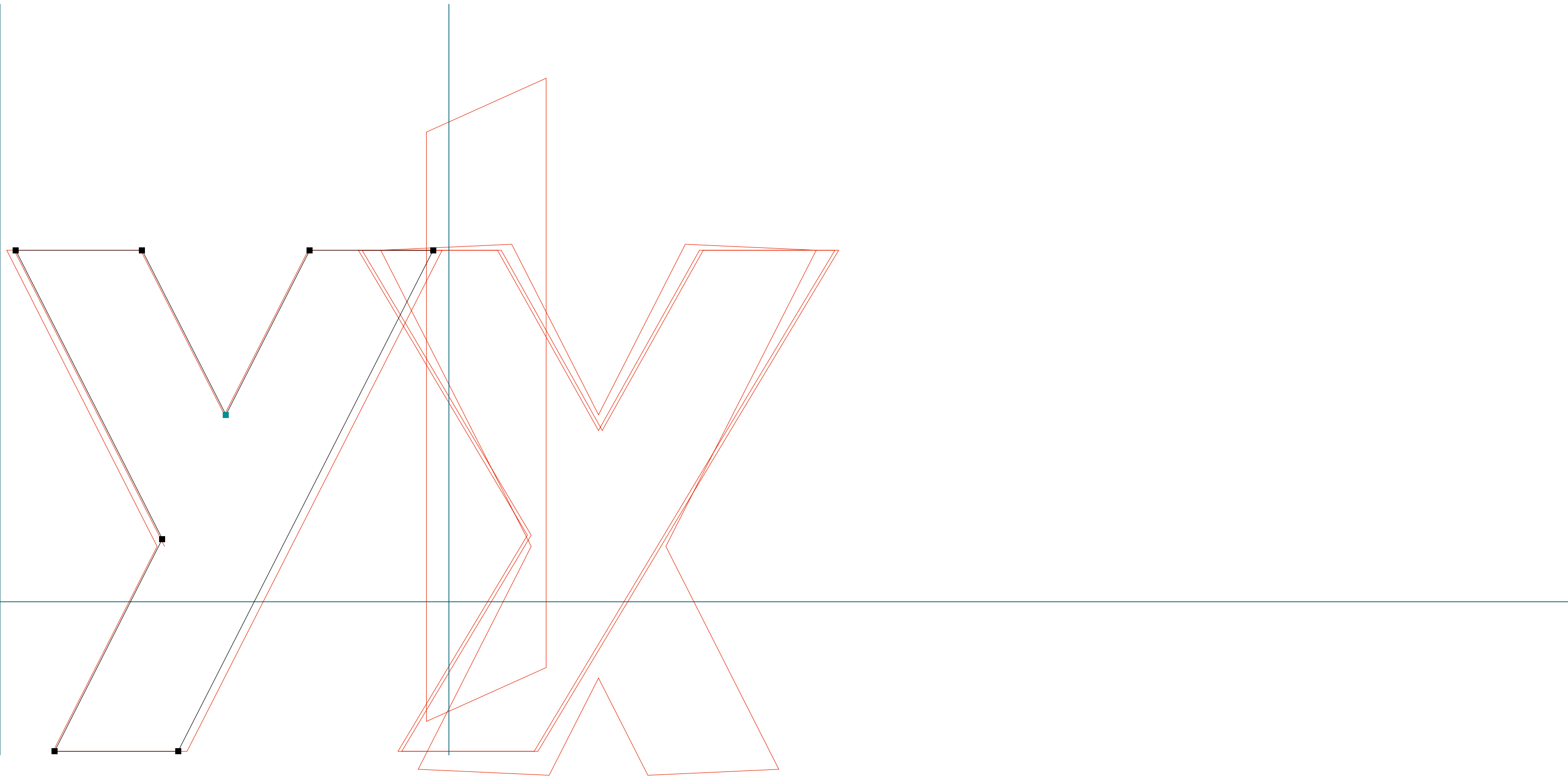



**BASE 9 & 12**

.....  
BaseNine B | asciitilde | RoboFog Sketches | 1995 | Emigre Fonts

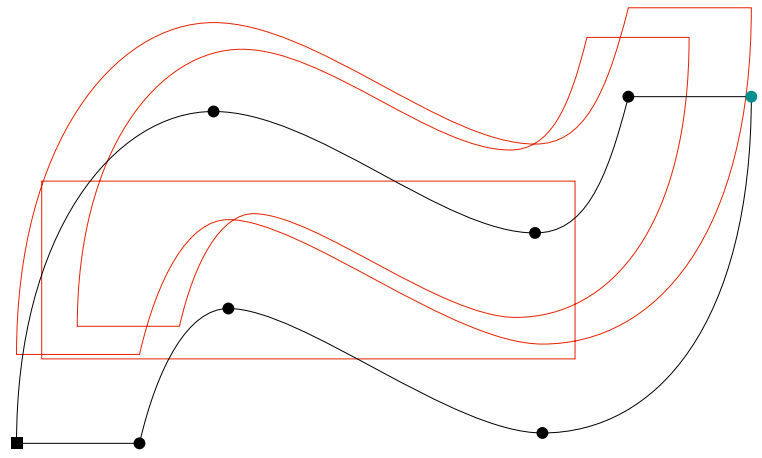

**BASE 9 & 12**

BaseNine SCB | three | RoboFog Sketches | 1995 | Emigre Fonts

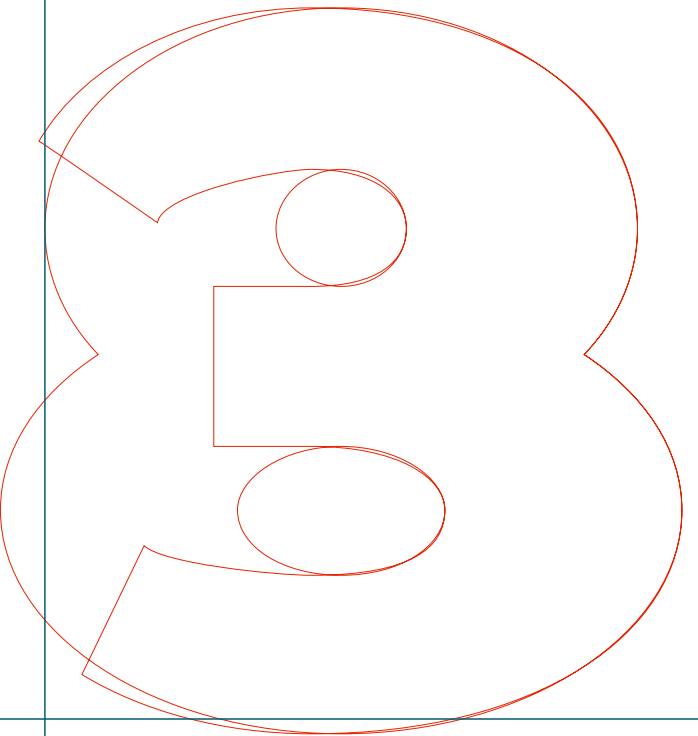
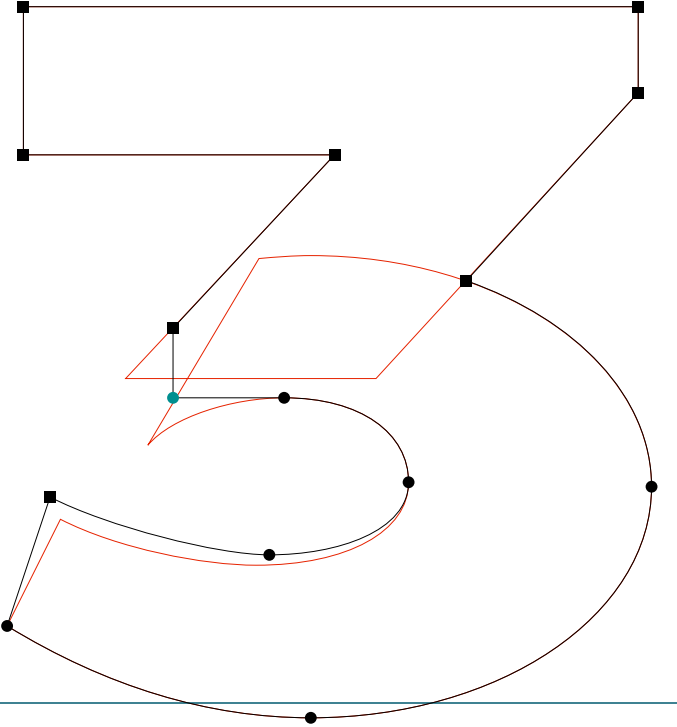

**BASE 9 & 12**

BaseNine SCB | five | RoboFog Sketches | 1995 | Emigre Fonts

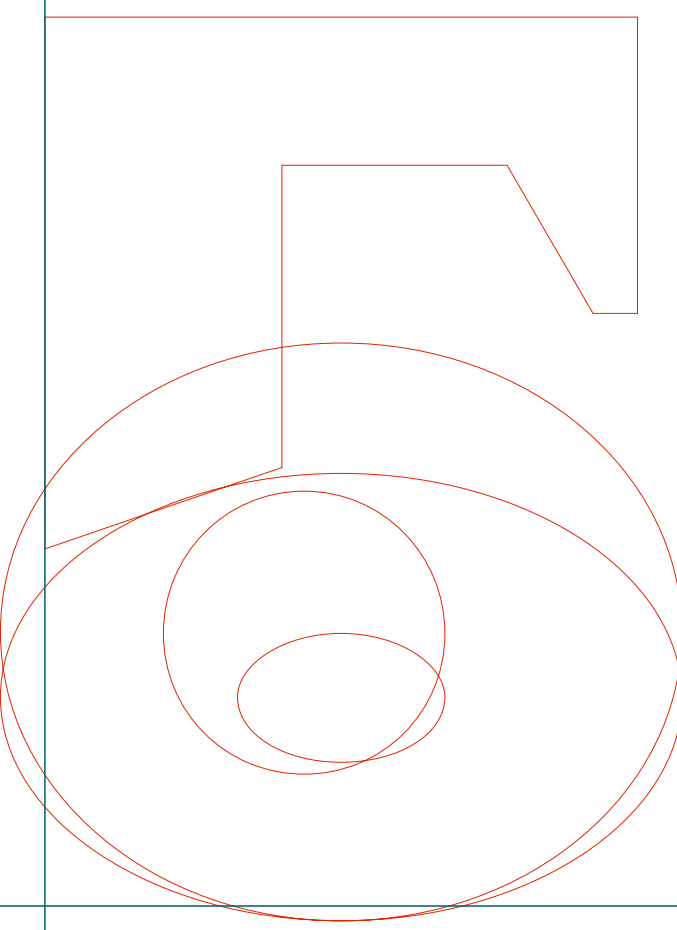
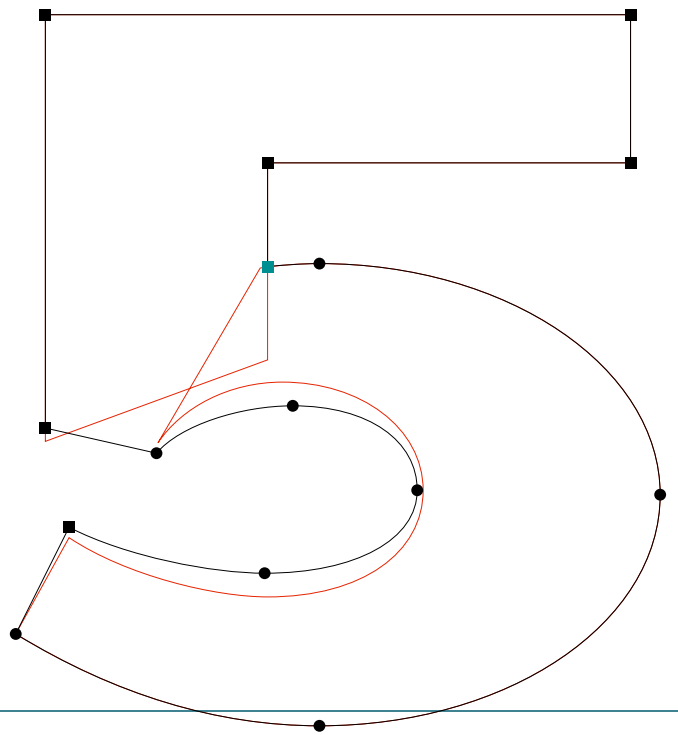

**BASE 9 & 12**

.....  
BaseNine SCB | eight | RoboFog Sketches | 1995 | Emigre Fonts

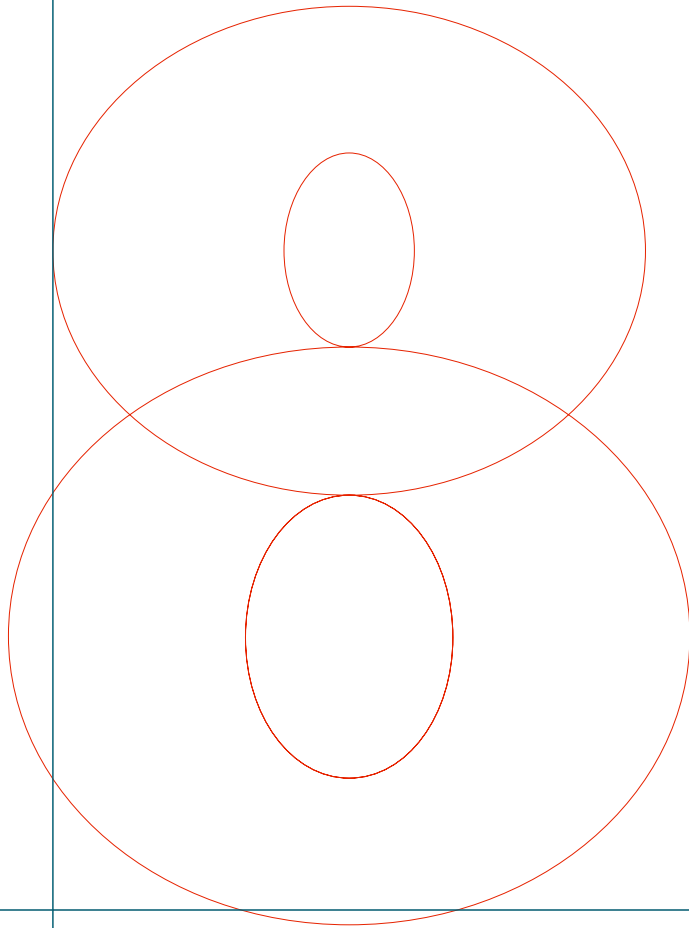
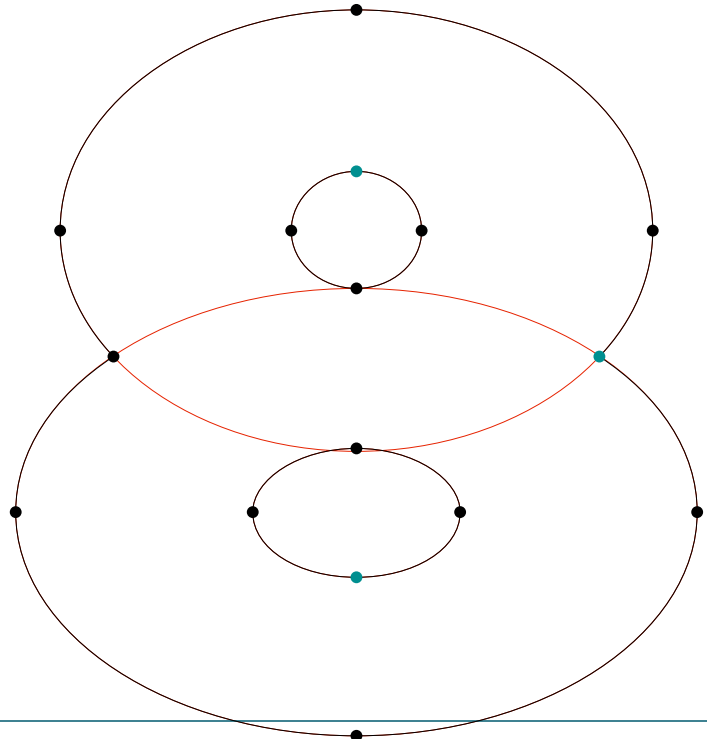
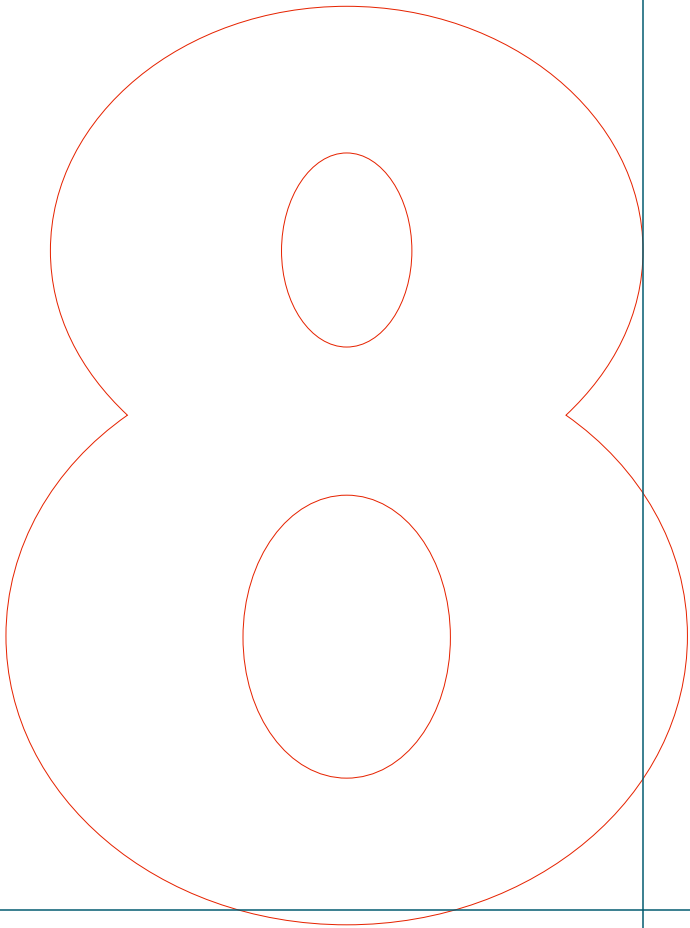

**BASE 9 & 12**

.....  
BaseNine SCB | J | RoboFog Sketches | 1995 | Emigre Fonts

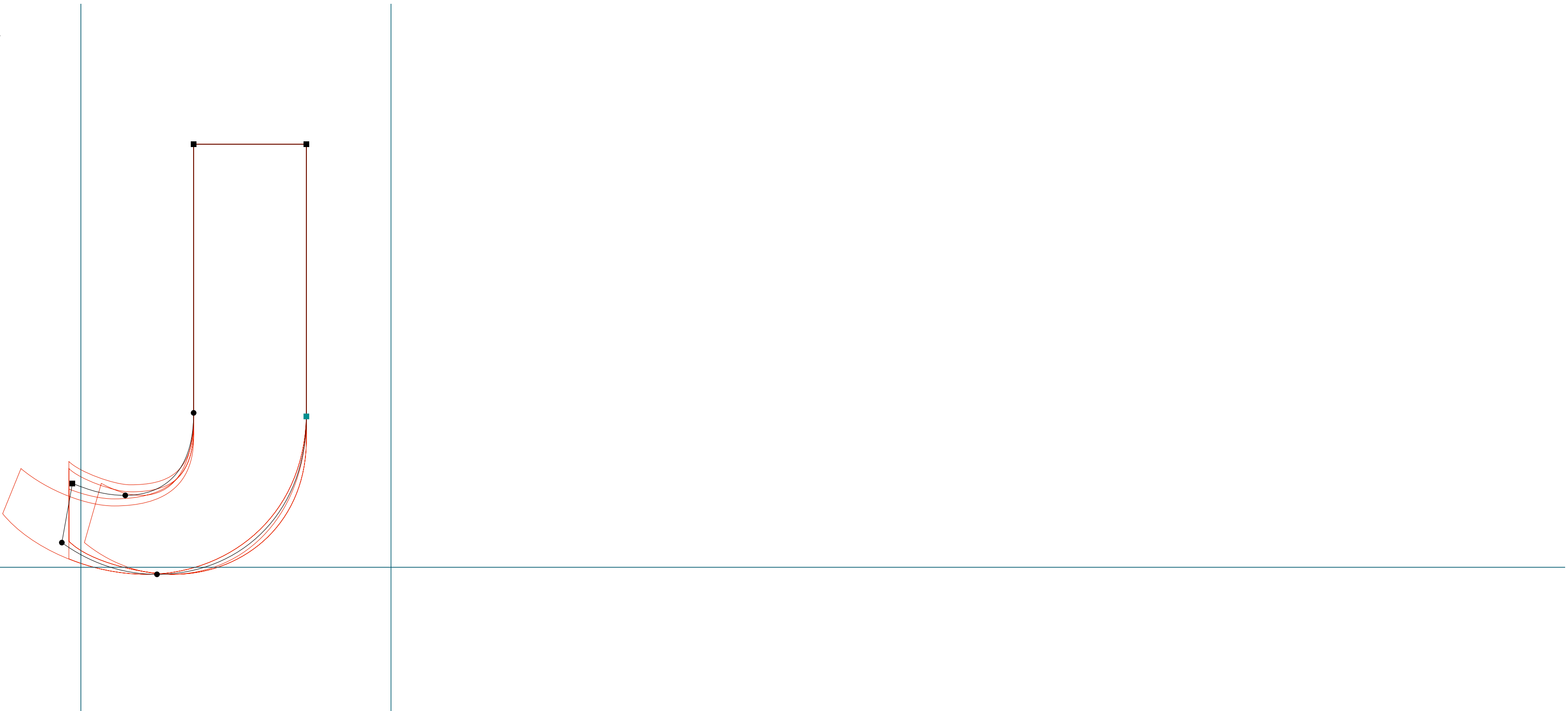

**BASE 9 & 12**

.....  
BaseNine SCB | L | RoboFog Sketches | 1995 | Emigre Fonts

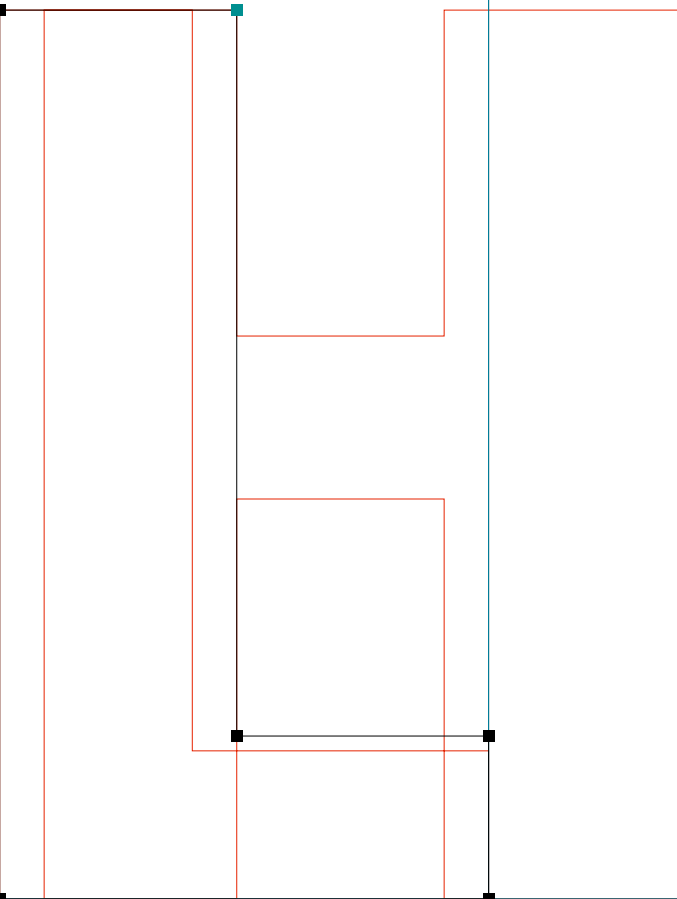

**BASE 9 & 12**

.....  
BaseNine SCB | M | RoboFog Sketches | 1995 | Emigre Fonts

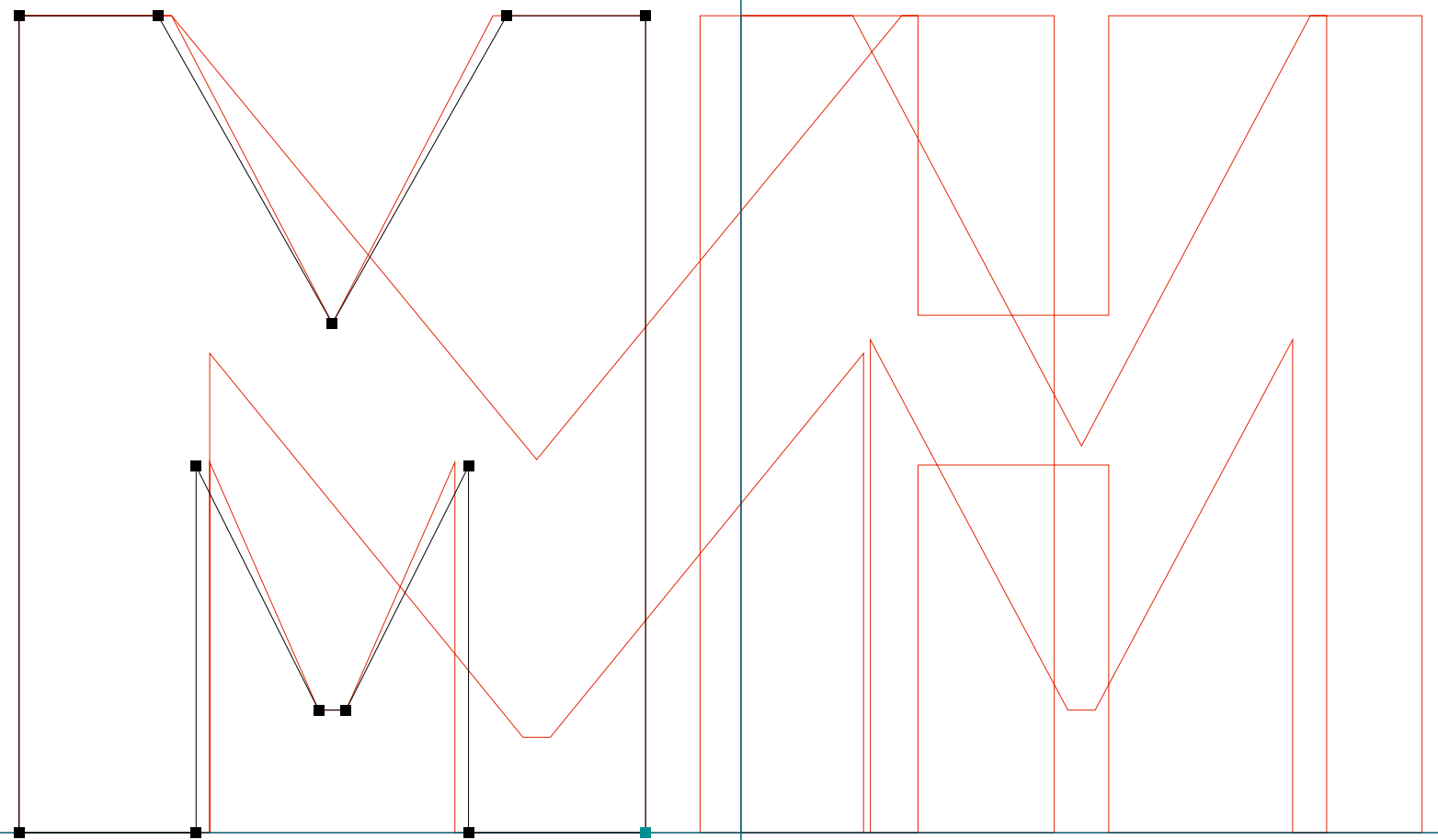

**BASE 9 & 12**

.....  
BaseNine SCB | N | RoboFog Sketches | 1995 | Emigre Fonts

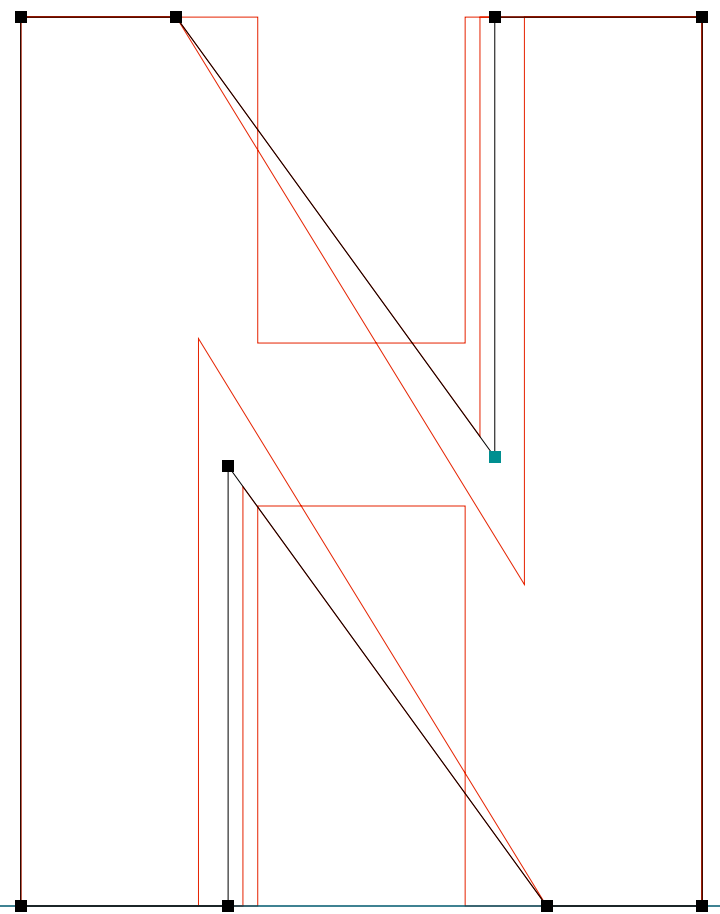



**BASE 9 & 12**

.....  
BaseNine SCB | Q | RoboFog Sketches | 1995 | Emigre Fonts

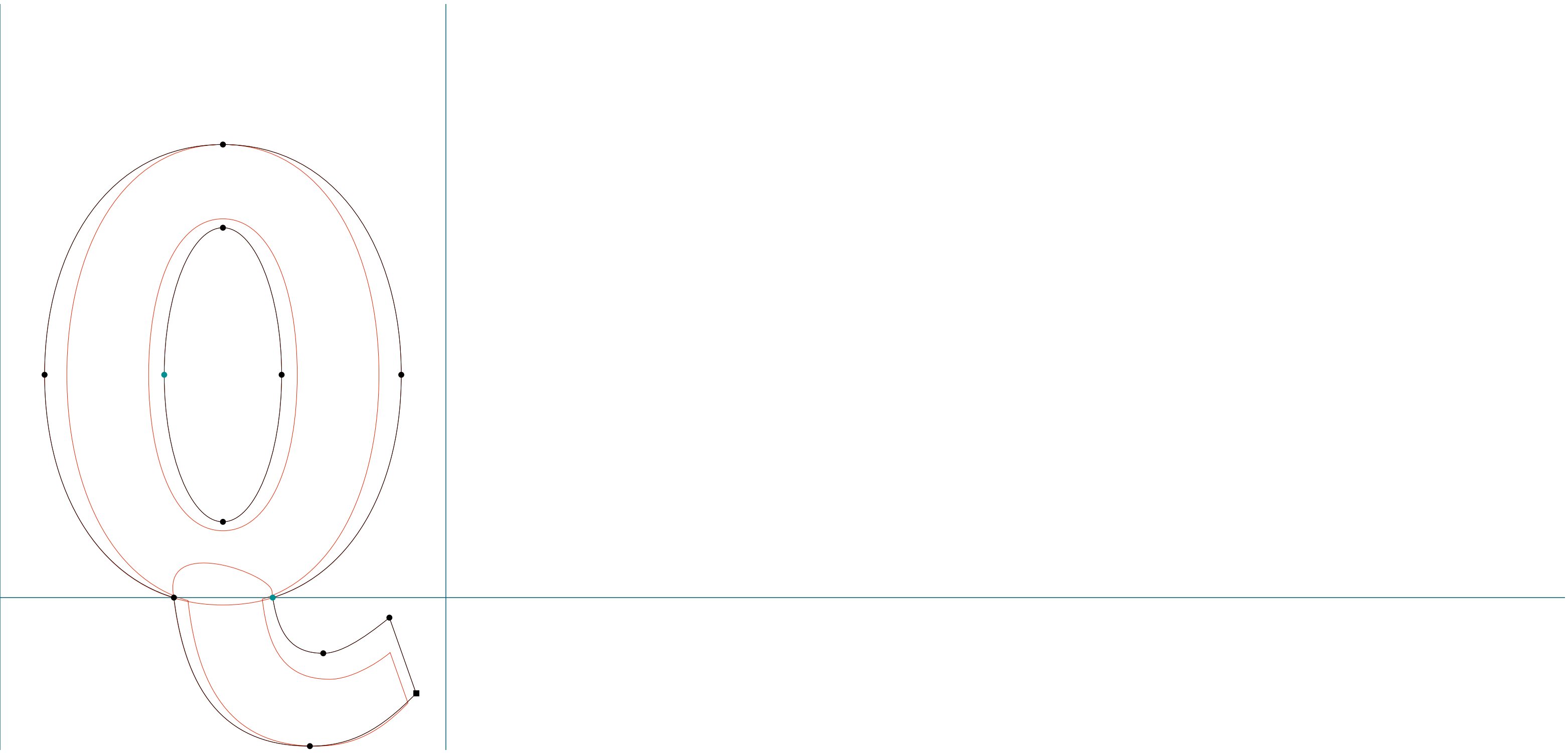

**BASE 9 & 12**

.....  
BaseNine SCB | V | RoboFog Sketches | 1995 | Emigre Fonts

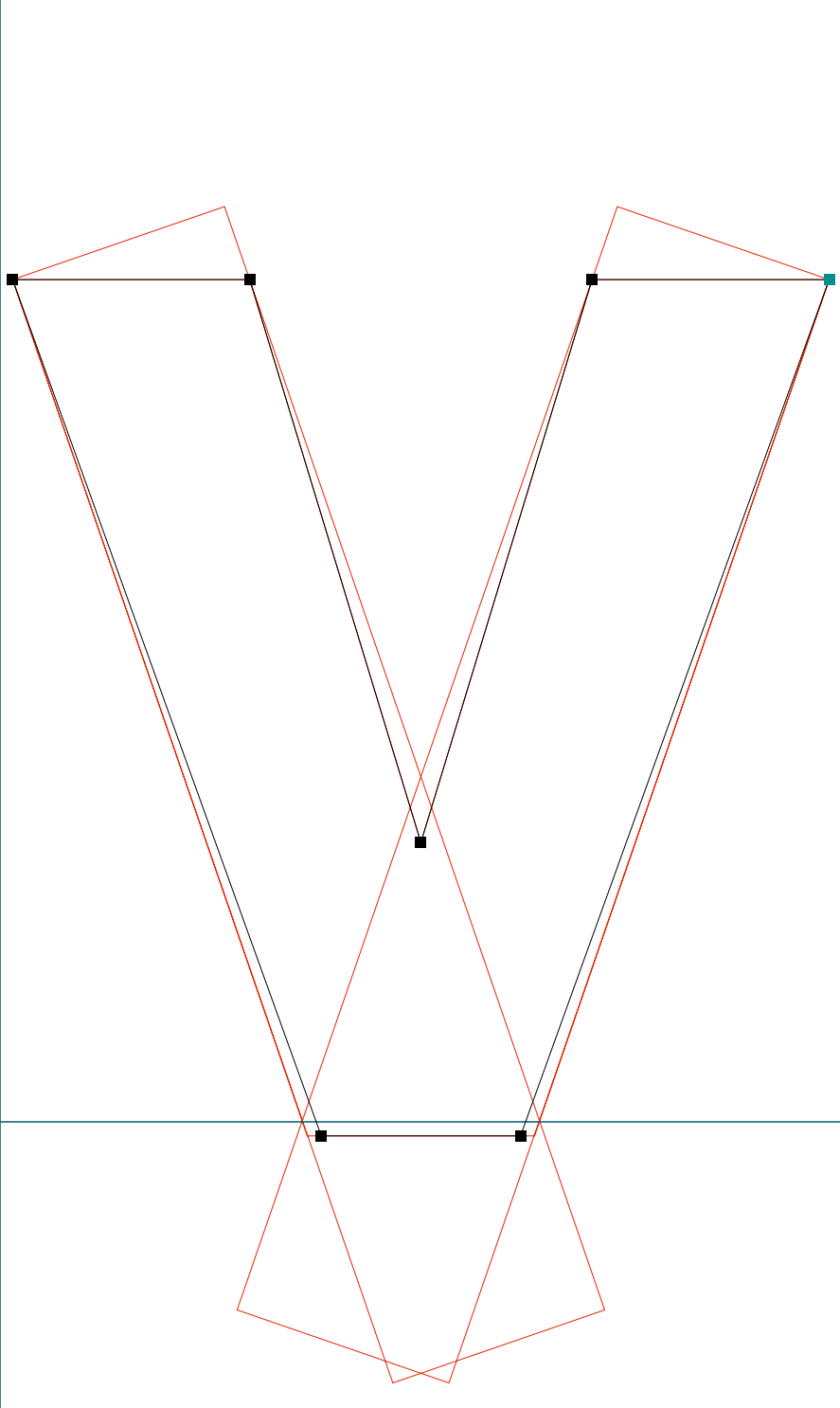

**BASE 9 & 12**

BaseNine BI | one | RoboFog Sketches | 1995 | Emigre Fonts

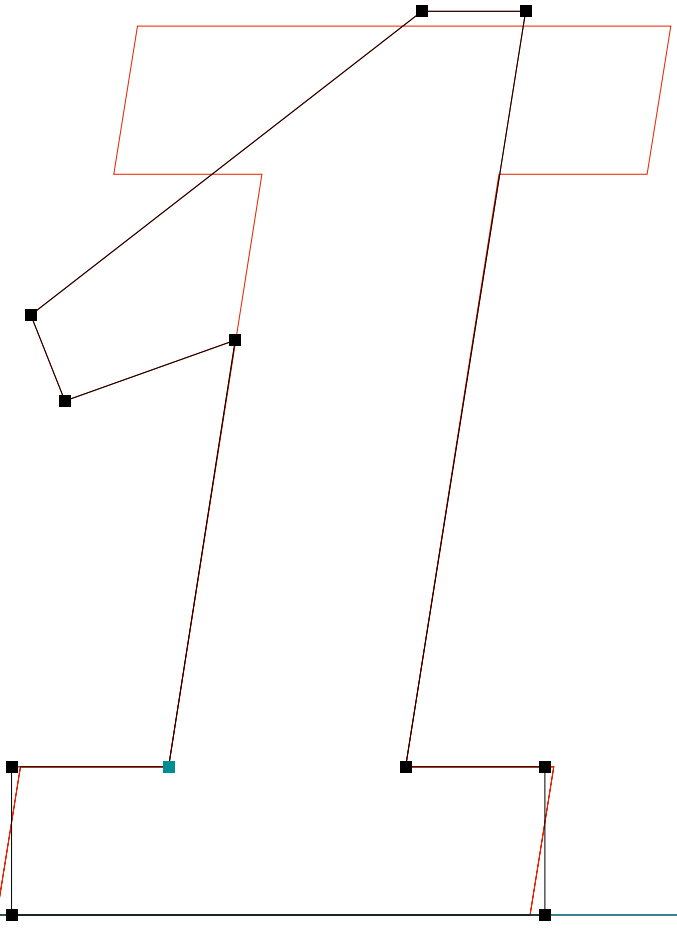

**BASE 9 & 12**

.....  
BaseNine SCBI | a | RoboFog Sketches | 1995 | Emigre Fonts

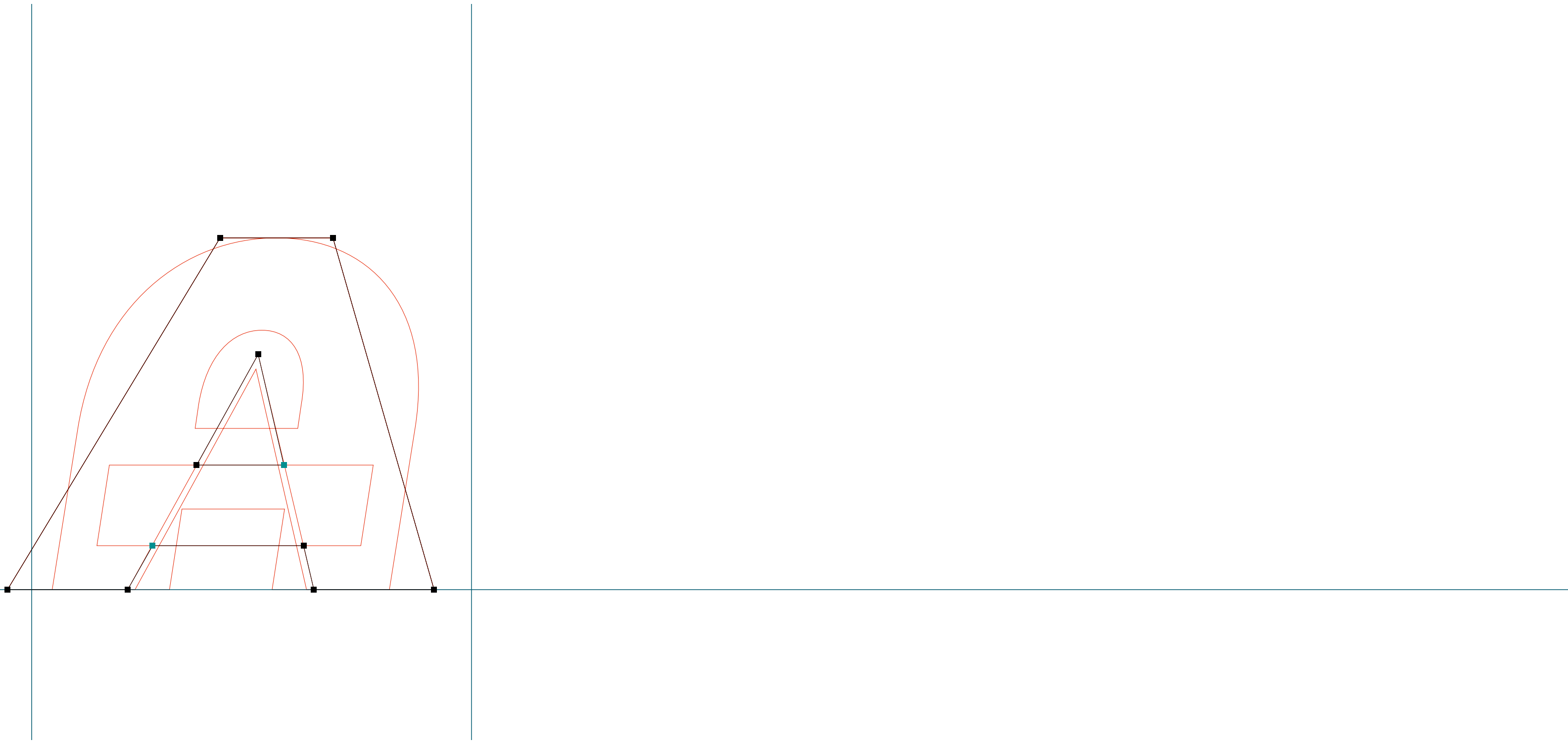

**BASE 9 & 12**

.....  
BaseTwelve Sans | eth | RoboFog Sketches | 1995 | Emigre Fonts

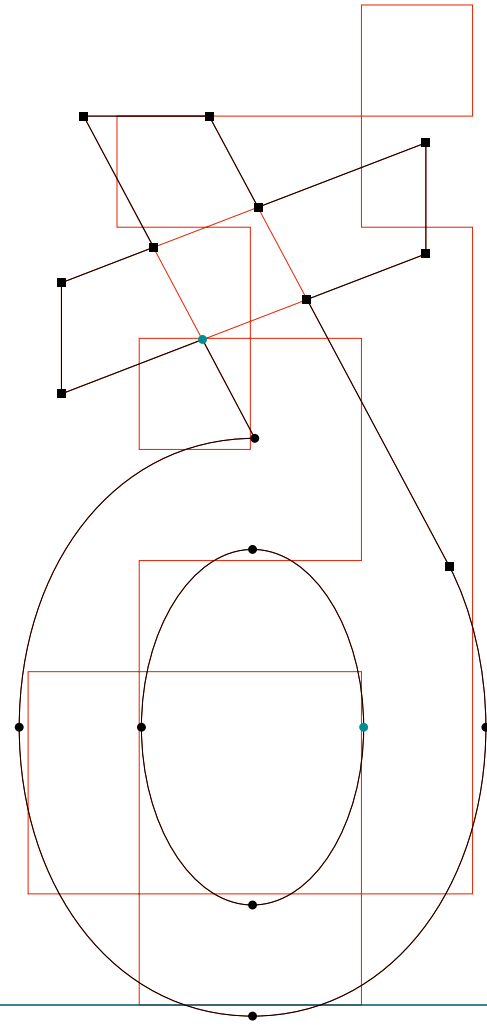

**BASE 9 & 12**

.....  
BaseTwelve Sans | dollar | RoboFog Sketches | 1995 | Emigre Fonts

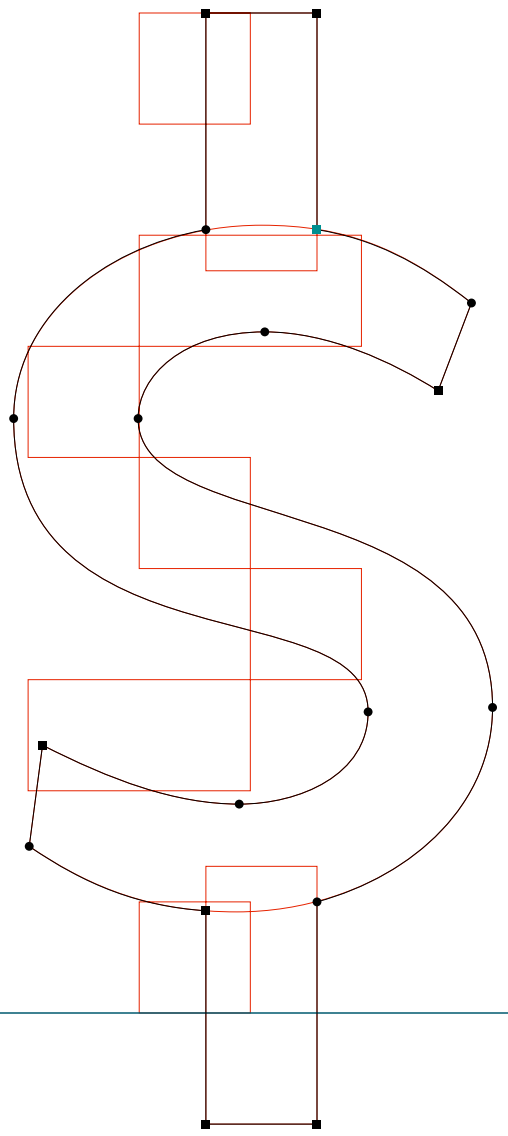

**BASE 9 & 12**

.....  
BaseTwelve Sans | percent | RoboFog Sketches | 1995 | Emigre Fonts

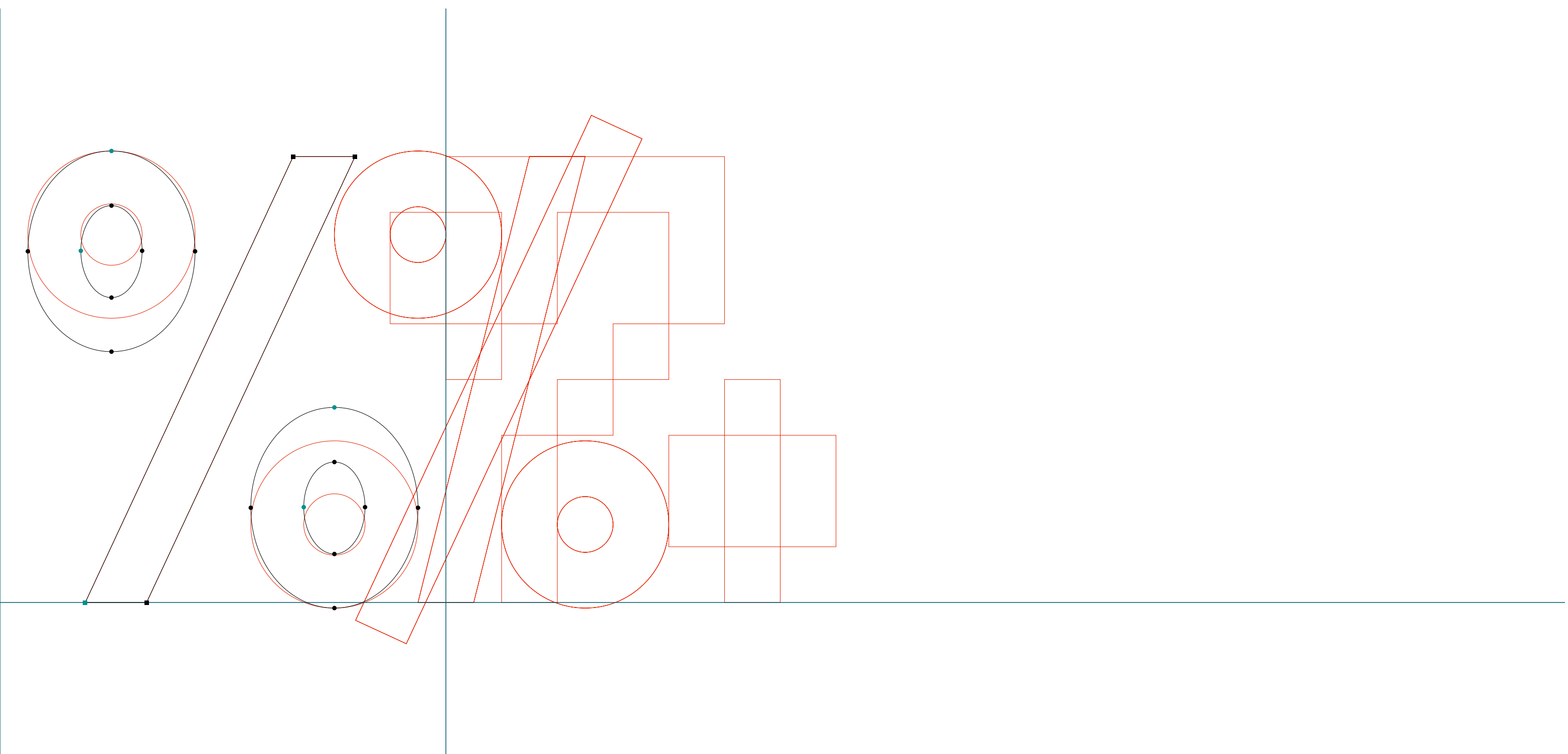

**BASE 9 & 12**

.....  
BaseTwelve Sans | ampersand | RoboFog Sketches | 1995 | Emigre Fonts

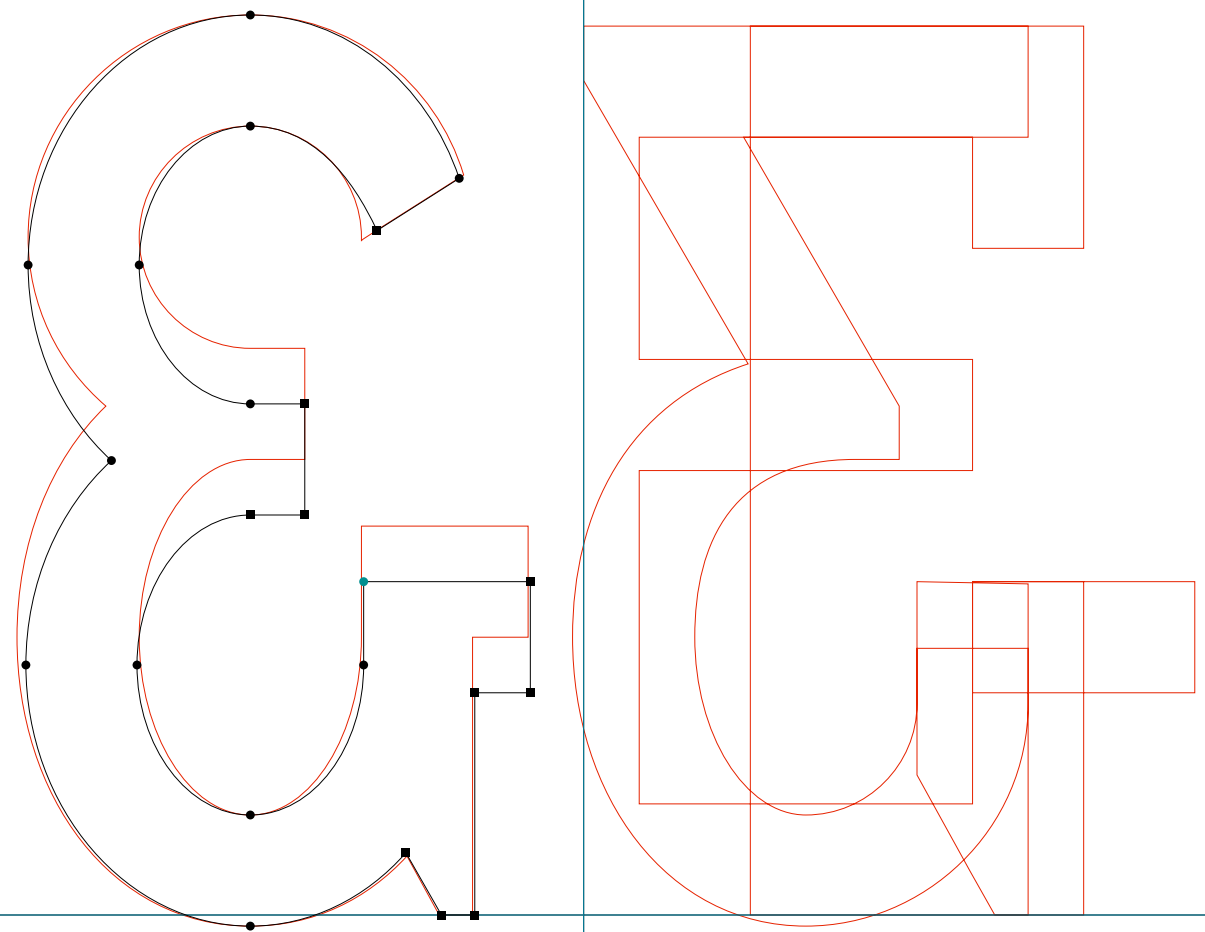



**BASE 9 & 12**

.....  
BaseTwelve Sans | asterisk | RoboFog Sketches | 1995 | Emigre Fonts

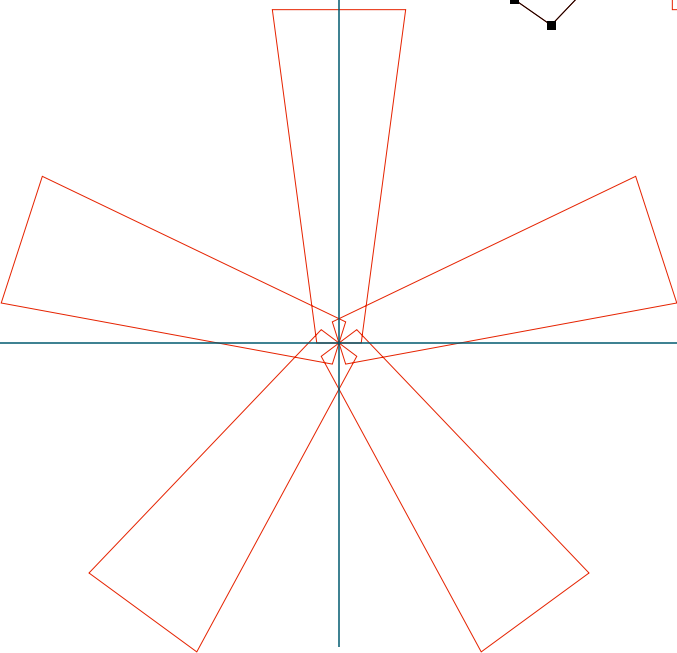
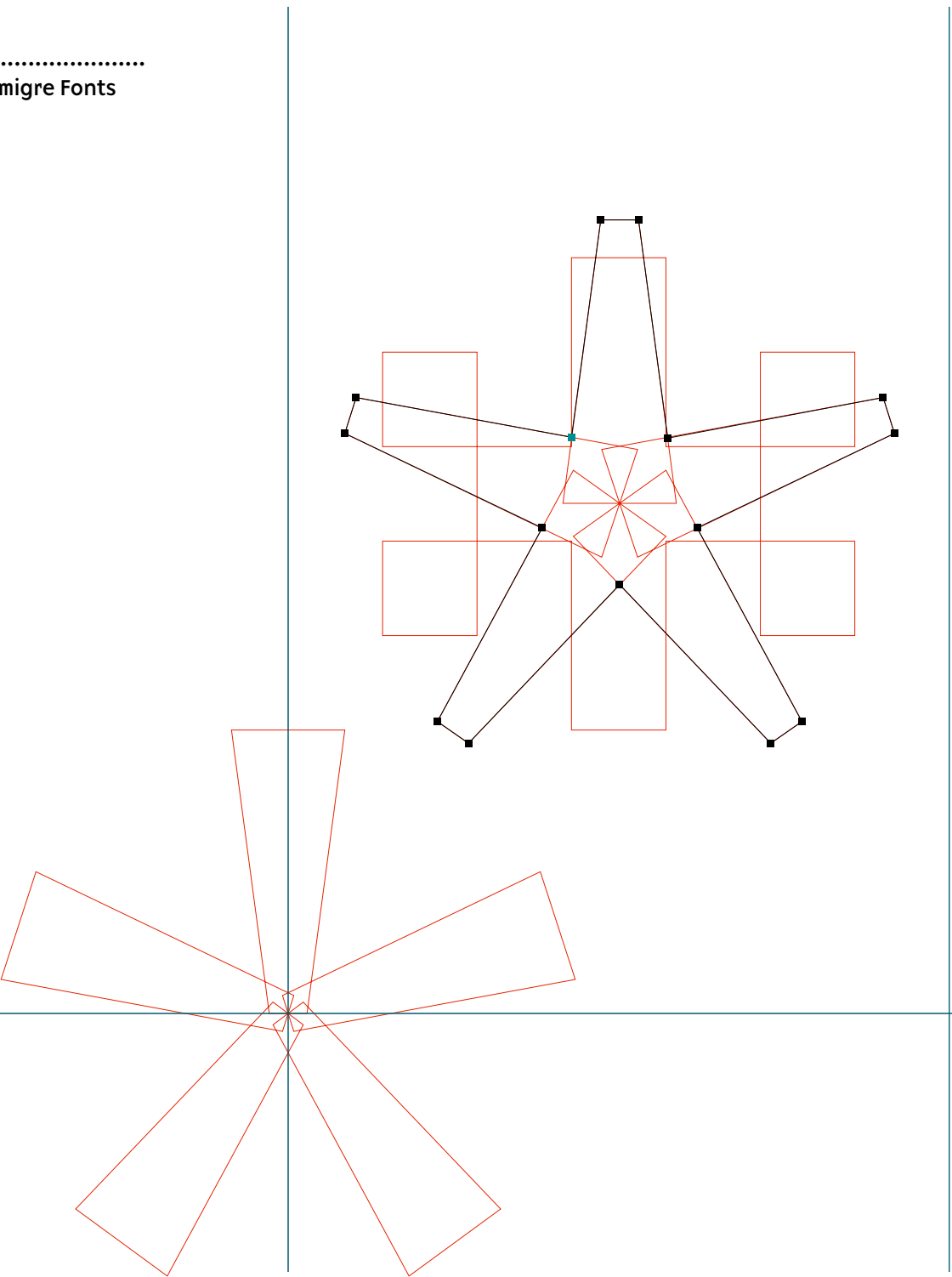

**BASE 9 & 12**

BaseTwelve Sans | comma | RoboFog Sketches | 1995 | Emigre Fonts

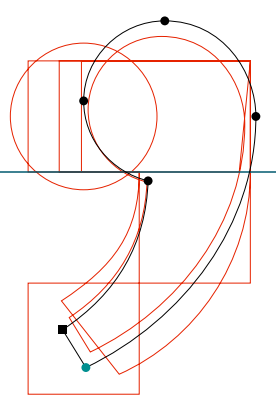

**BASE 9 & 12**

BaseTwelve Sans | period | RoboFog Sketches | 1995 | Emigre Fonts

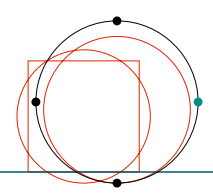

**BASE 9 & 12**

.....  
BaseTwelve Sans | slash | RoboFog Sketches | 1995 | Emigre Fonts

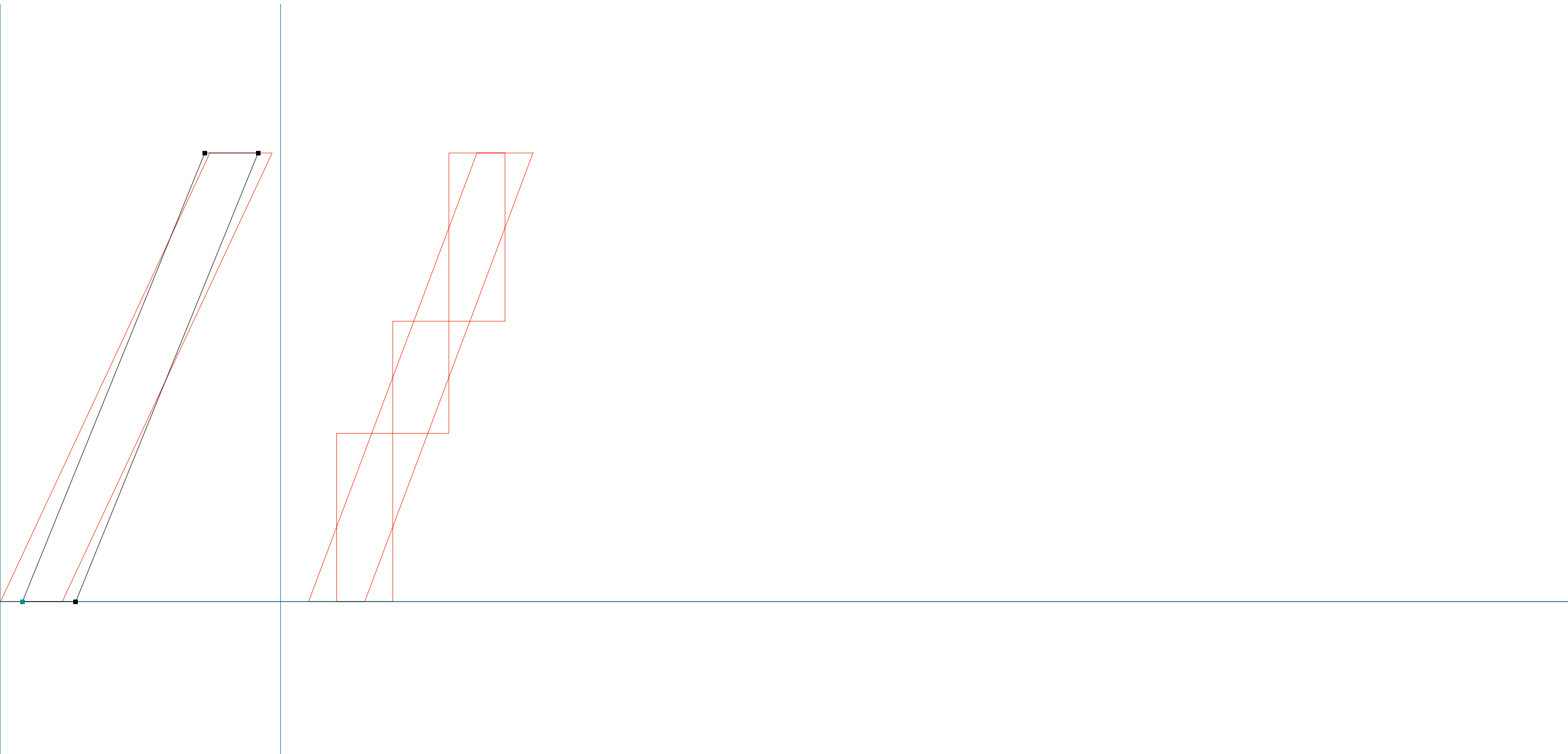

**BASE 9 & 12**

.....  
BaseTwelve Sans | two | RoboFog Sketches | 1995 | Emigre Fonts

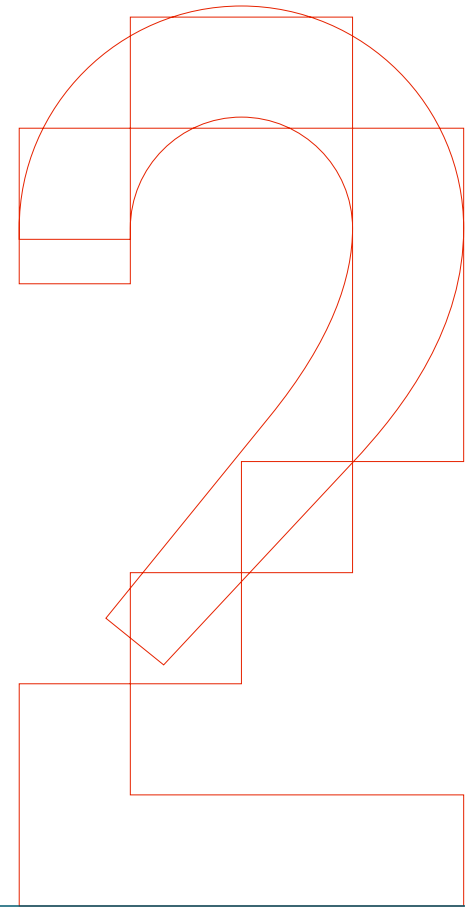
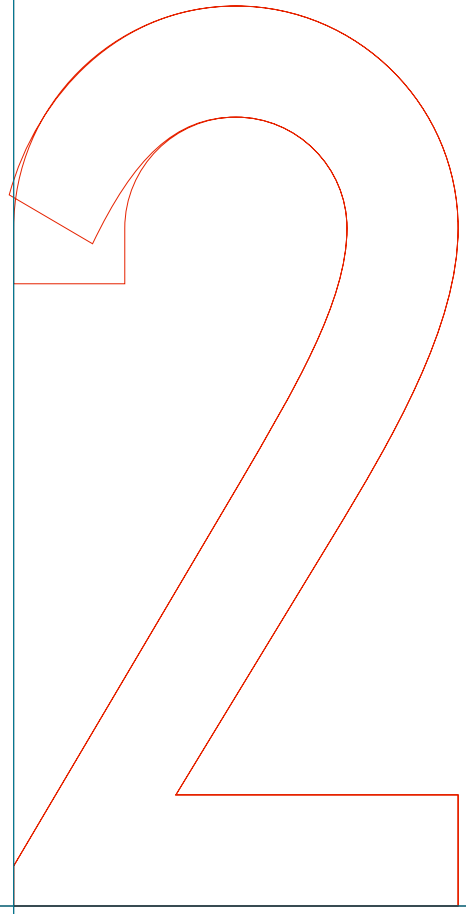
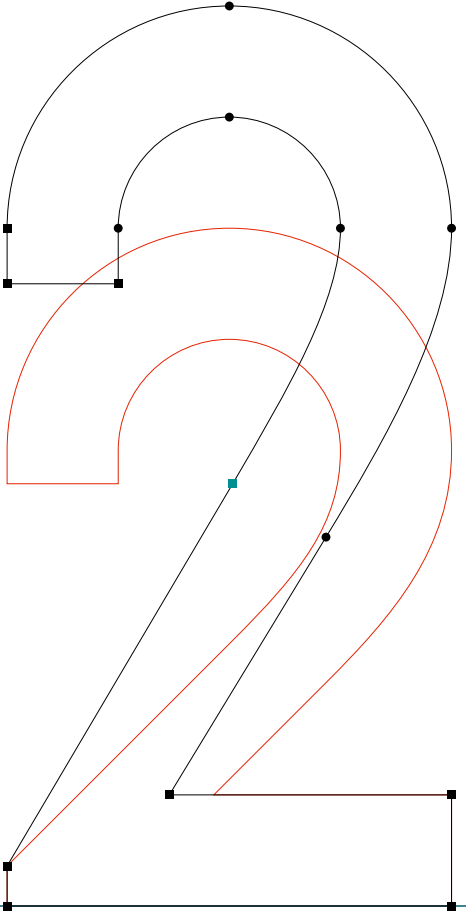

**BASE 9 & 12**

.....  
BaseTwelve Sans | three | RoboFog Sketches | 1995 | Emigre Fonts

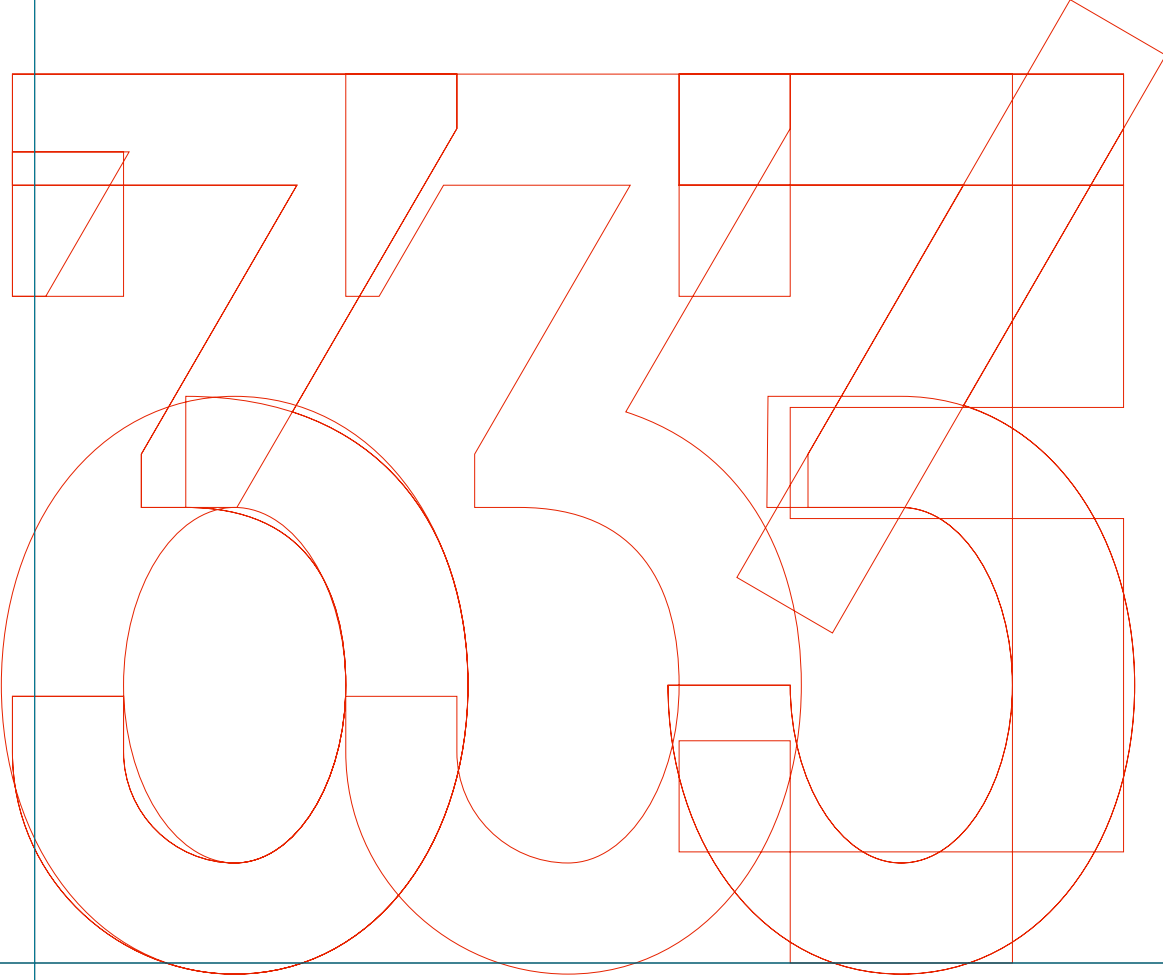
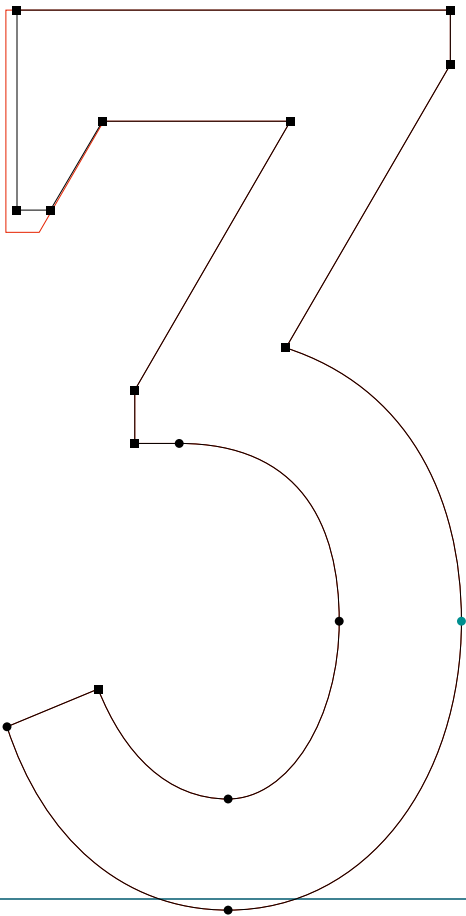

**BASE 9 & 12**

.....  
BaseTwelve Sans | four | RoboFog Sketches | 1995 | Emigre Fonts

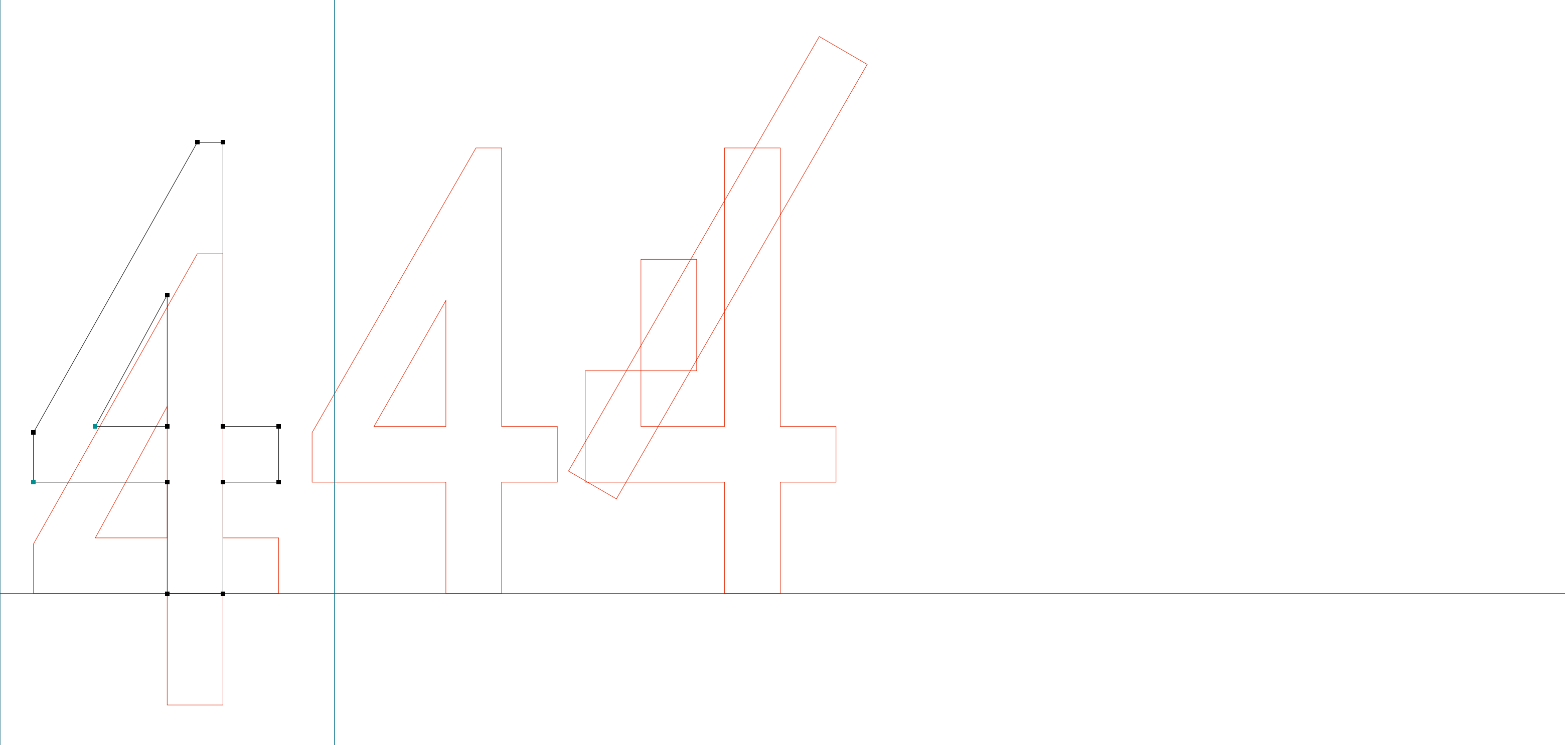

**BASE 9 & 12**

.....  
BaseTwelve Sans | five | RoboFog Sketches | 1995 | Emigre Fonts

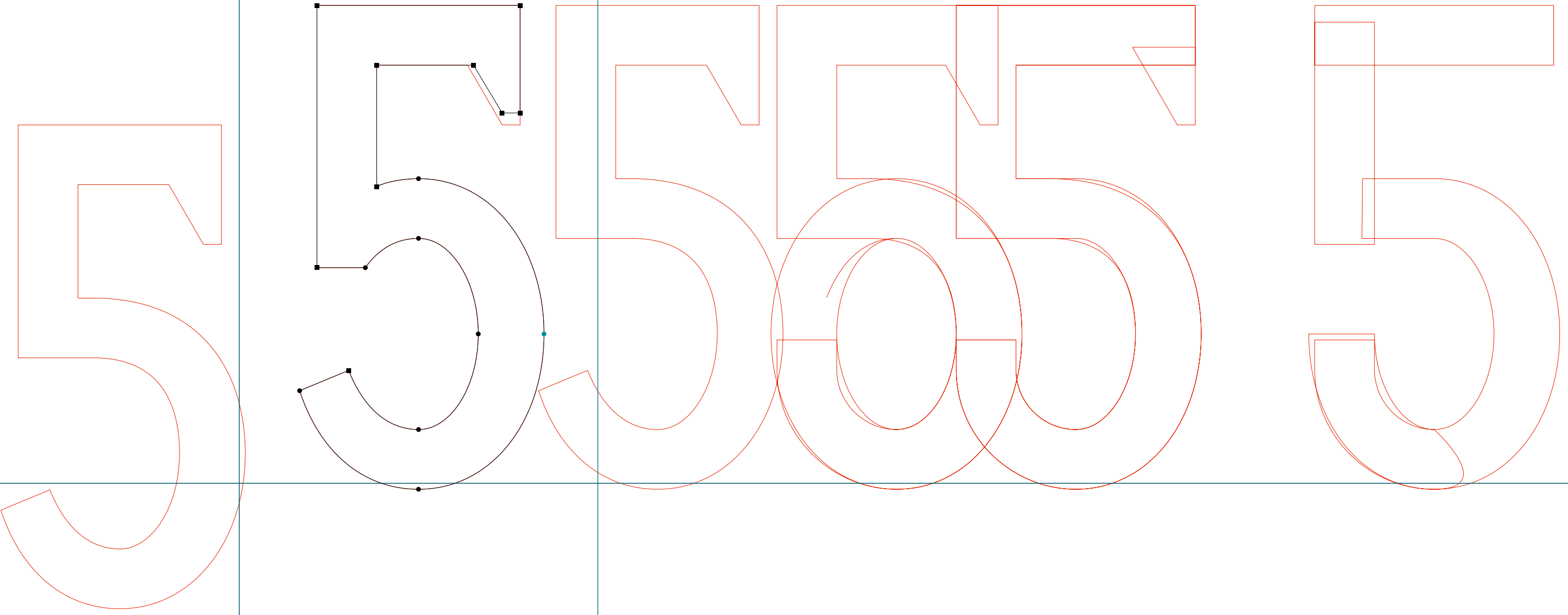



**BASE 9 & 12**

.....  
BaseTwelve Sans | six | RoboFog Sketches | 1995 | Emigre Fonts

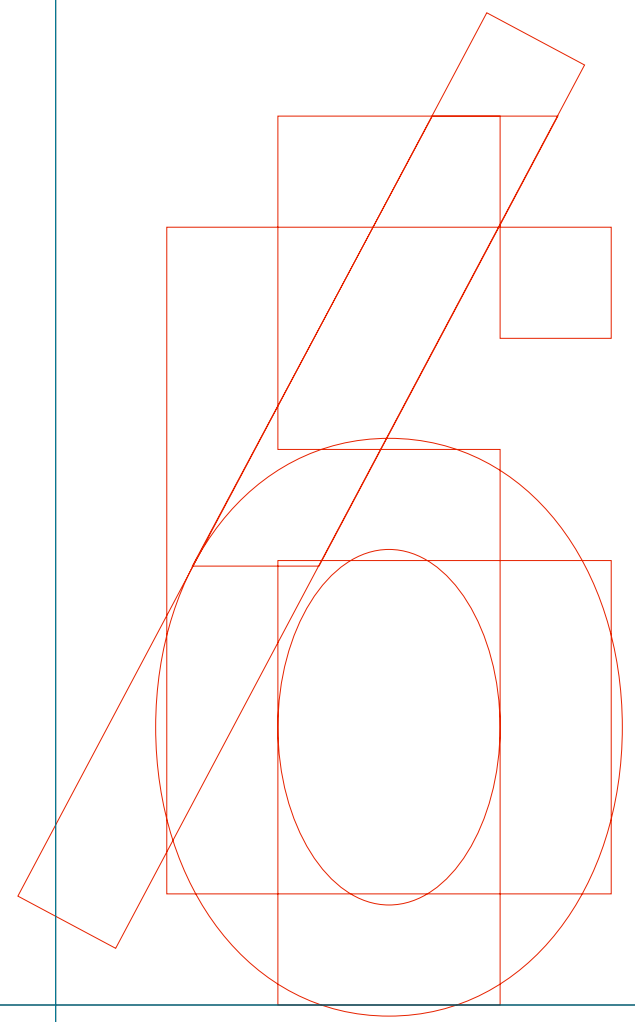
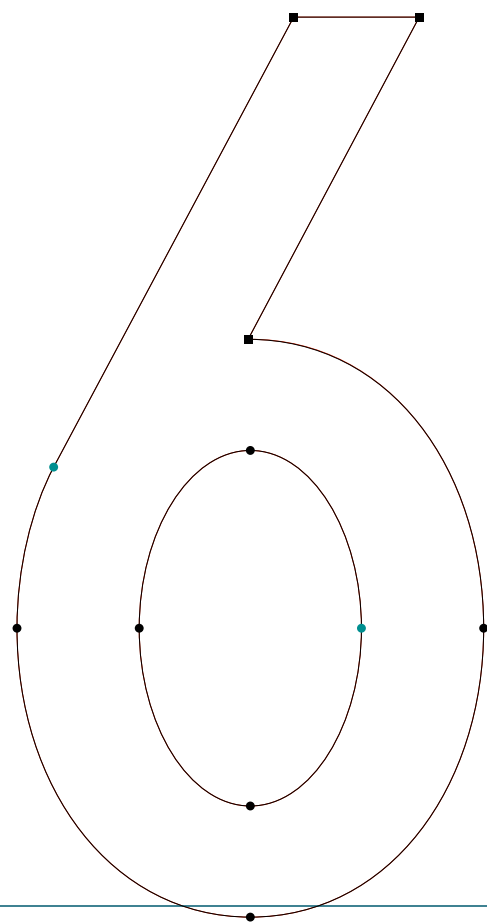

**BASE 9 & 12**

.....  
BaseTwelve Sans | seven | RoboFog Sketches | 1995 | Emigre Fonts

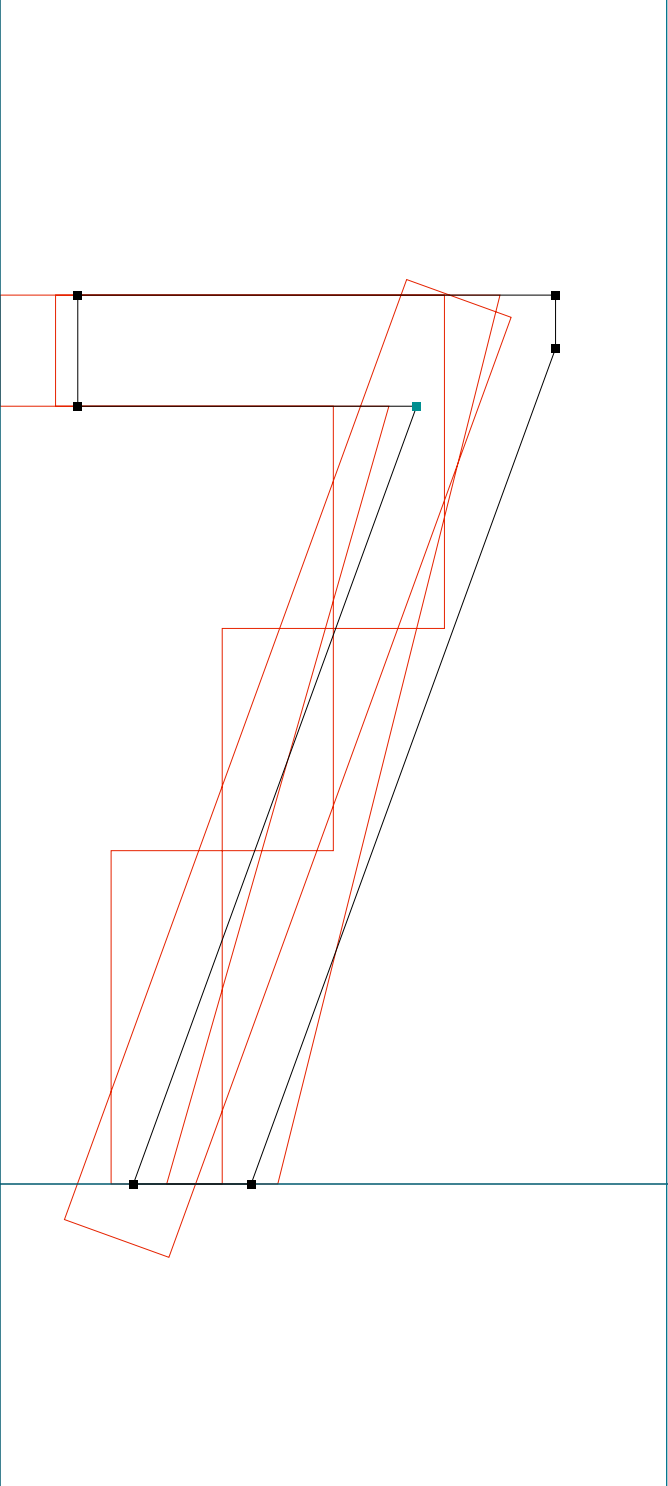

**BASE 9 & 12**

.....  
BaseTwelve Sans | eight | RoboFog Sketches | 1995 | Emigre Fonts

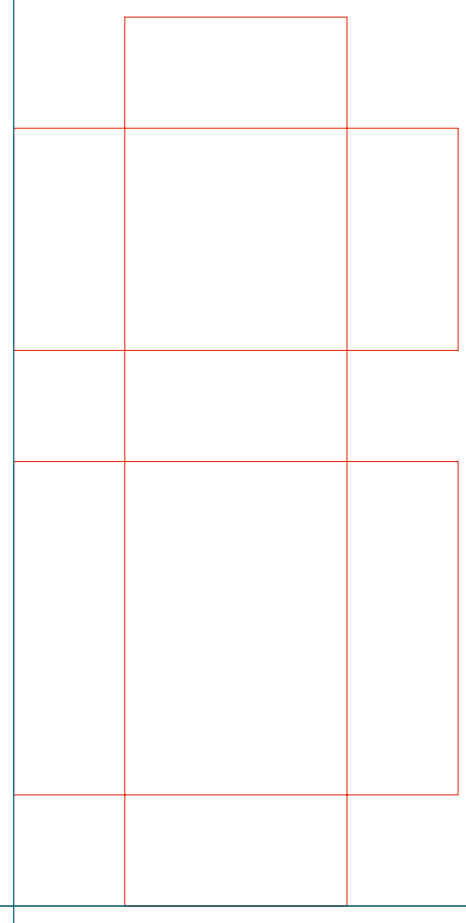
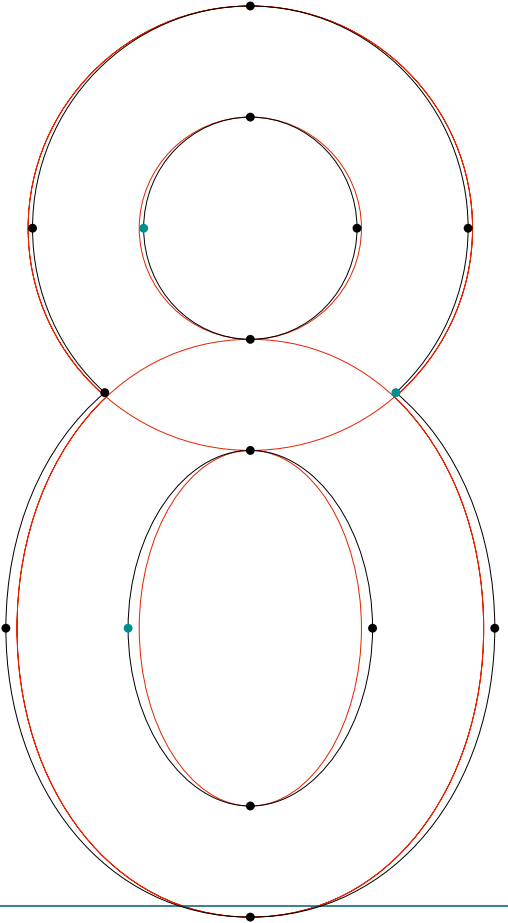
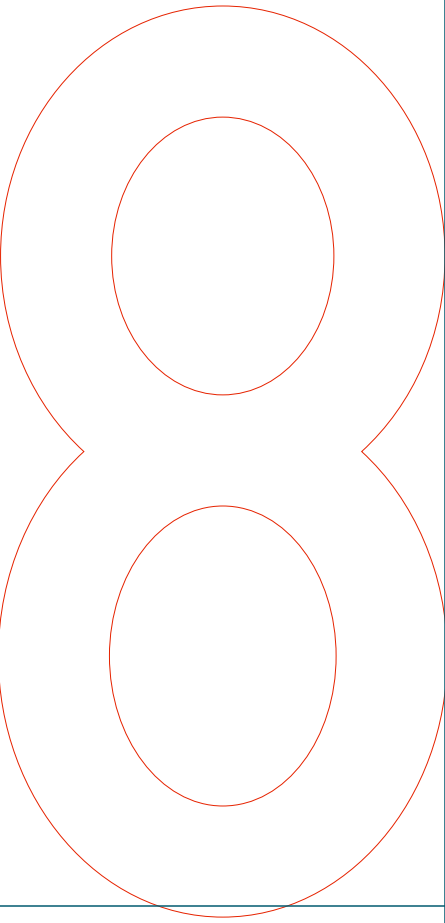
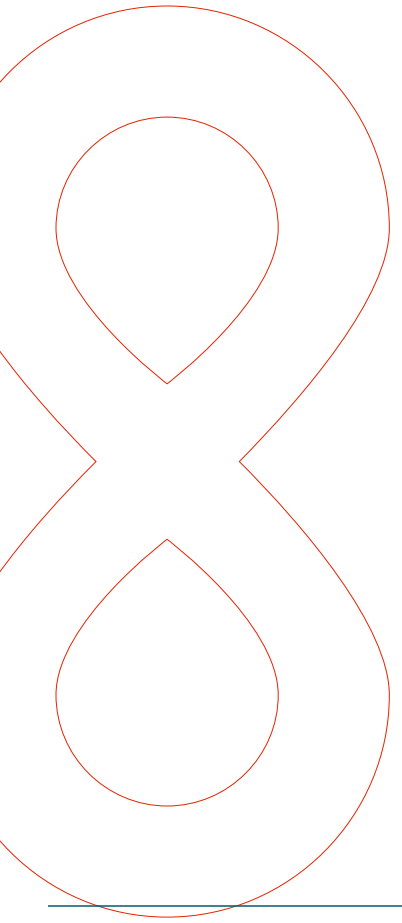

**BASE 9 & 12**

.....  
BaseTwelve Sans | nine | RoboFog Sketches | 1995 | Emigre Fonts

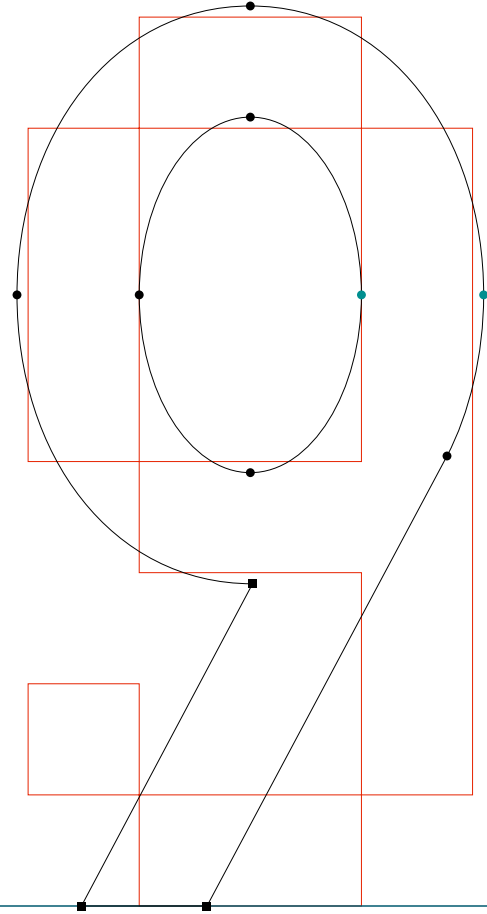

**BASE 9 & 12**

BaseTwelve Sans | question | RoboFog Sketches | 1995 | Emigre Fonts

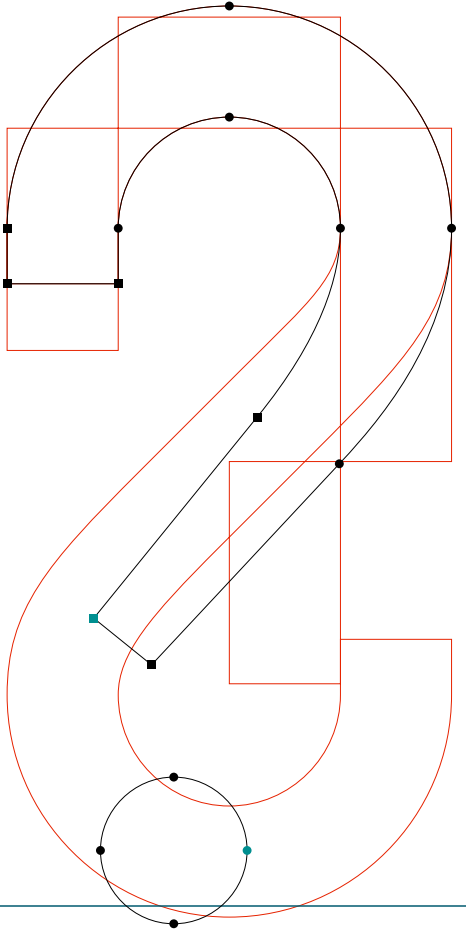

**BASE 9 & 12**

.....  
BaseTwelve Sans | A | RoboFog Sketches | 1995 | Emigre Fonts

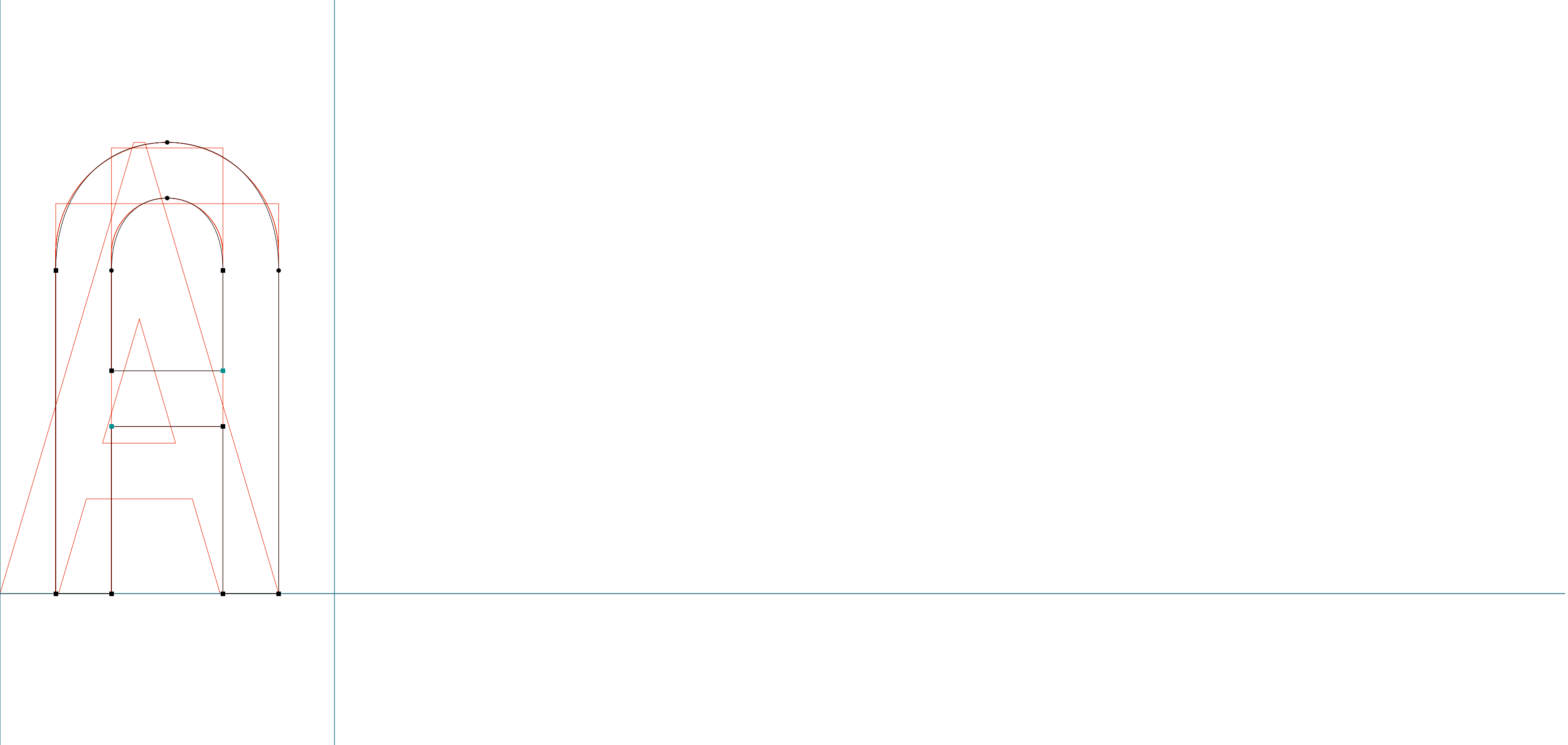

**BASE 9 & 12**

.....  
BaseTwelve Sans | B | RoboFog Sketches | 1995 | Emigre Fonts

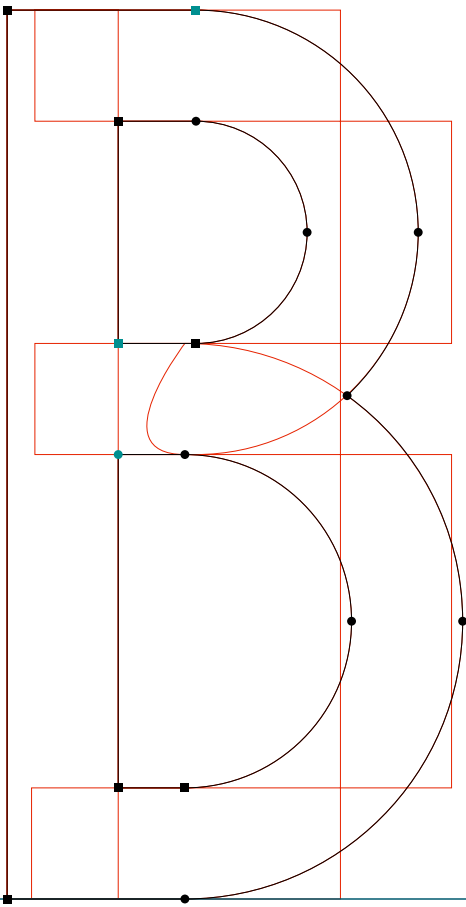

**BASE 9 & 12**

BaseTwelve Sans | C | RoboFog Sketches | 1995 | Emigre Fonts

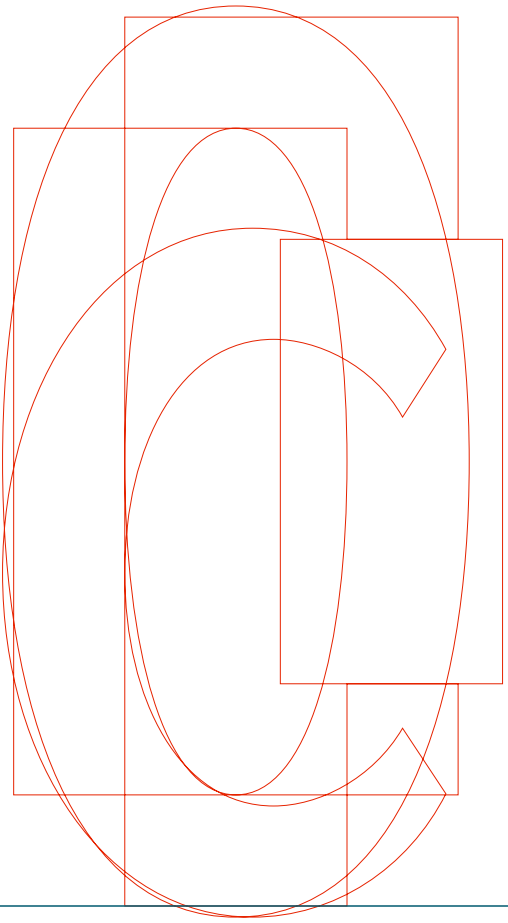
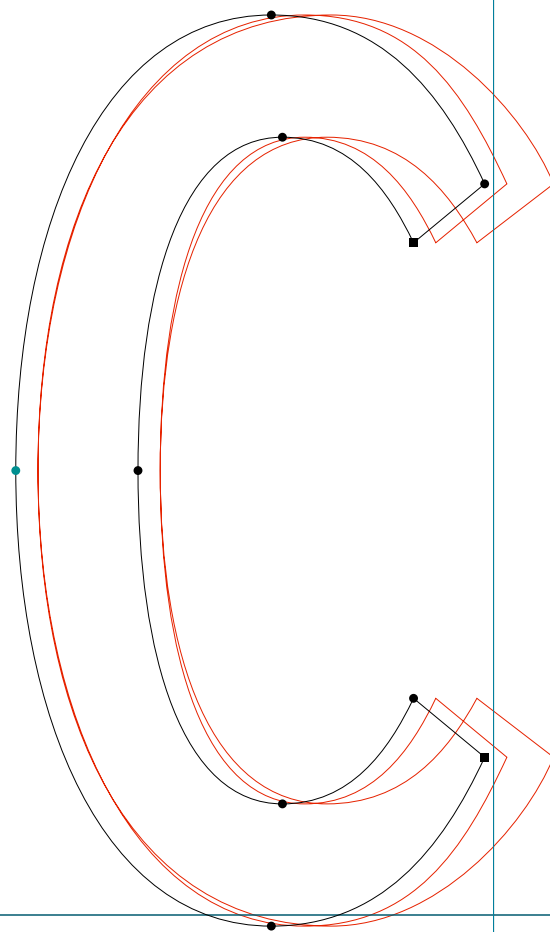



**BASE 9 & 12**

.....  
BaseTwelve Sans | D | RoboFog Sketches | 1995 | Emigre Fonts

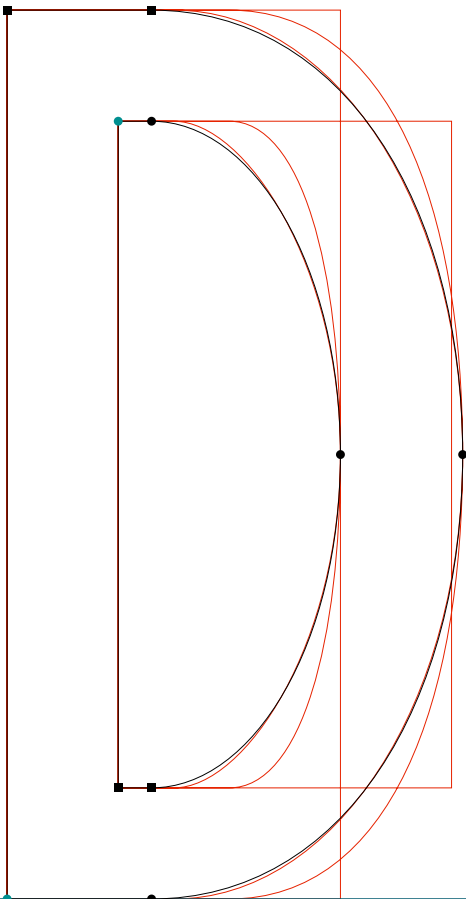

**BASE 9 & 12**

.....  
BaseTwelve Sans | G | RoboFog Sketches | 1995 | Emigre Fonts

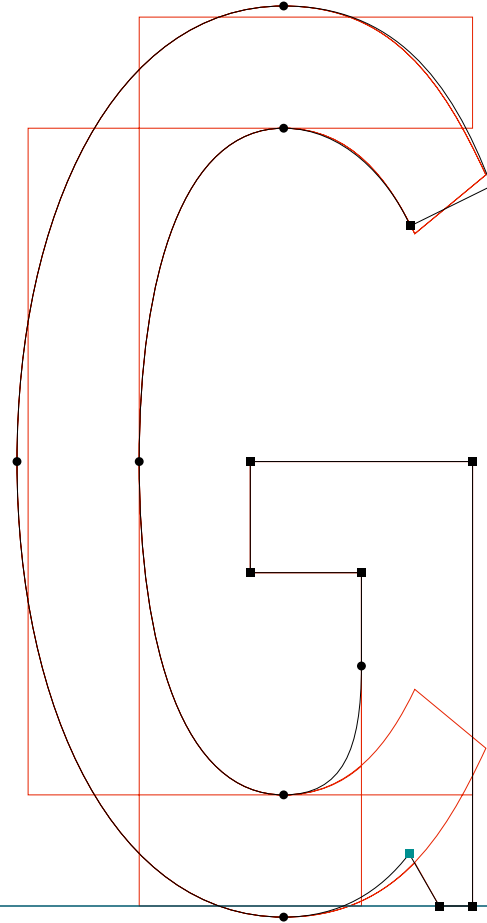

**BASE 9 & 12**

.....  
BaseTwelve Sans | K | RoboFog Sketches | 1995 | Emigre Fonts

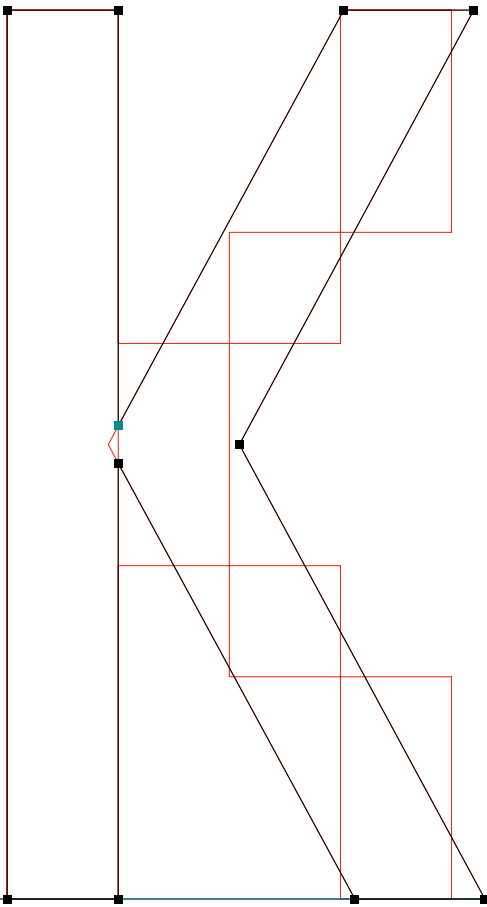

**BASE 9 & 12**

BaseTwelve Sans | M | RoboFog Sketches | 1995 | Emigre Fonts

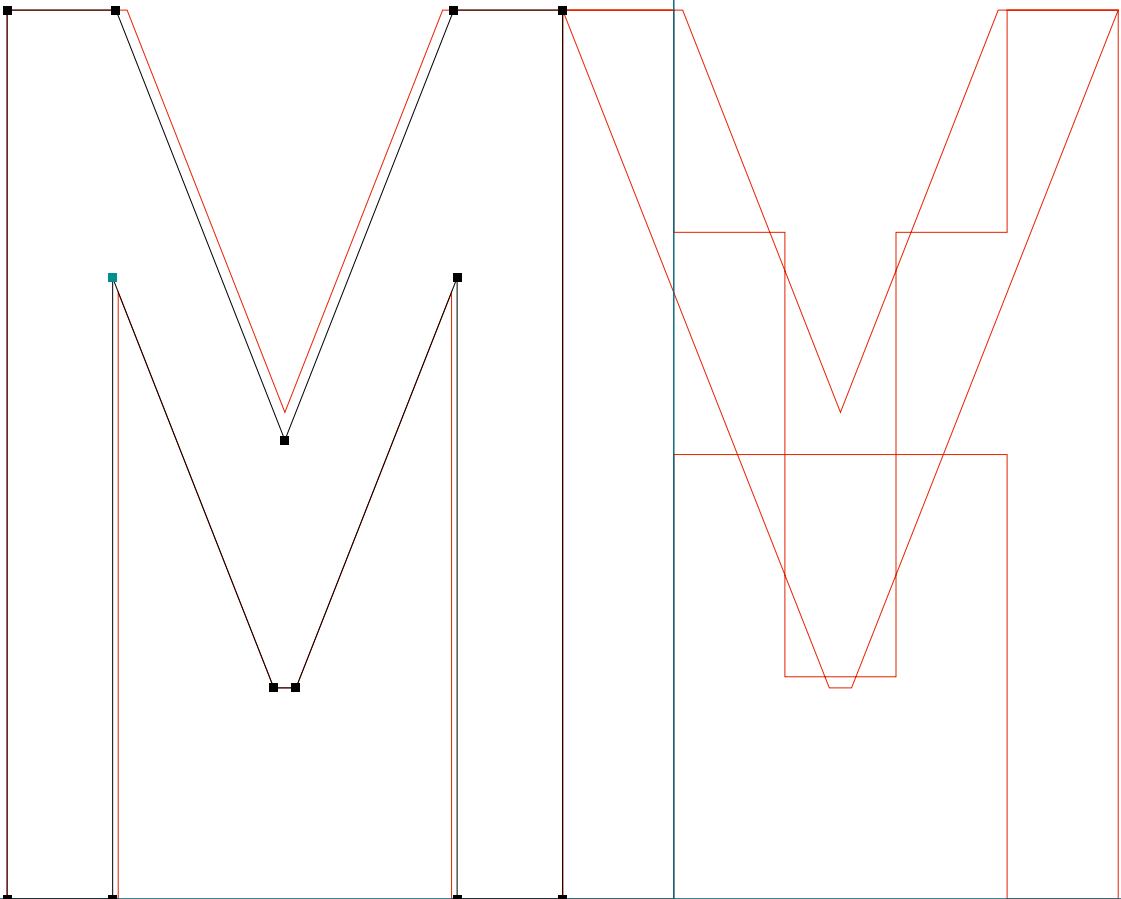

**BASE 9 & 12**

.....  
BaseTwelve Sans | N | RoboFog Sketches | 1995 | Emigre Fonts

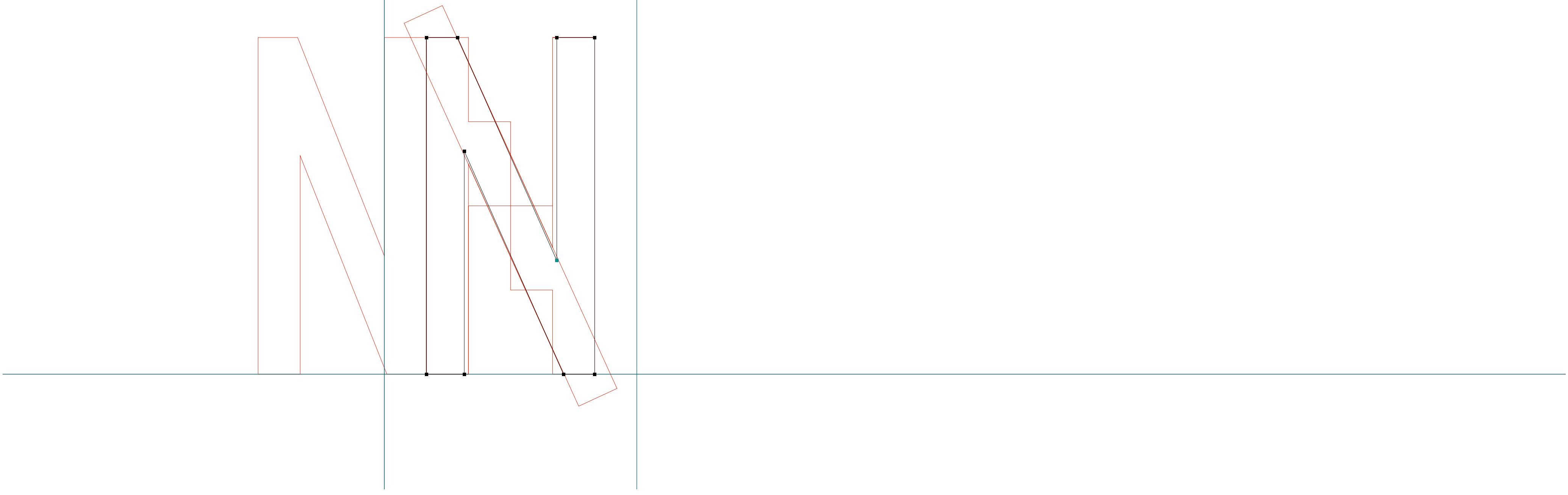

**BASE 9 & 12**

.....  
BaseTwelve Sans | 0 | RoboFog Sketches | 1995 | Emigre Fonts

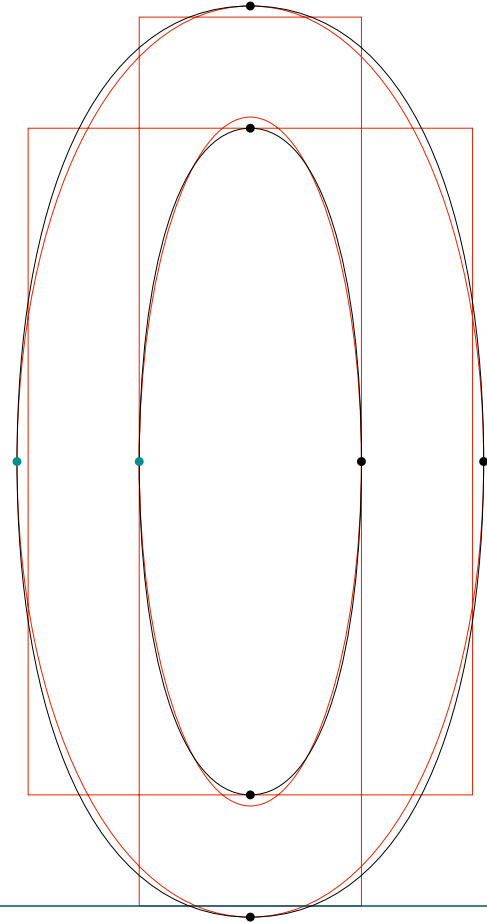

**BASE 9 & 12**

.....  
BaseTwelve Sans | P | RoboFog Sketches | 1995 | Emigre Fonts



**BASE 9 & 12**

.....  
BaseTwelve Sans | Q | RoboFog Sketches | 1995 | Emigre Fonts

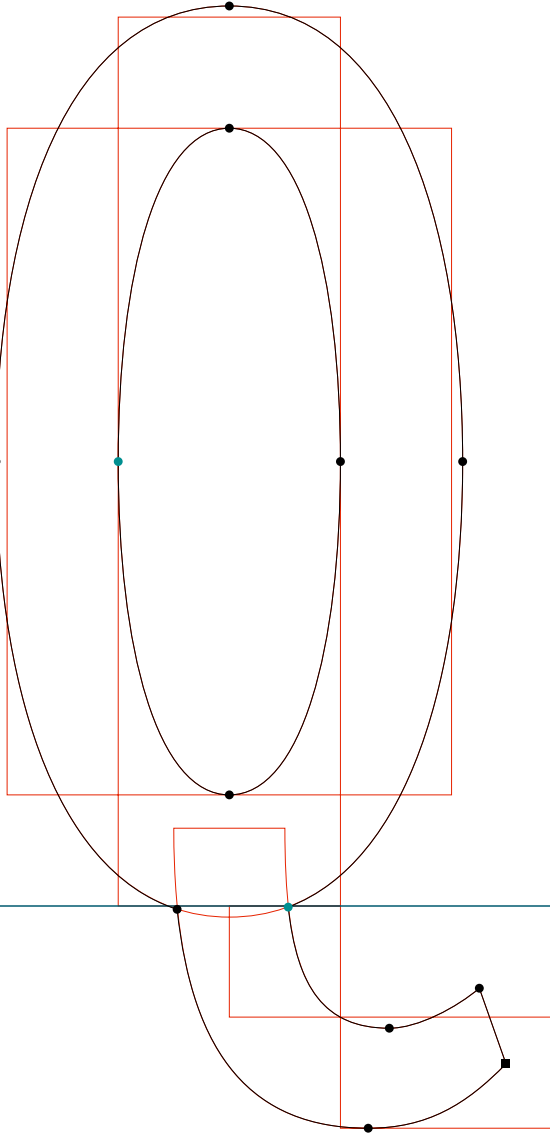



**BASE 9 & 12**

.....  
BaseTwelve Sans | R | RoboFog Sketches | 1995 | Emigre Fonts

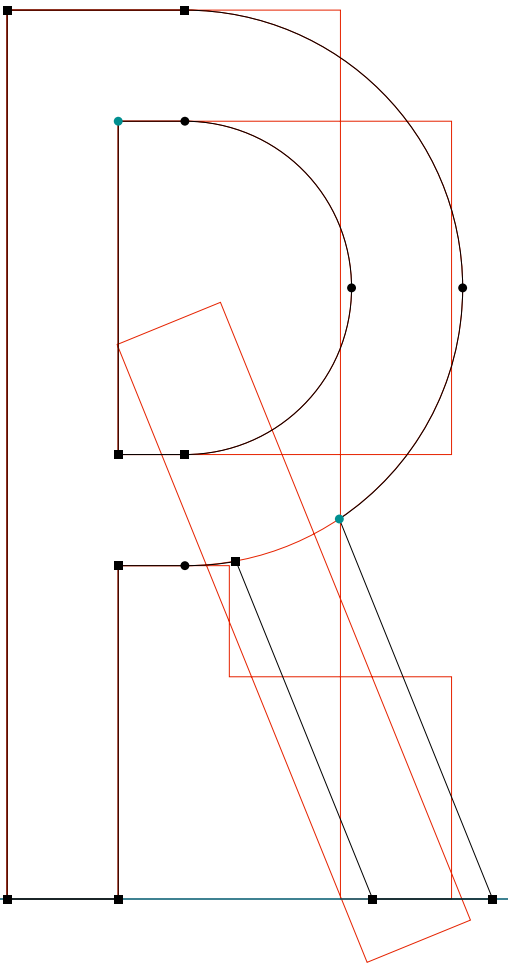

**BASE 9 & 12**

.....  
BaseTwelve Sans | U | RoboFog Sketches | 1995 | Emigre Fonts

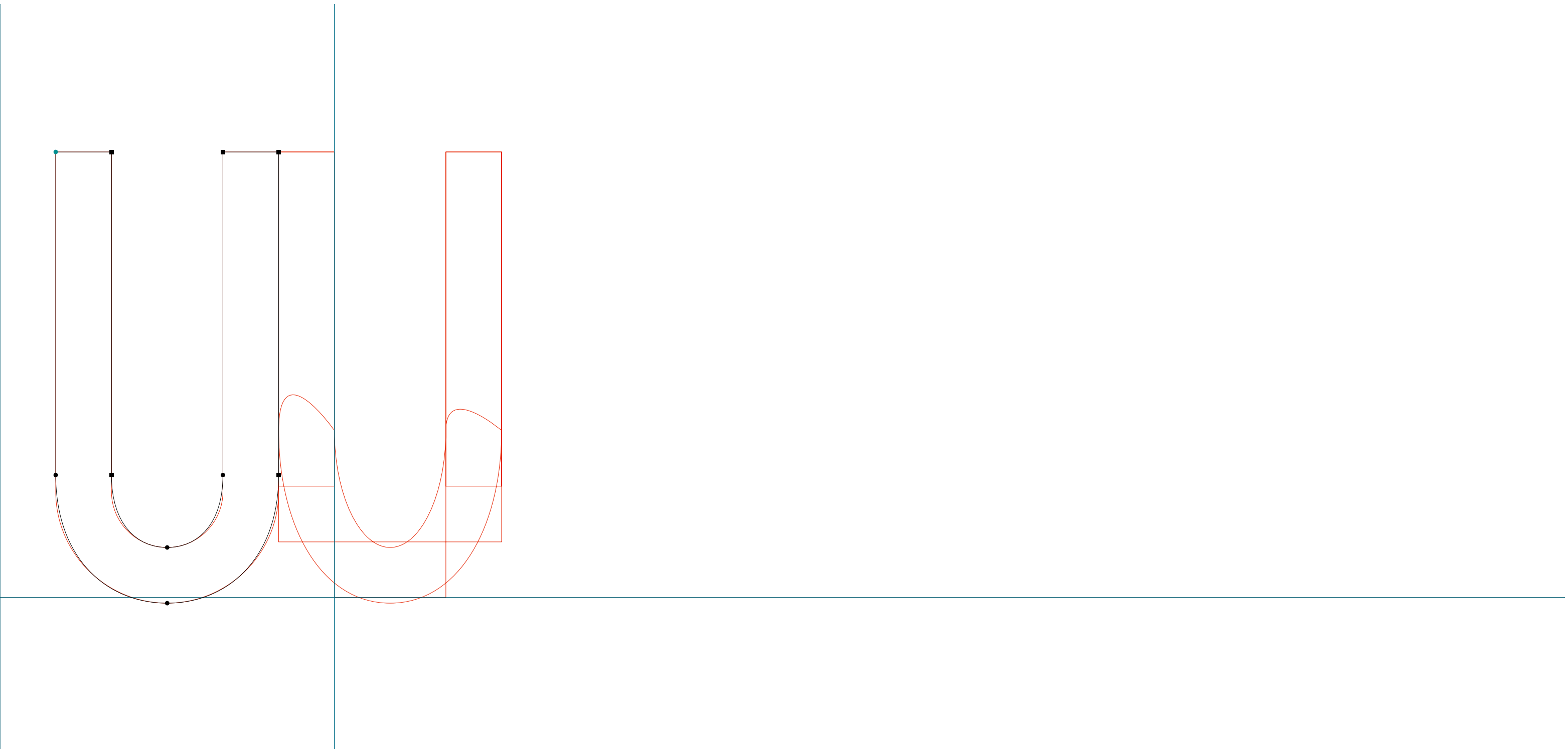

**BASE 9 & 12**

BaseTwelve Sans | V | RoboFog Sketches | 1995 | Emigre Fonts

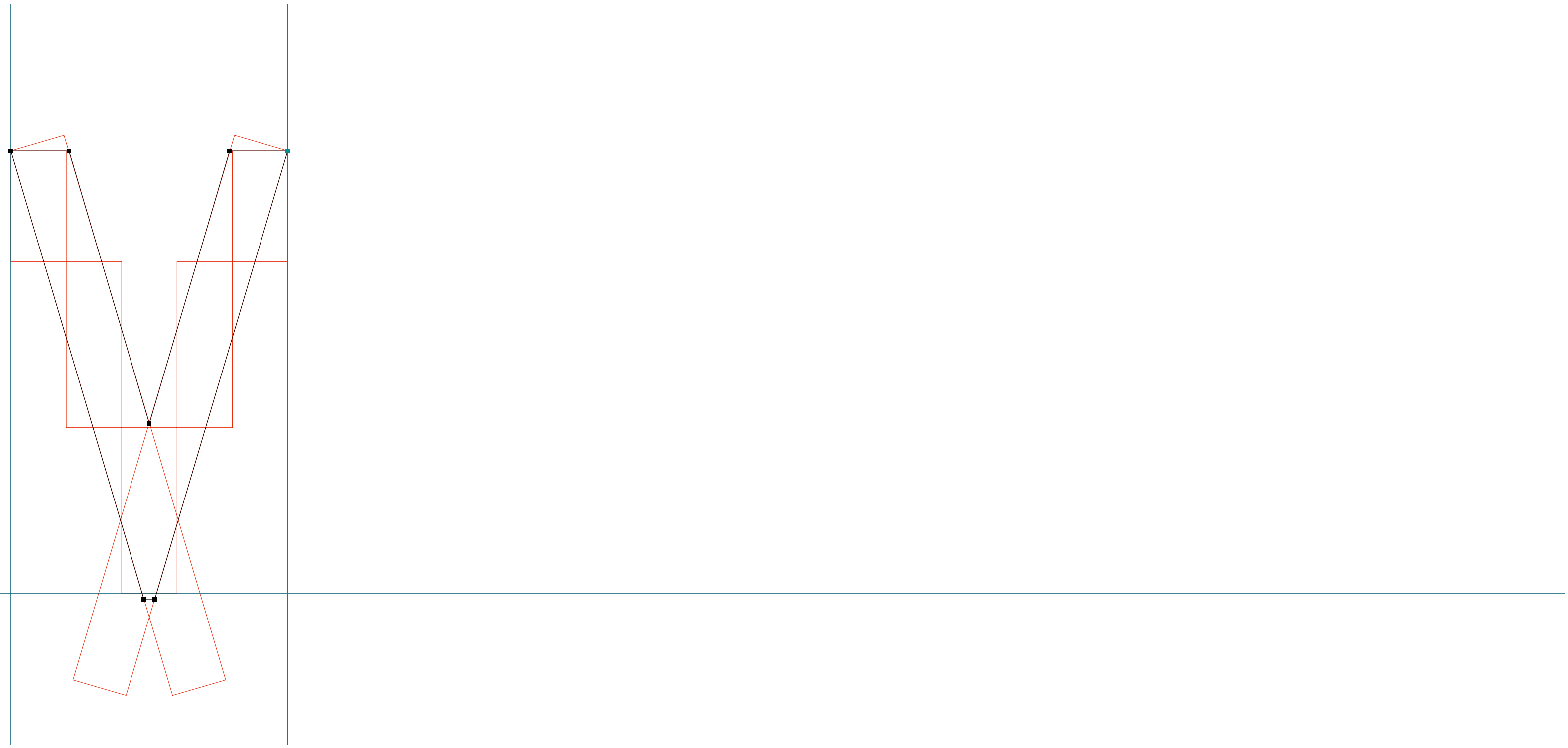

**BASE 9 & 12**

.....  
BaseTwelve Sans | W | RoboFog Sketches | 1995 | Emigre Fonts

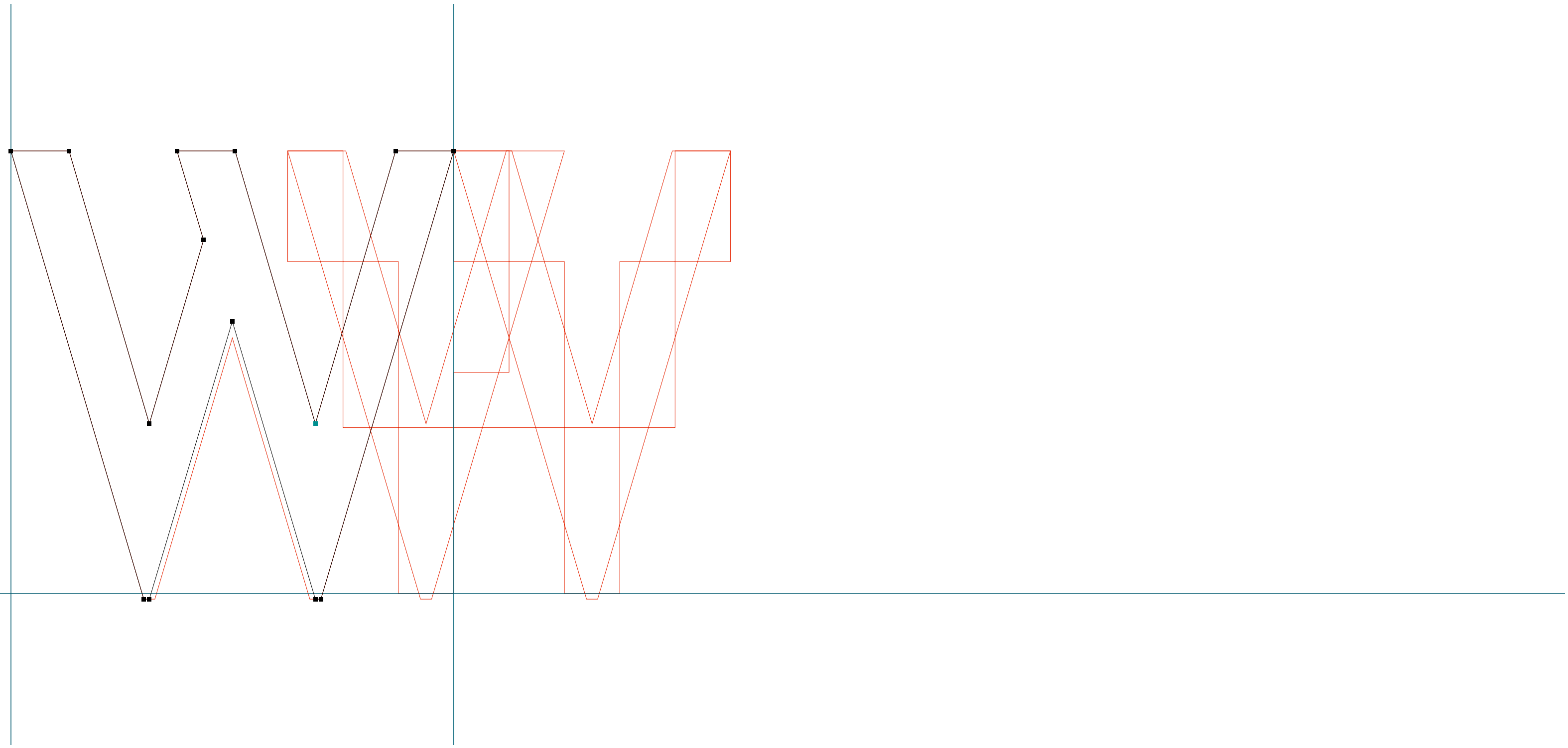

**BASE 9 & 12**

BaseTwelve Sans | Y | RoboFog Sketches | 1995 | Emigre Fonts

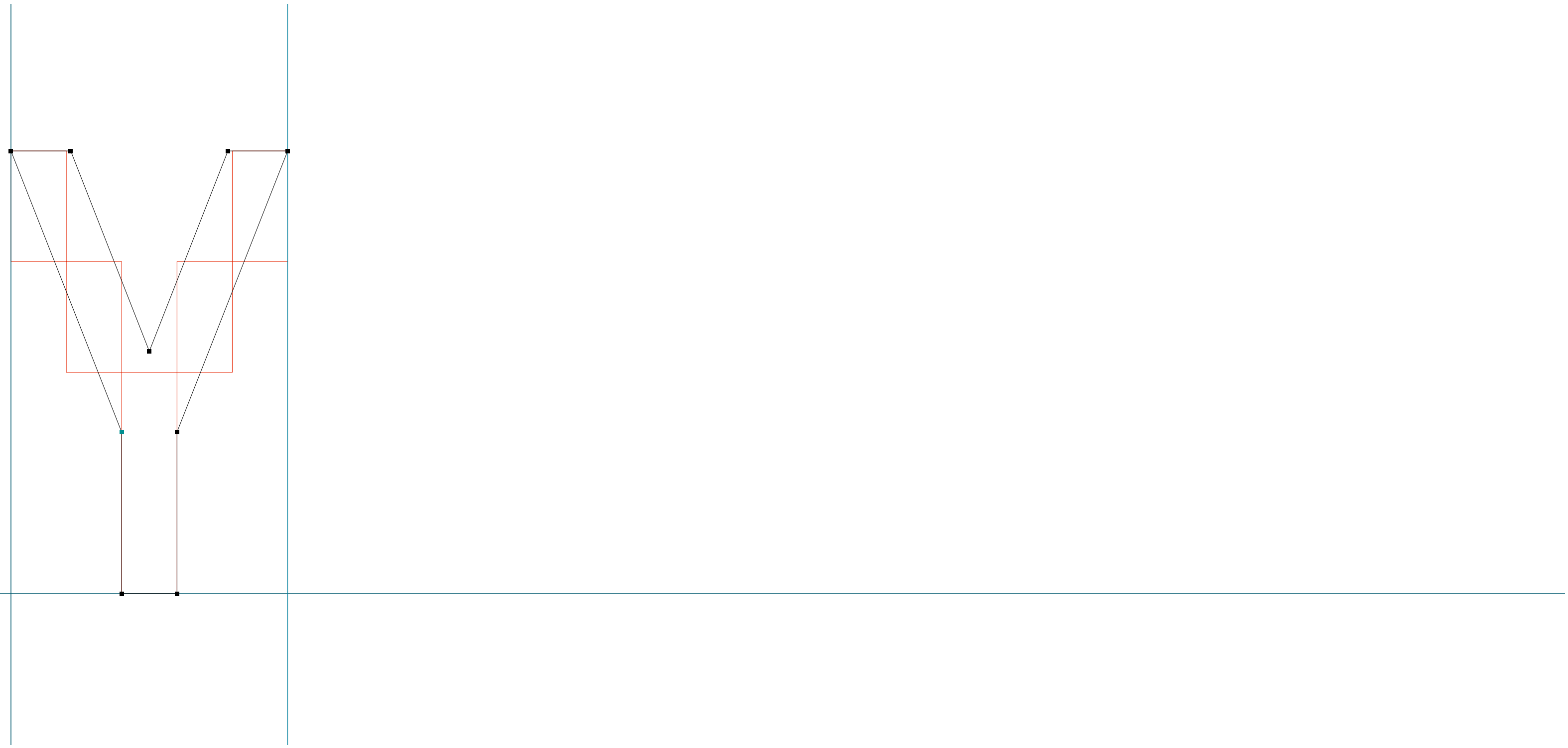

**BASE 9 & 12**

.....  
BaseTwelve Sans | b | RoboFog Sketches | 1995 | Emigre Fonts

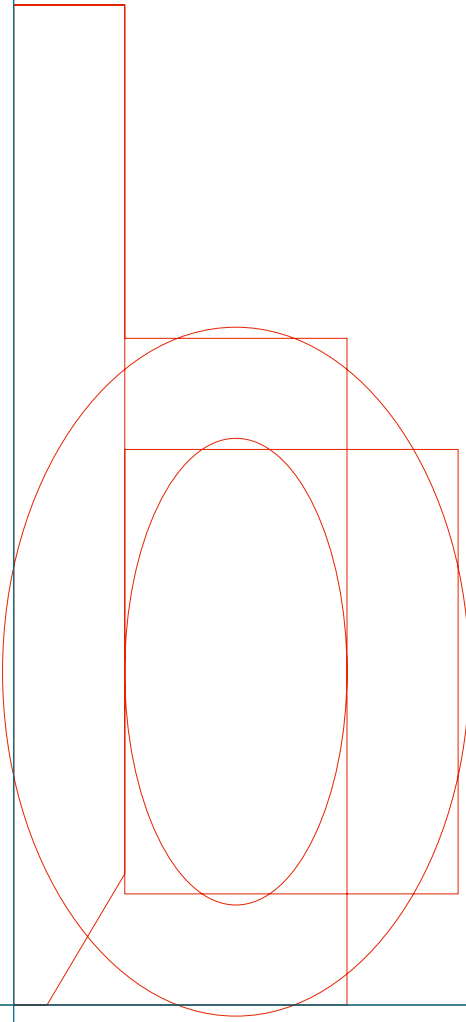
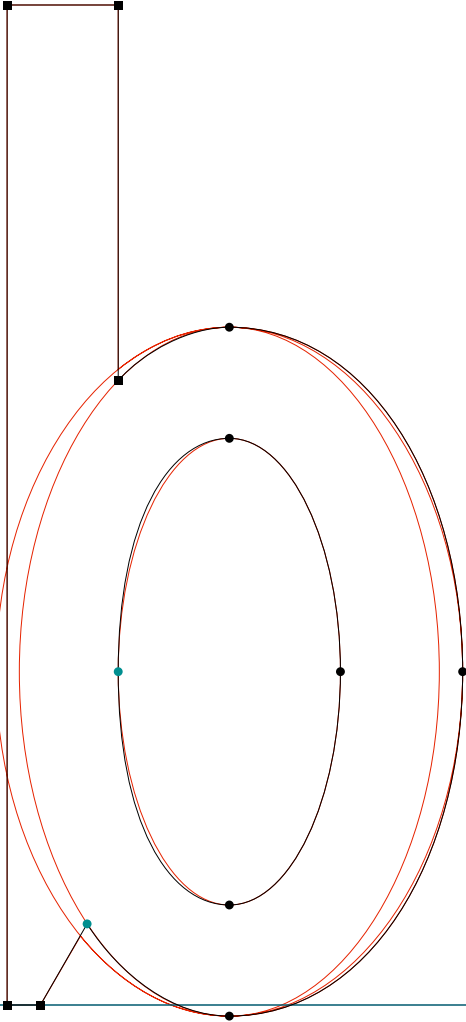

**BASE 9 & 12**

BaseTwelve Sans | c | RoboFog Sketches | 1995 | Emigre Fonts

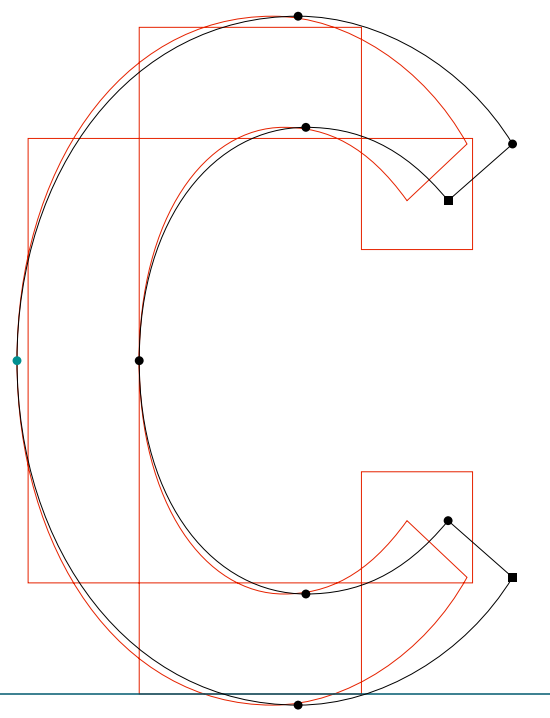

**BASE 9 & 12**

.....  
BaseTwelve Sans | d | RoboFog Sketches | 1995 | Emigre Fonts

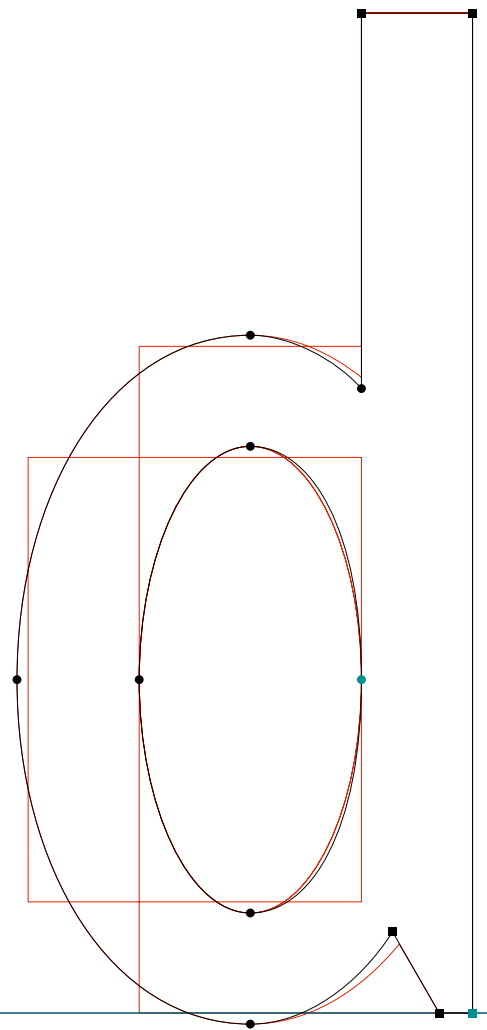



**BASE 9 & 12**

.....  
BaseTwelve Sans | e | RoboFog Sketches | 1995 | Emigre Fonts

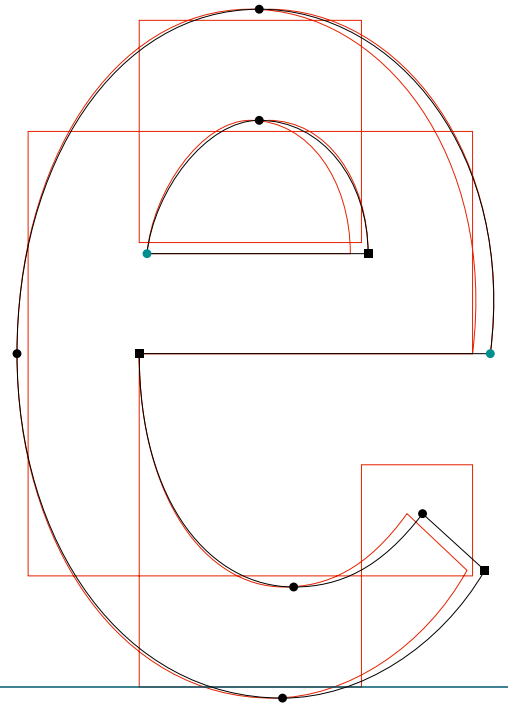
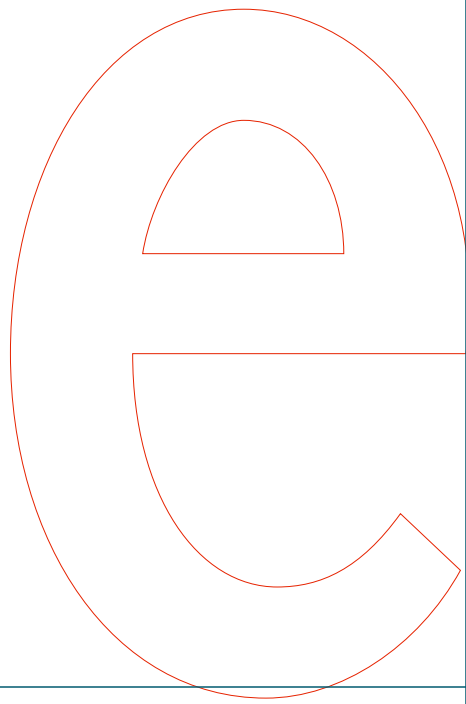

**BASE 9 & 12**

.....  
BaseTwelve Sans | f | RoboFog Sketches | 1995 | Emigre Fonts

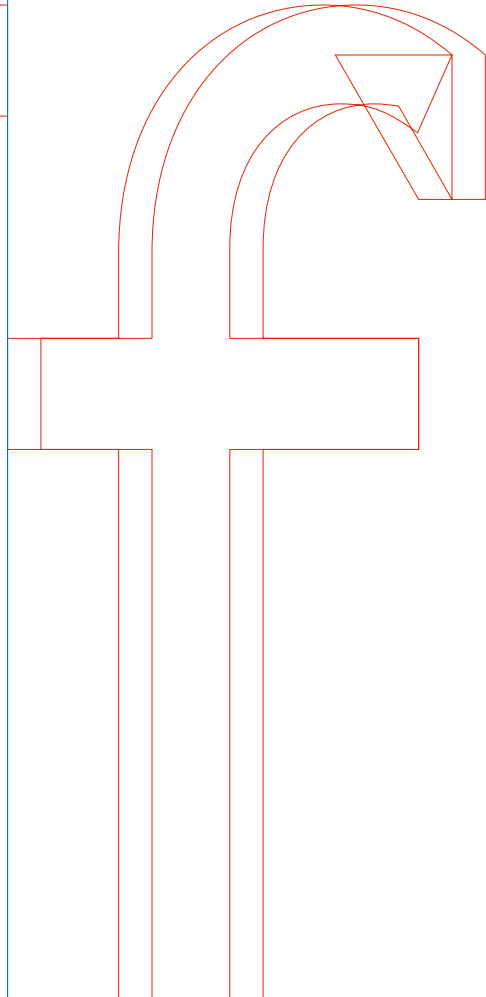
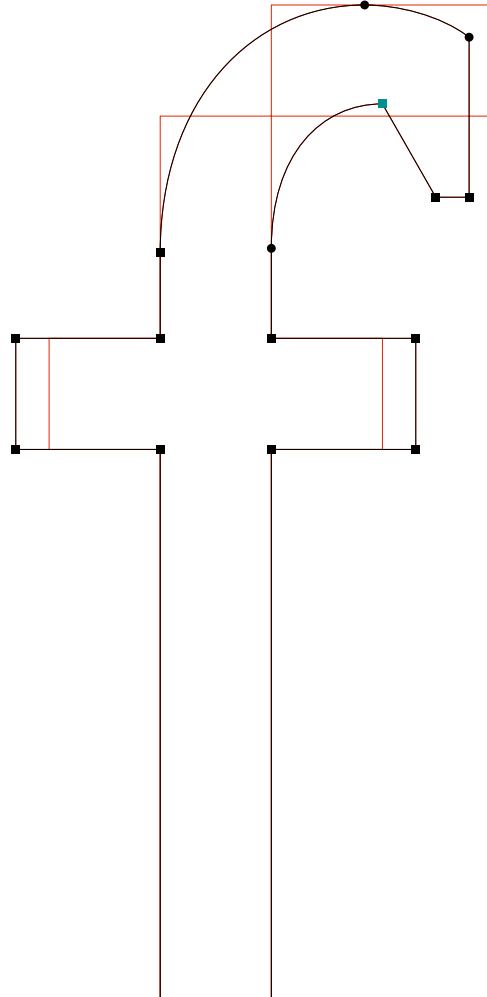
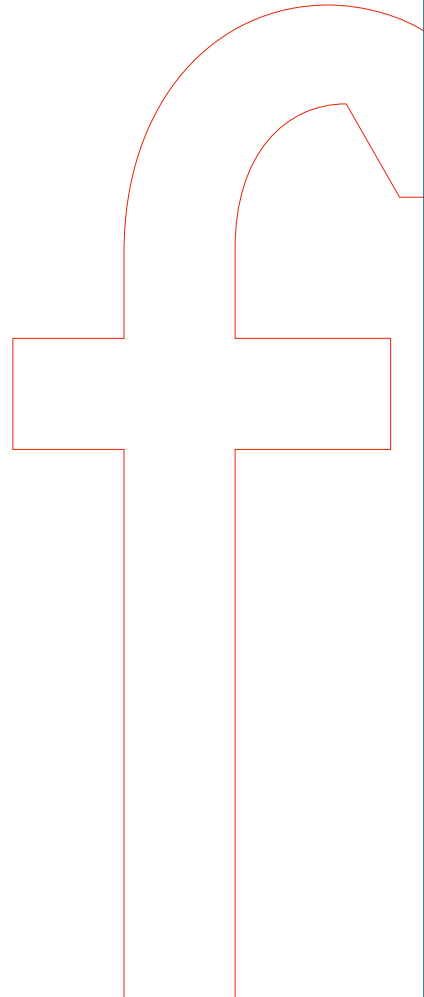

**BASE 9 & 12**

BaseTwelve Sans | i | RoboFog Sketches | 1995 | Emigre Fonts

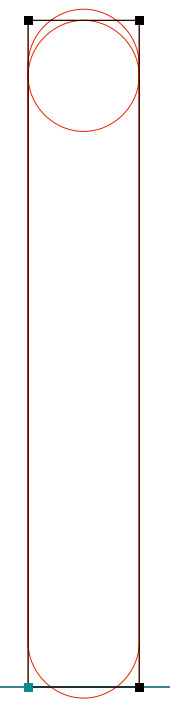
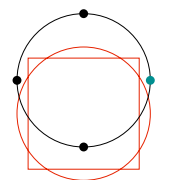

**BASE 9 & 12**

BaseTwelve Sans | j | RoboFog Sketches | 1995 | Emigre Fonts

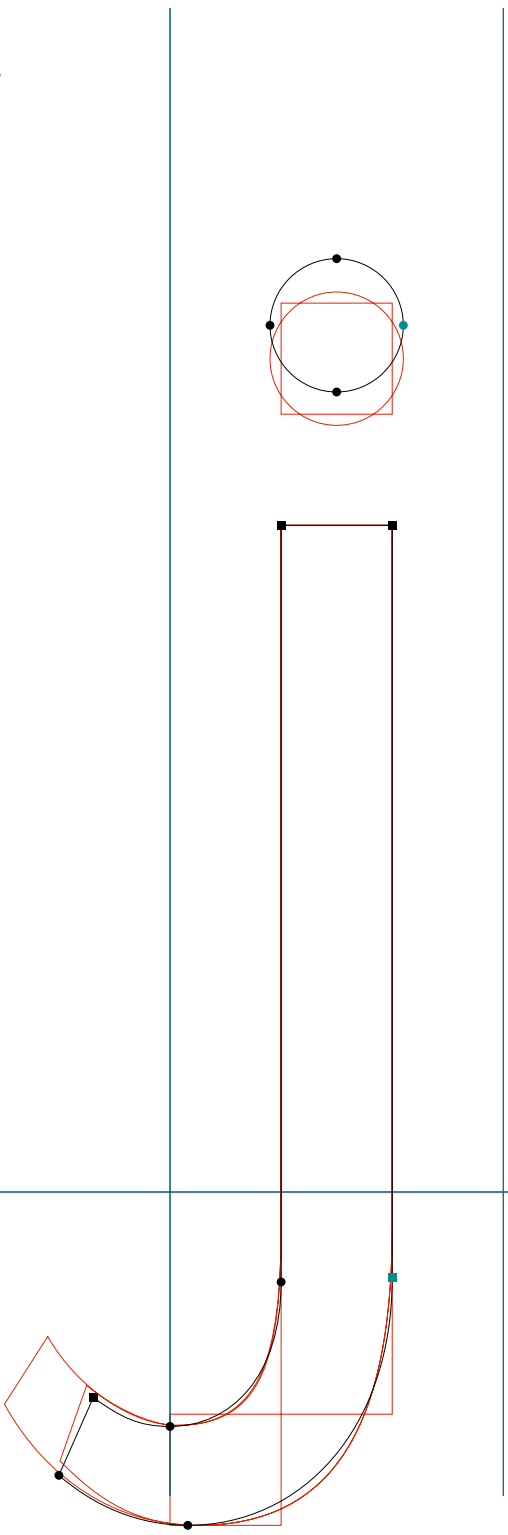

**BASE 9 & 12**

.....  
BaseTwelve Sans | k | RoboFog Sketches | 1995 | Emigre Fonts

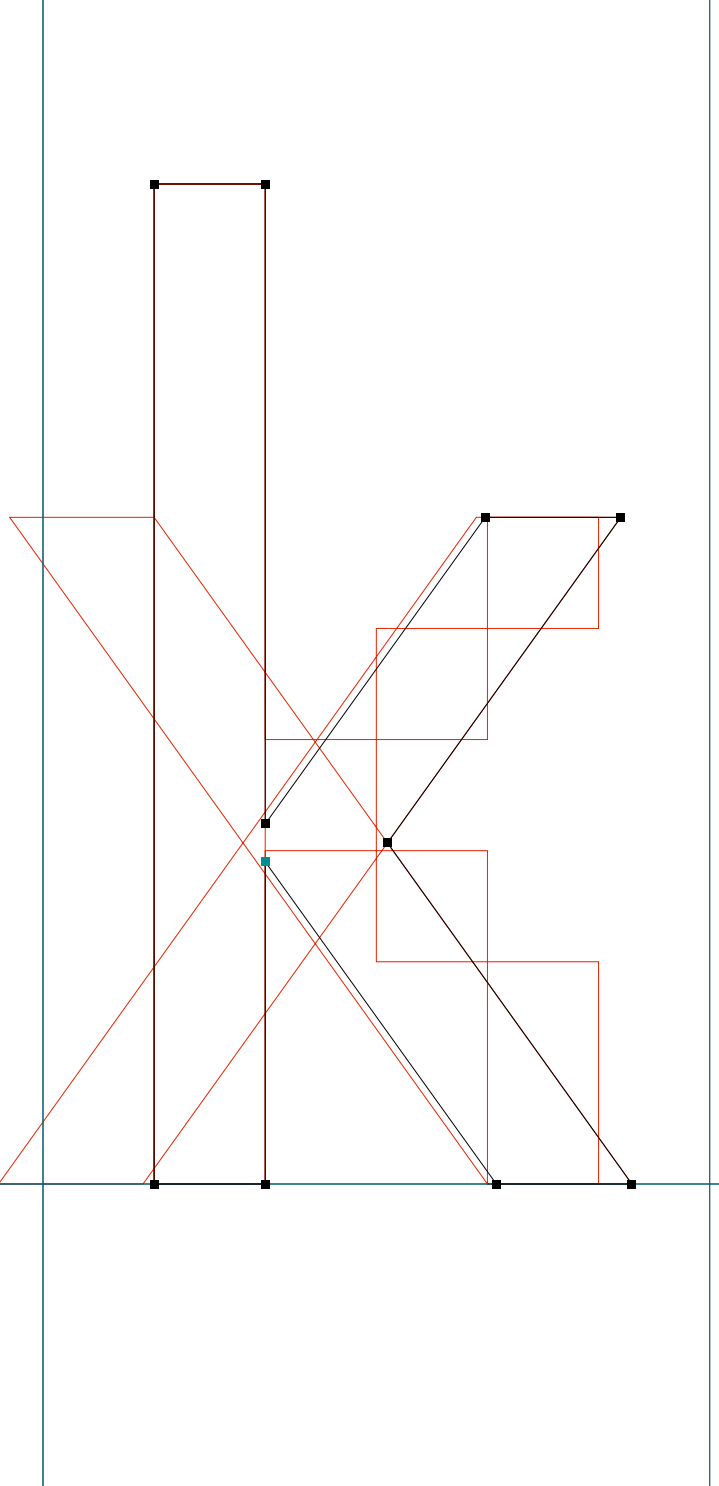

**BASE 9 & 12**

BaseTwelve Sans | m | RoboFog Sketches | 1995 | Emigre Fonts

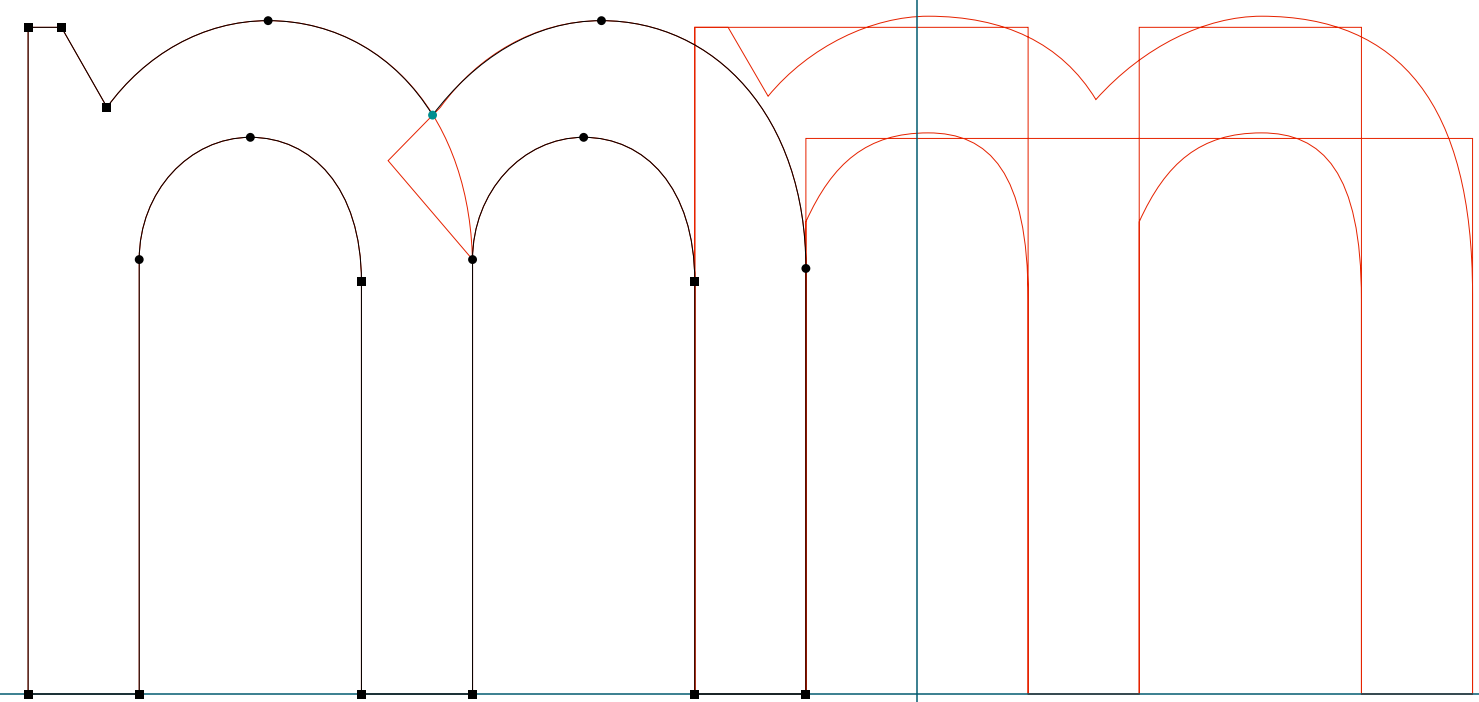

**BASE 9 & 12**

.....  
BaseTwelve Sans | n | RoboFog Sketches | 1995 | Emigre Fonts

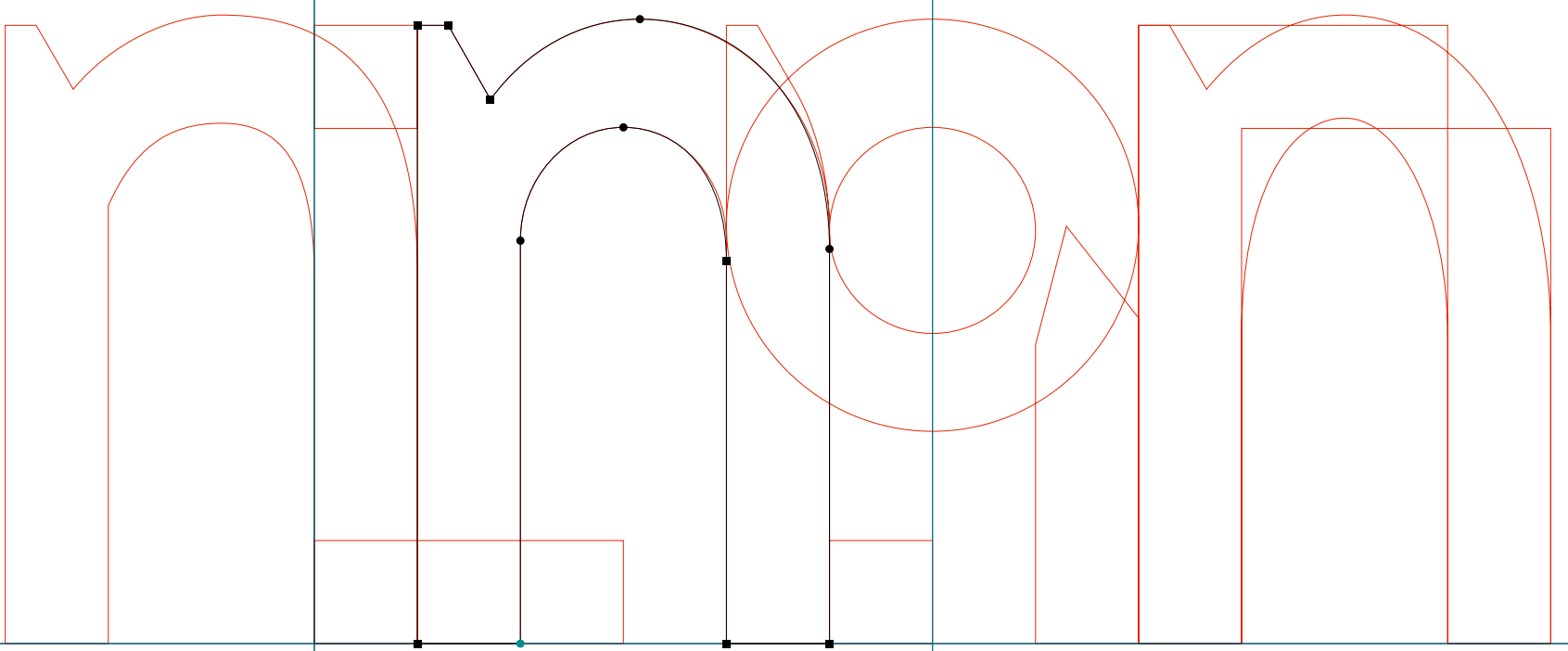

**BASE 9 & 12**

.....  
BaseTwelve Sans | o | RoboFog Sketches | 1995 | Emigre Fonts

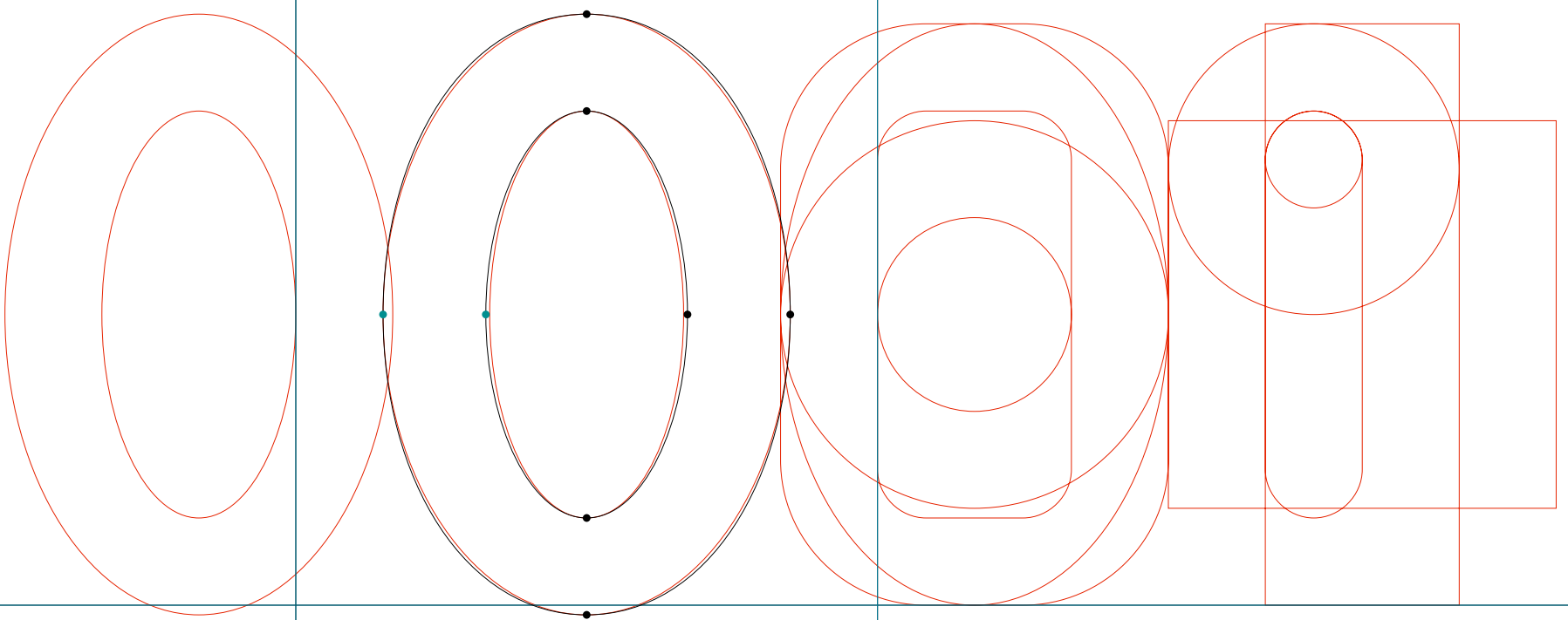



**BASE 9 & 12**

BaseTwelve Sans | r | RoboFog Sketches | 1995 | Emigre Fonts

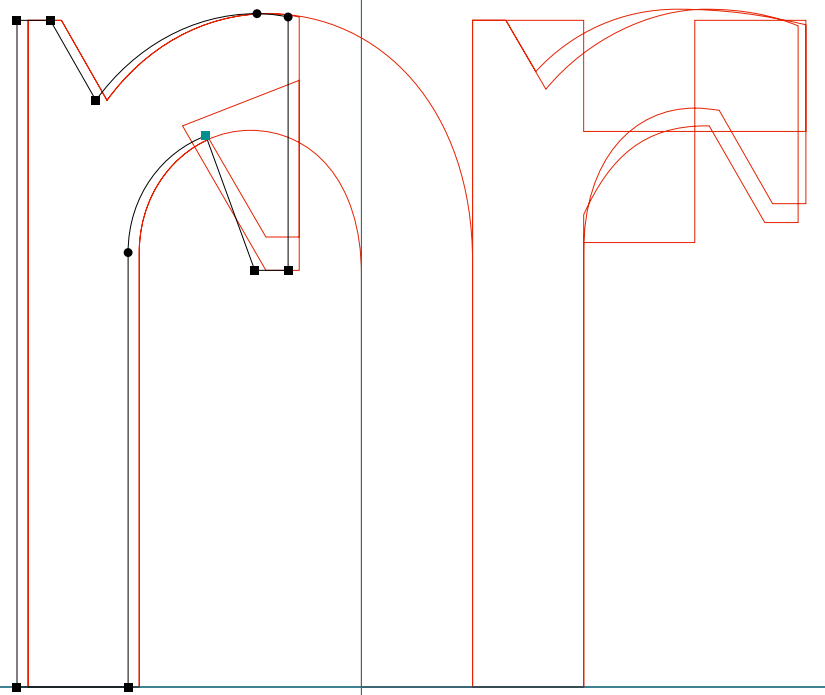

**BASE 9 & 12**

.....  
BaseTwelve Sans | s | RoboFog Sketches | 1995 | Emigre Fonts

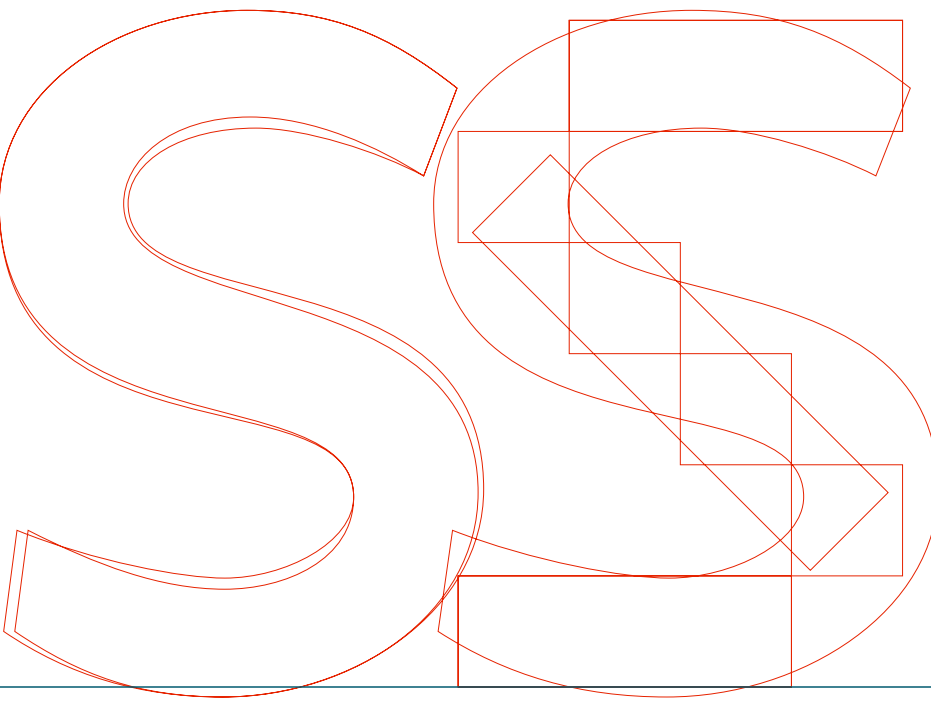
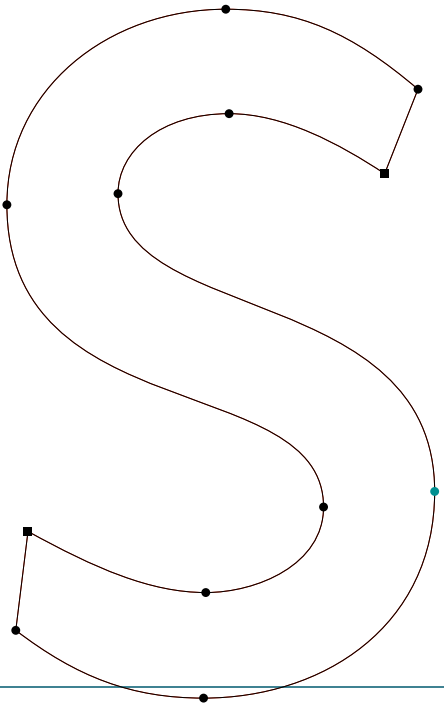
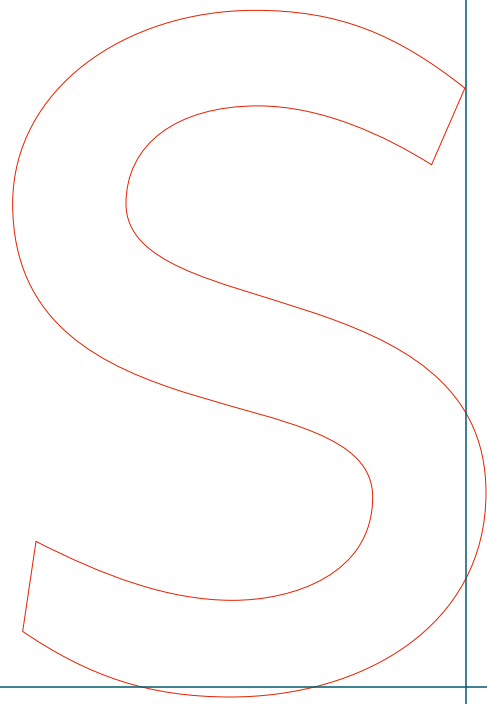

**BASE 9 & 12**

BaseTwelve Sans | t | RoboFog Sketches | 1995 | Emigre Fonts

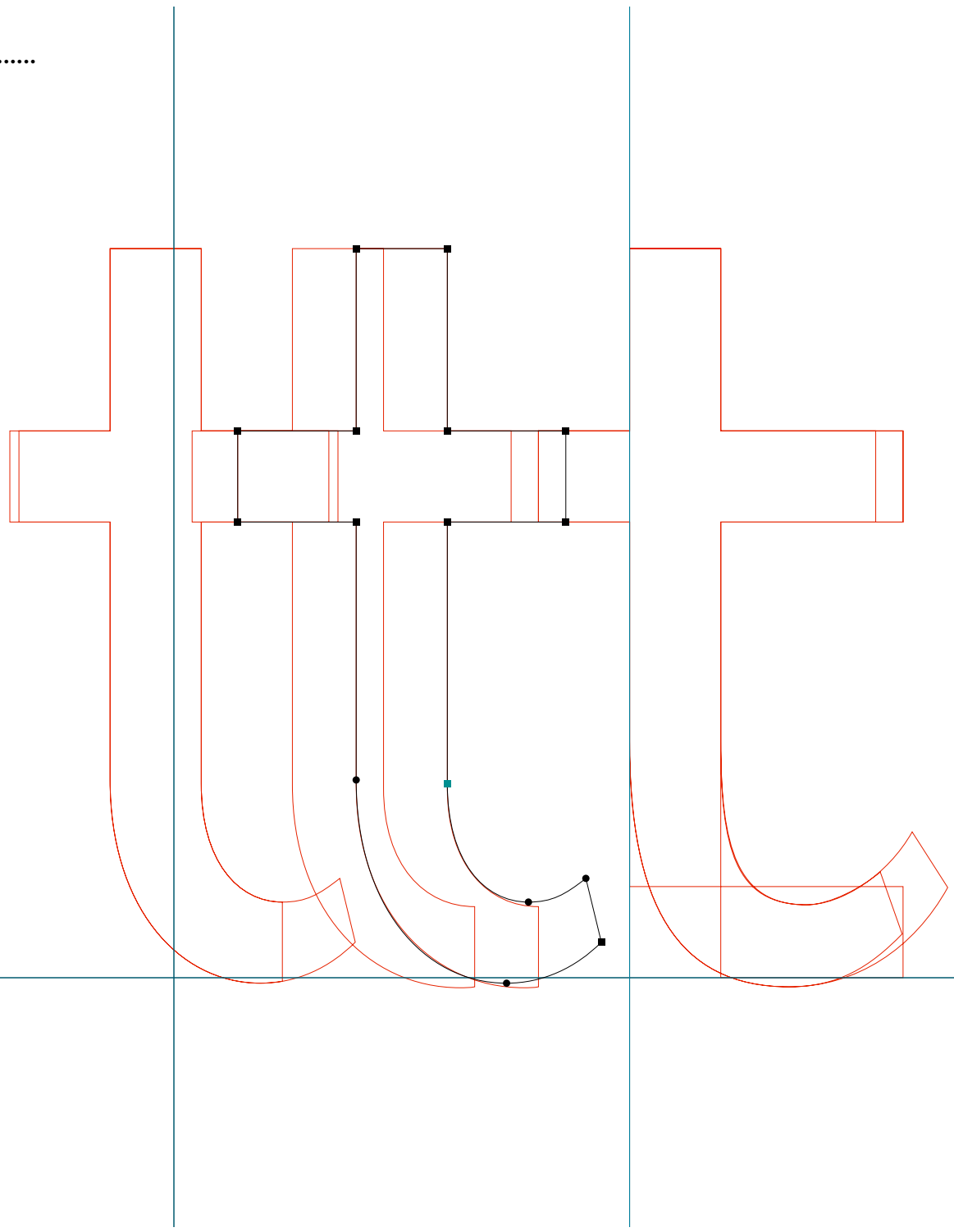

**BASE 9 & 12**

BaseTwelve Sans | v | RoboFog Sketches | 1995 | Emigre Fonts

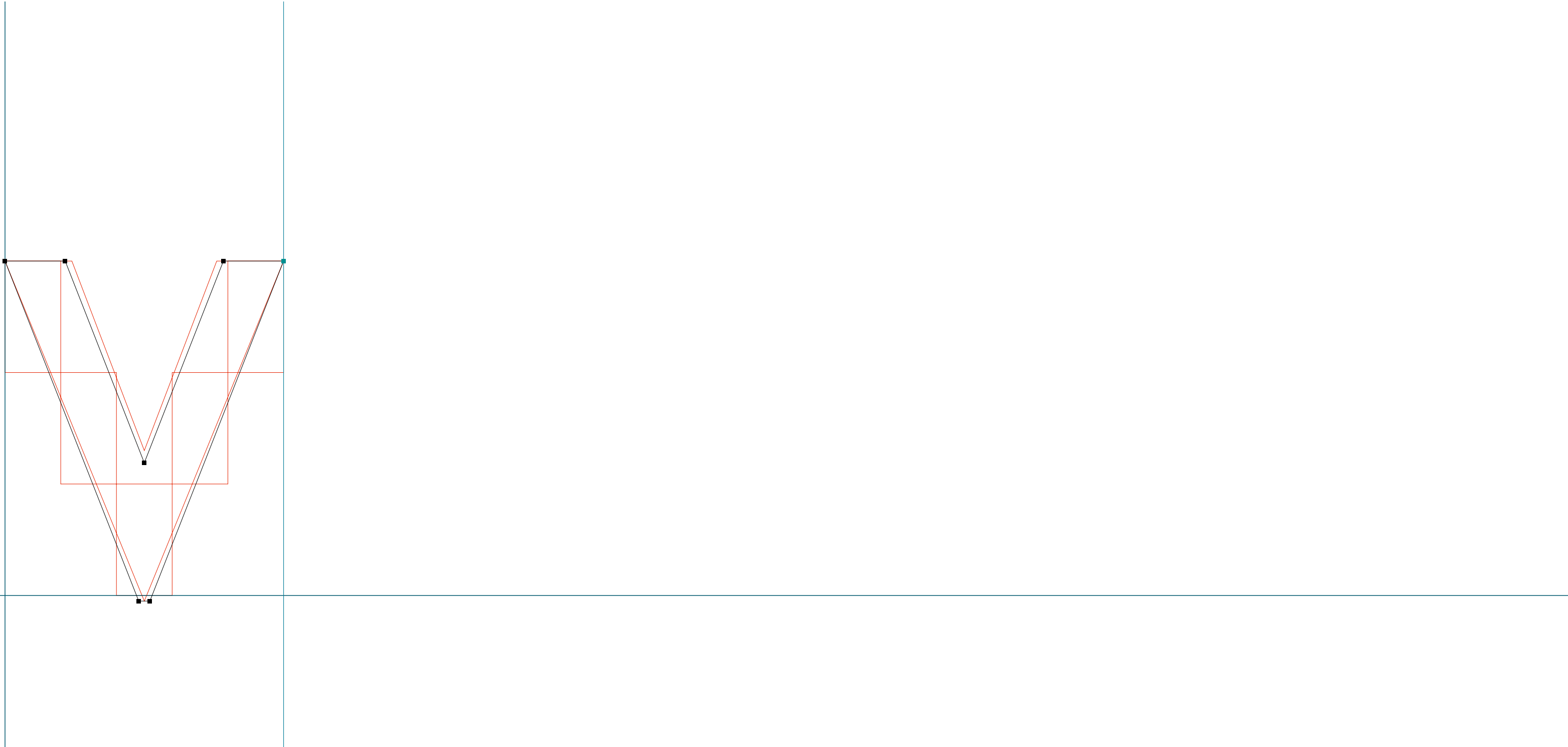

**BASE 9 & 12**

BaseTwelve Sans | x | RoboFog Sketches | 1995 | Emigre Fonts

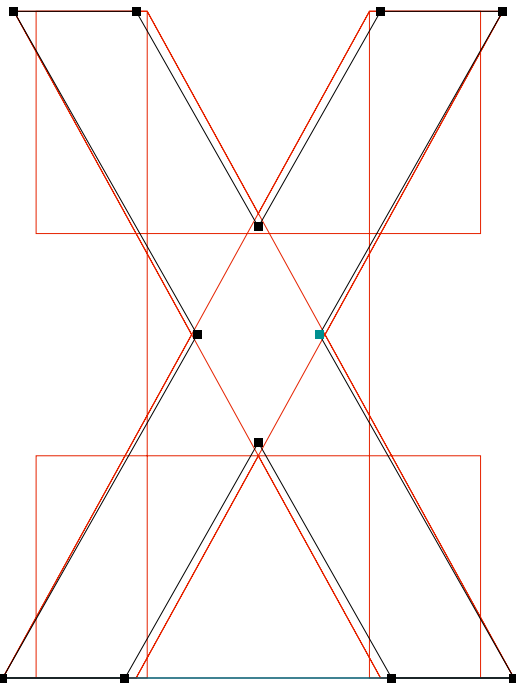

**BASE 9 & 12**

BaseTwelve Sans | y | RoboFog Sketches | 1995 | Emigre Fonts

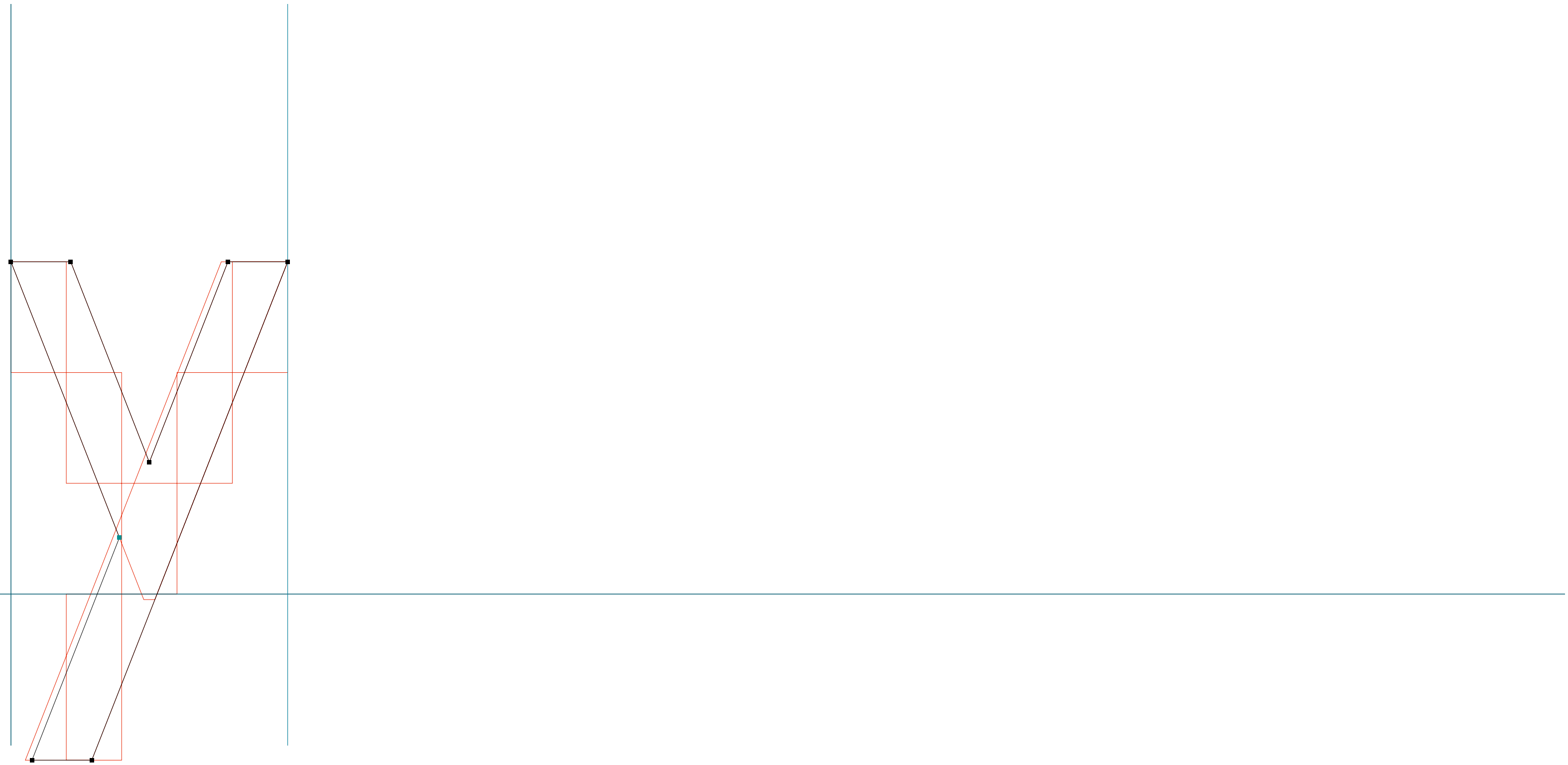

**BASE 9 & 12**

BaseTwelve Sans | braceright | RoboFog Sketches | 1995 | Emigre Fonts

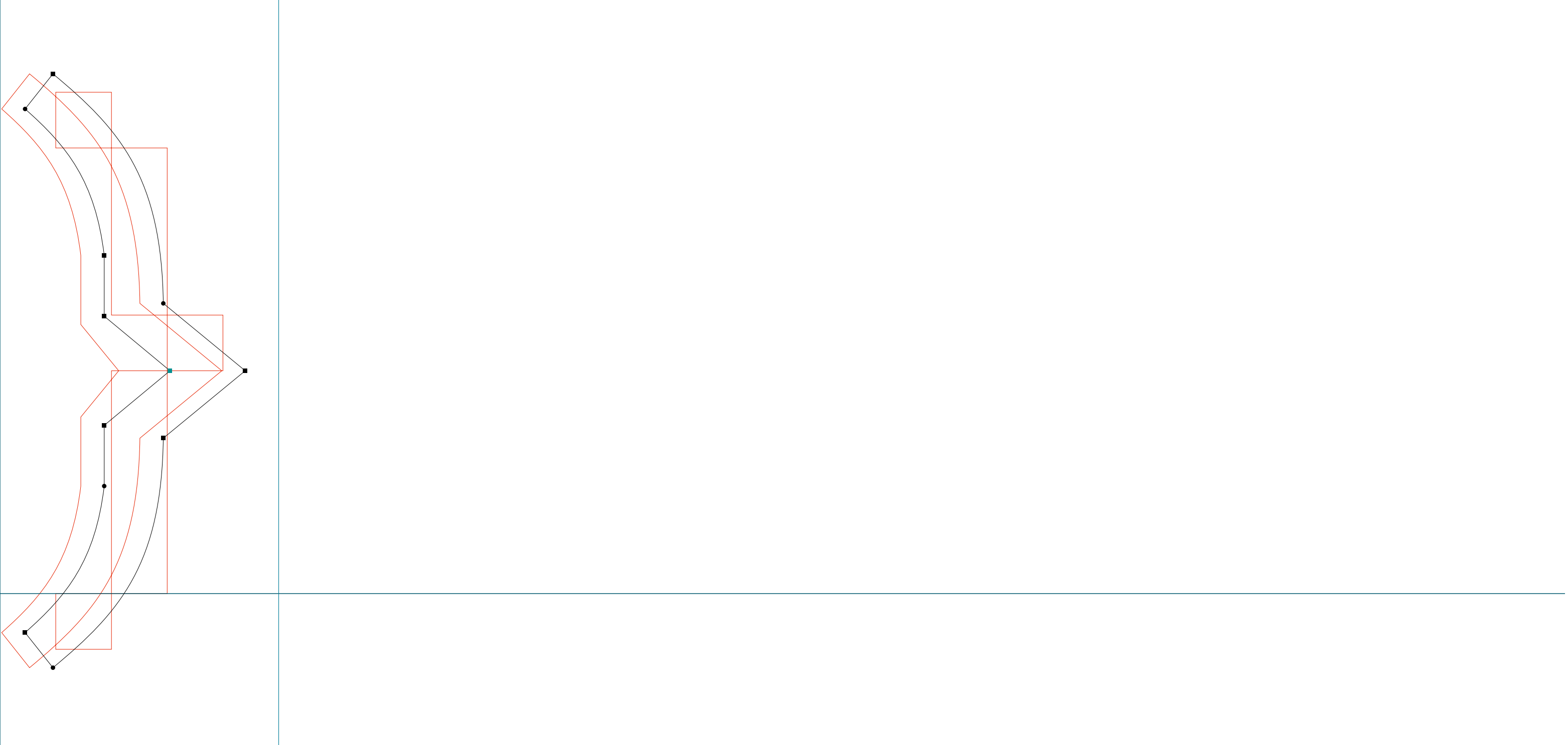

**BASE 9 & 12**

.....  
BaseTwelve Sans | asciitilde | RoboFog Sketches | 1995 | Emigre Fonts

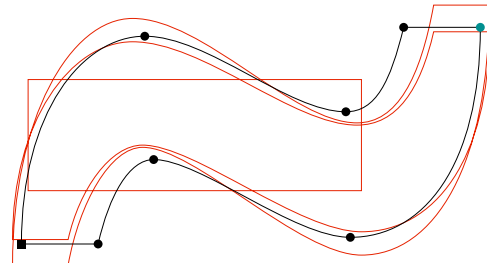



**BASE 9 & 12**

.....  
BaseTwelve Sans | dagger | RoboFog Sketches | 1995 | Emigre Fonts

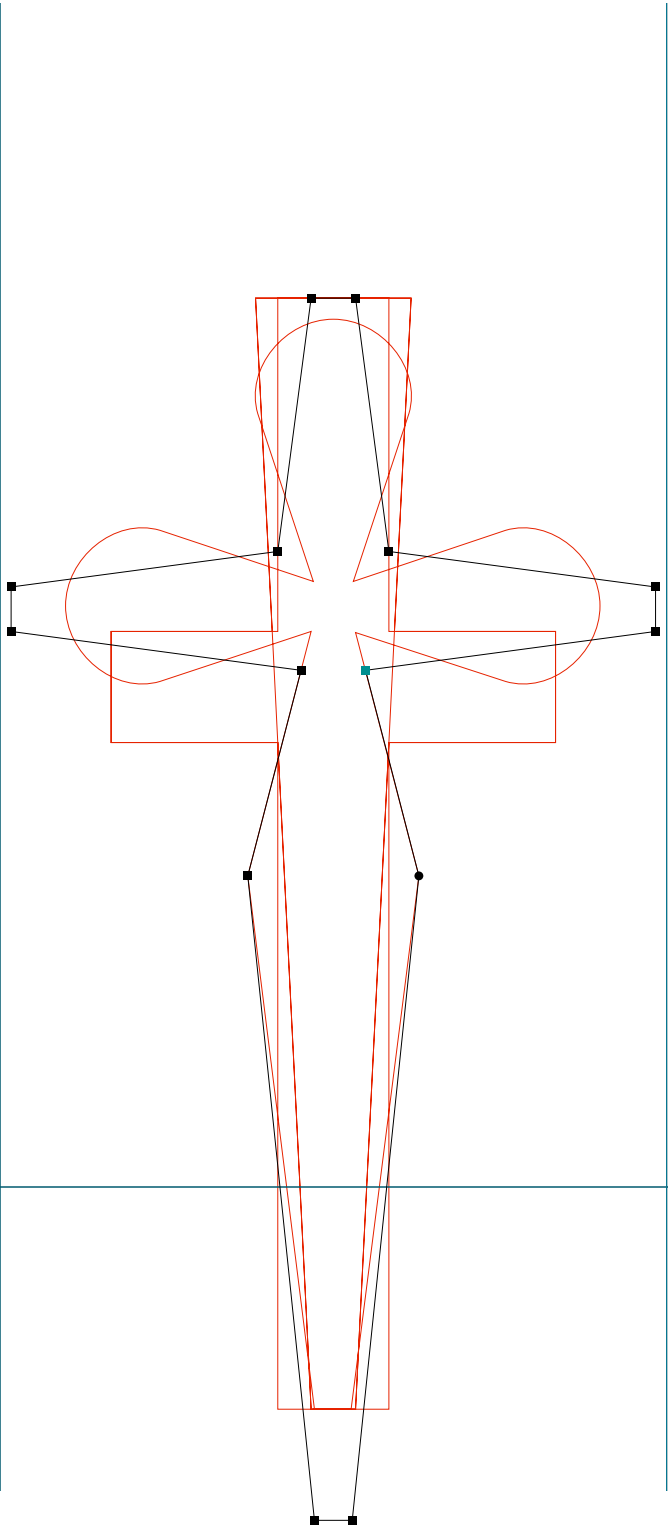

**BASE 9 & 12**

BaseTwelve Sans | degree | RoboFog Sketches | 1995 | Emigre Fonts

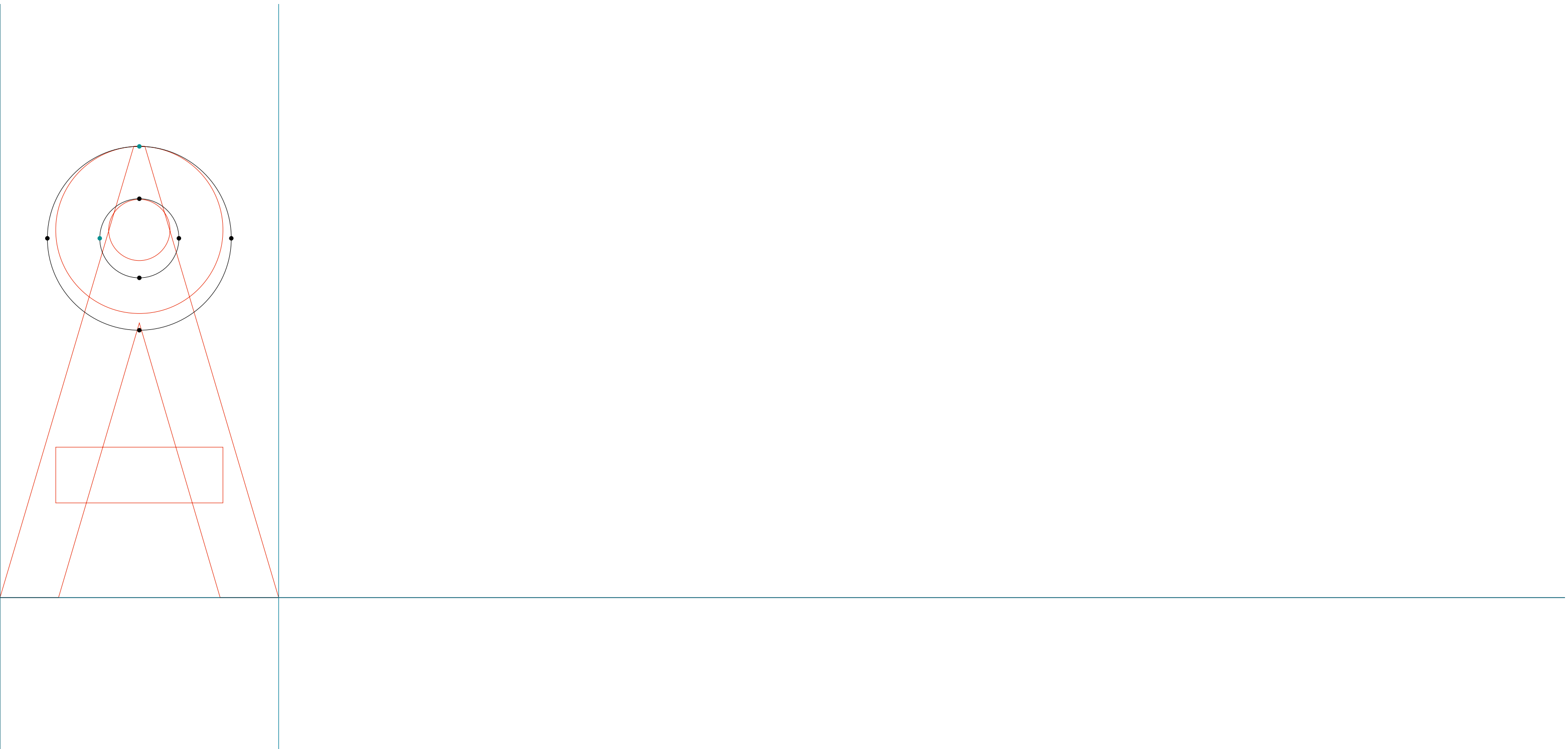

**BASE 9 & 12**

BaseTwelve Sans | cent | RoboFog Sketches | 1995 | Emigre Fonts

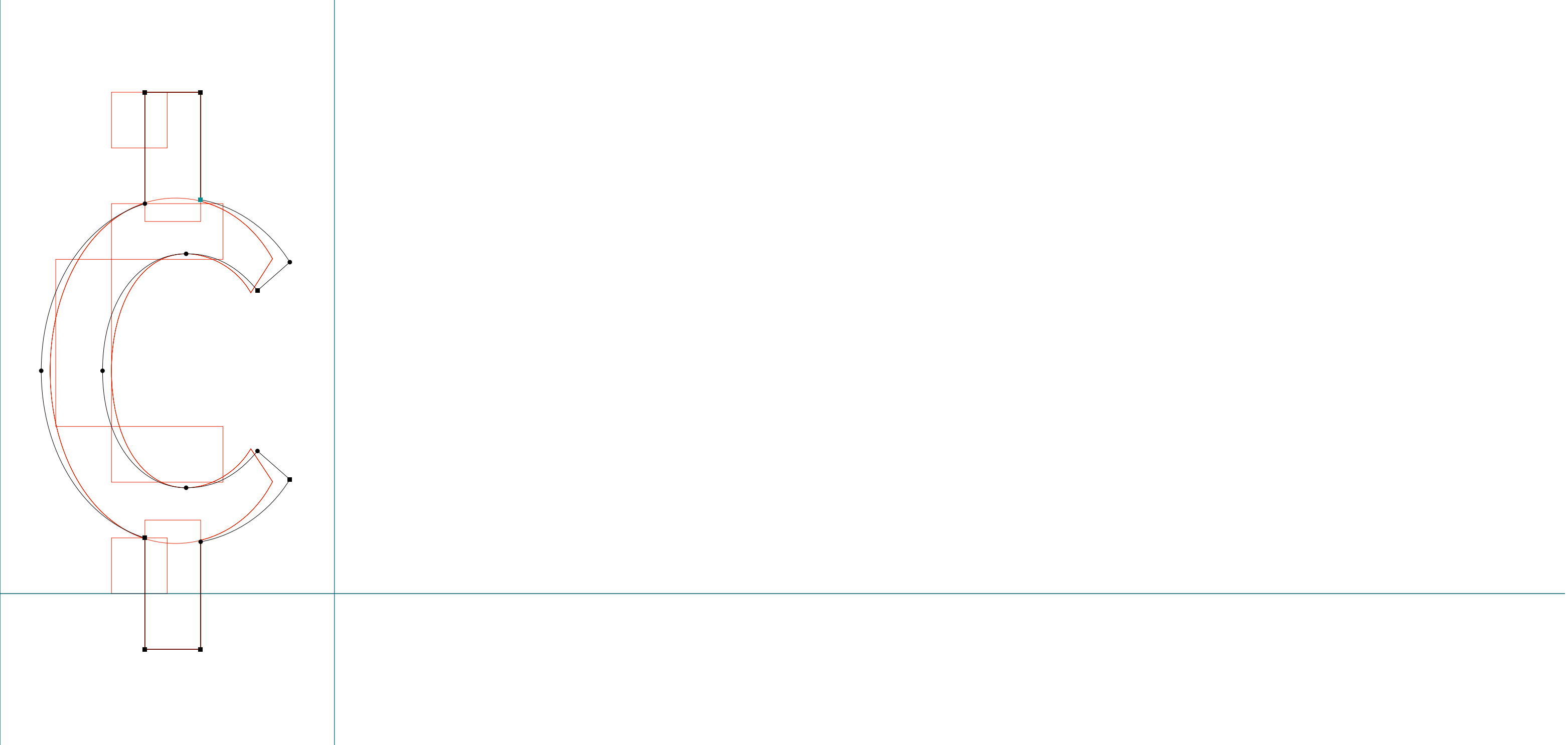

**BASE 9 & 12**

BaseTwelve Sans | section | RoboFog Sketches | 1995 | Emigre Fonts

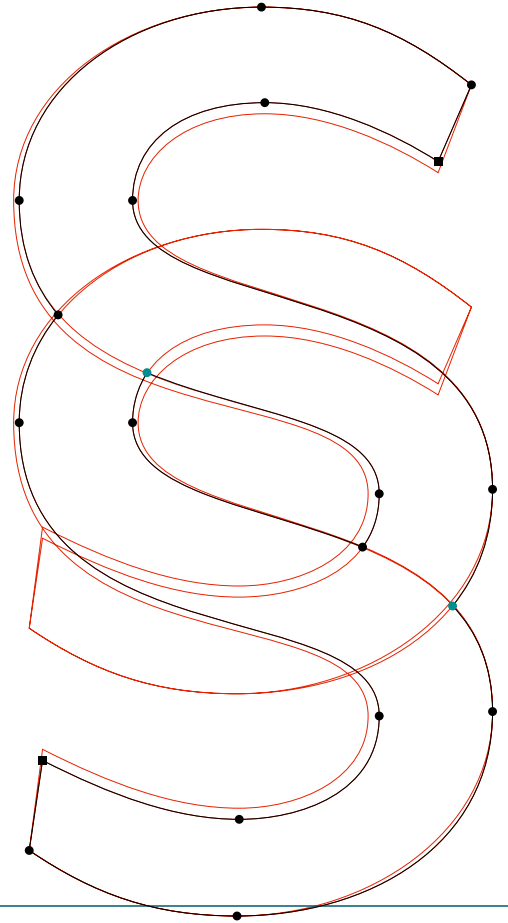

**BASE 9 & 12**

BaseTwelve Sans | bullet | RoboFog Sketches | 1995 | Emigre Fonts

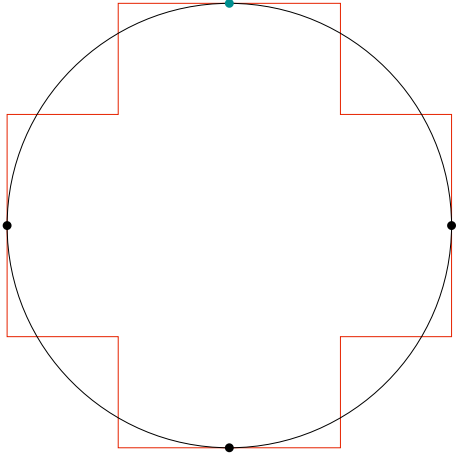

**BASE 9 & 12**

.....  
BaseTwelve Sans | registered | RoboFog Sketches | 1995 | Emigre Fonts

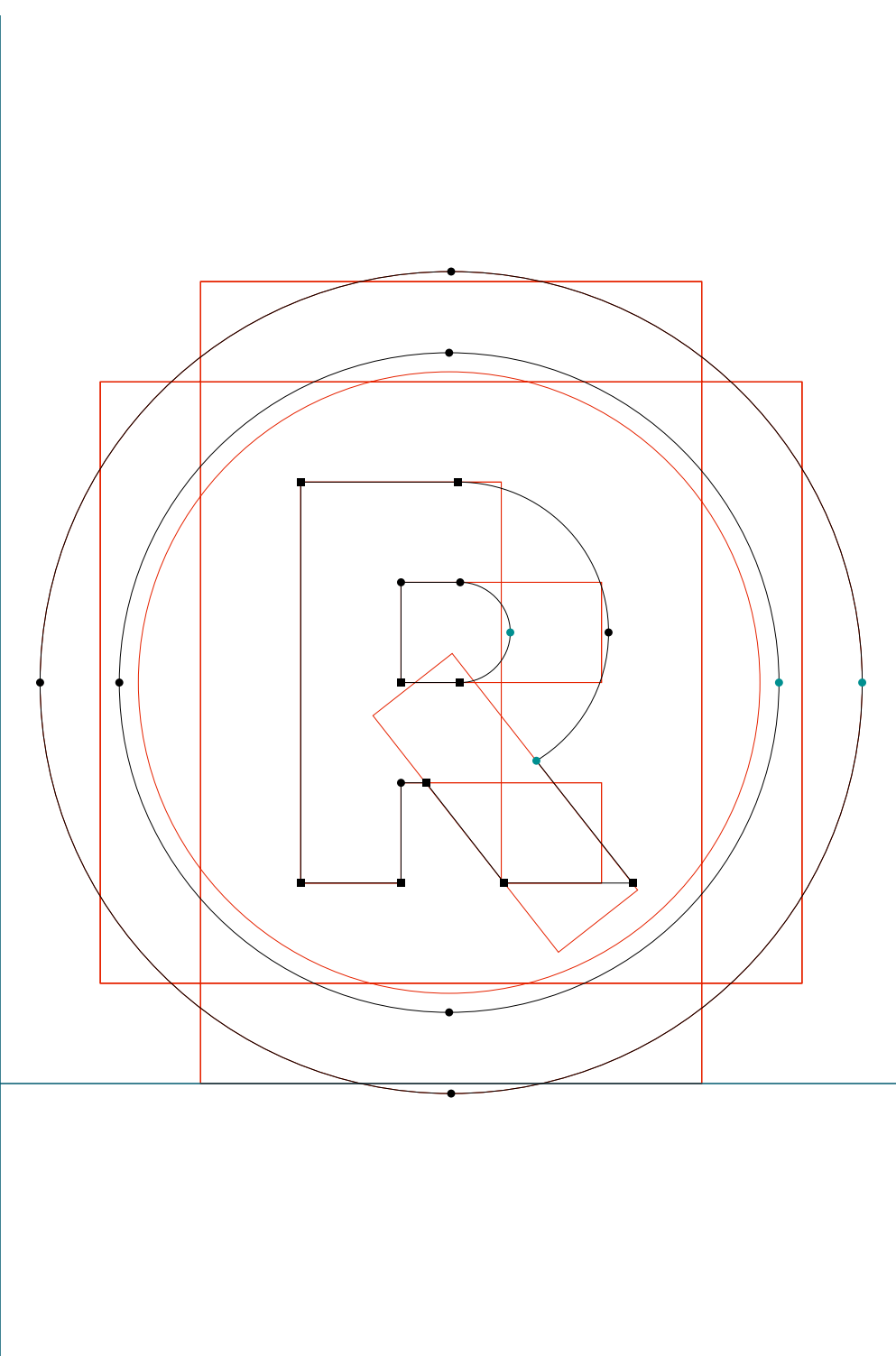

**BASE 9 & 12**

.....  
BaseTwelve Sans | copyright | RoboFog Sketches | 1995 | Emigre Fonts

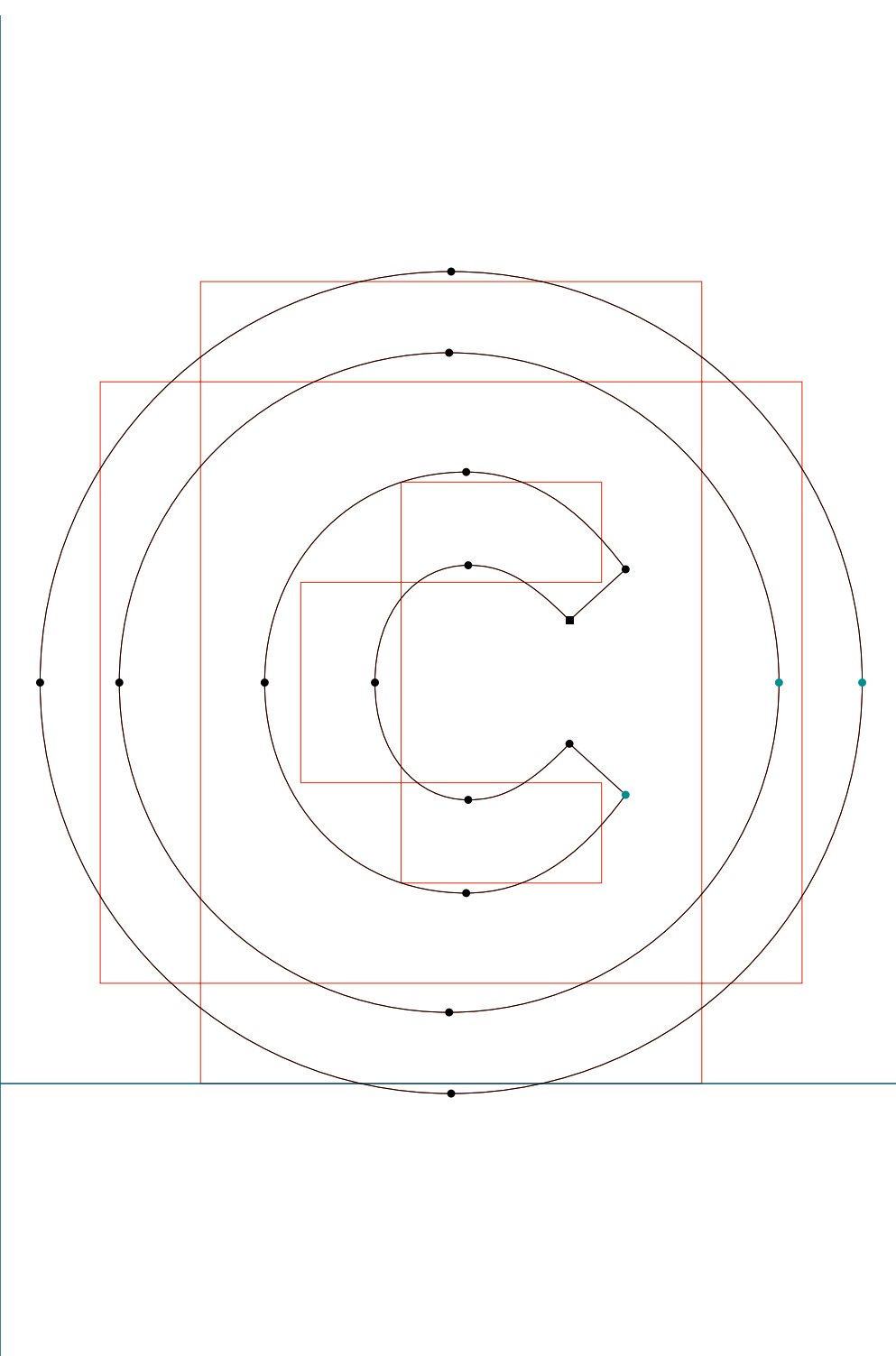

**BASE 9 & 12**

BaseTwelve Sans | yen | RoboFog Sketches | 1995 | Emigre Fonts

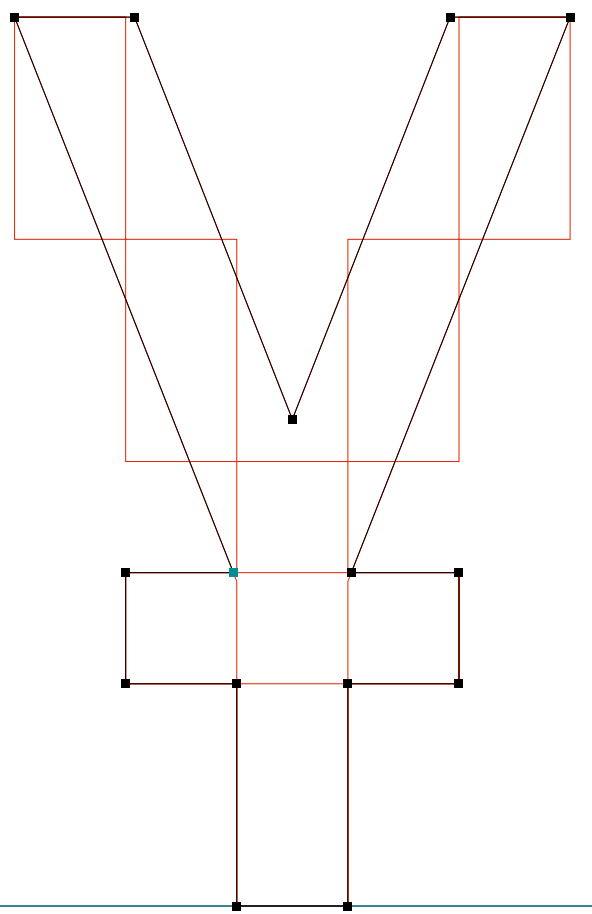



**BASE 9 & 12**

.....  
BaseTwelve Sans | approxequal | RoboFog Sketches | 1995 | Emigre Fonts

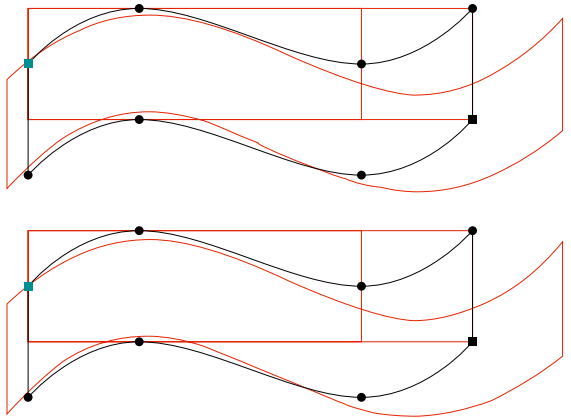

**BASE 9 & 12**

.....  
BaseTwelve Sans | lozenge | RoboFog Sketches | 1995 | Emigre Fonts

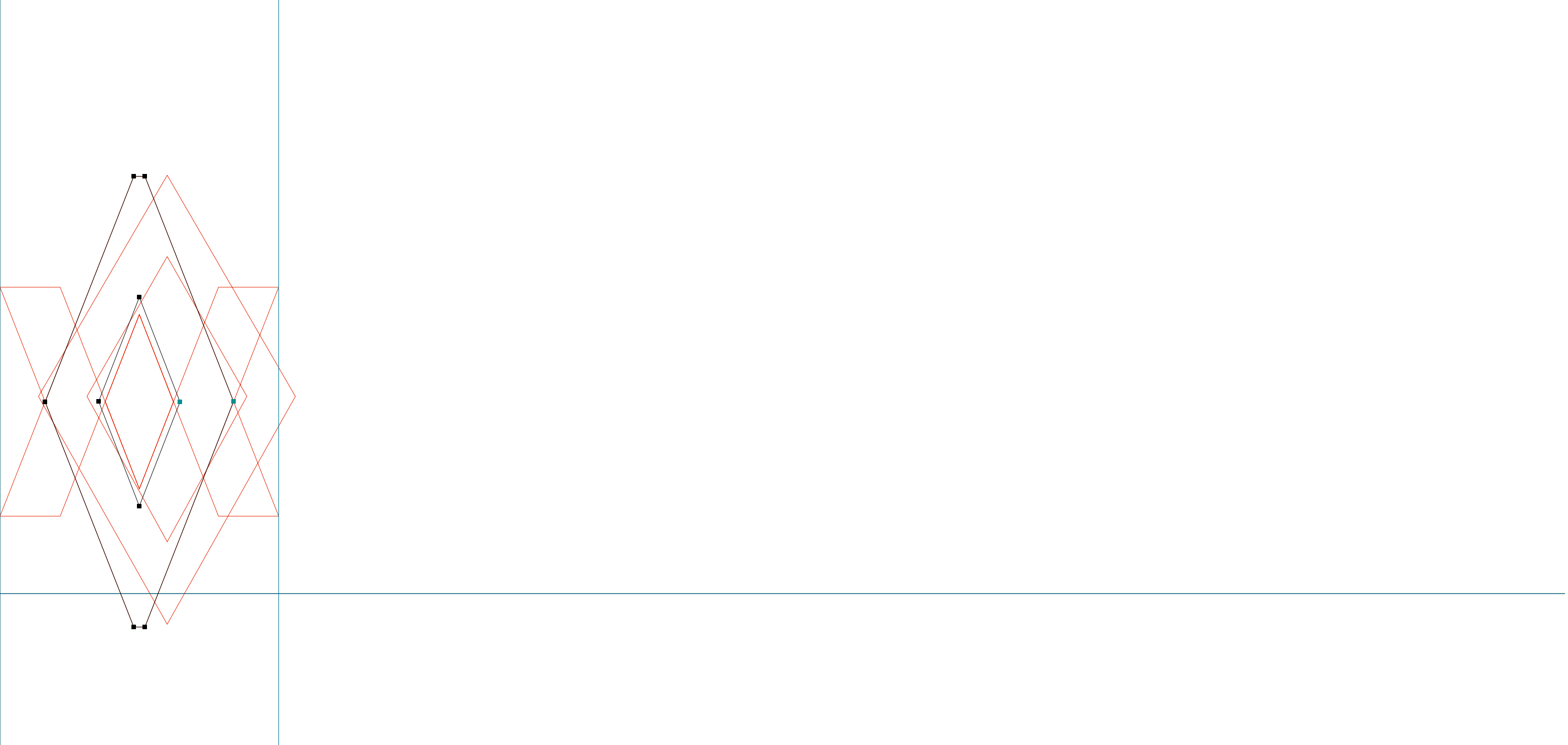

**BASE 9 & 12**

.....  
BaseTwelve Sans | circumflex | RoboFog Sketches | 1995 | Emigre Fonts

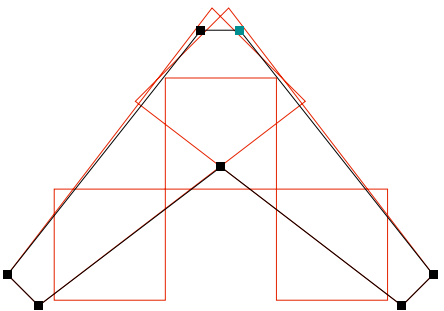

**BASE 9 & 12**

.....  
BaseTwelve Sans | ring | RoboFog Sketches | 1995 | Emigre Fonts

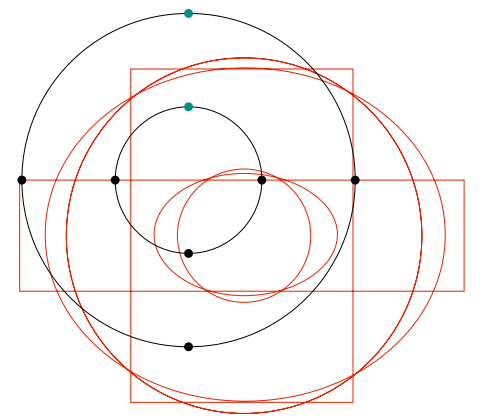

**BASE 9 & 12**

BaseTwelve Sans | cedilla | RoboFog Sketches | 1995 | Emigre Fonts

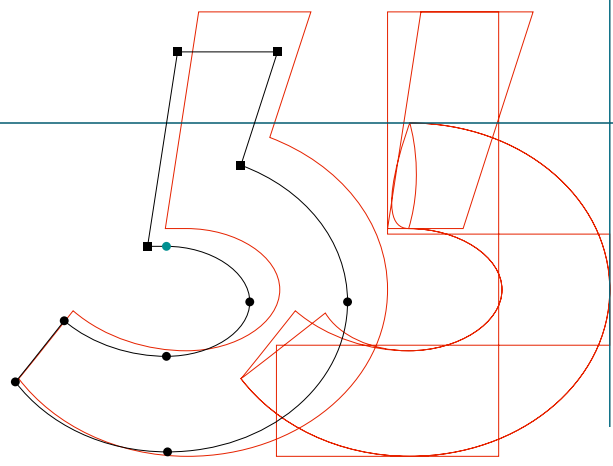

**BASE 9 & 12**

BaseTwelve SansSmallcaps | dollar | RoboFog Sketches | 1995 | Emigre Fonts

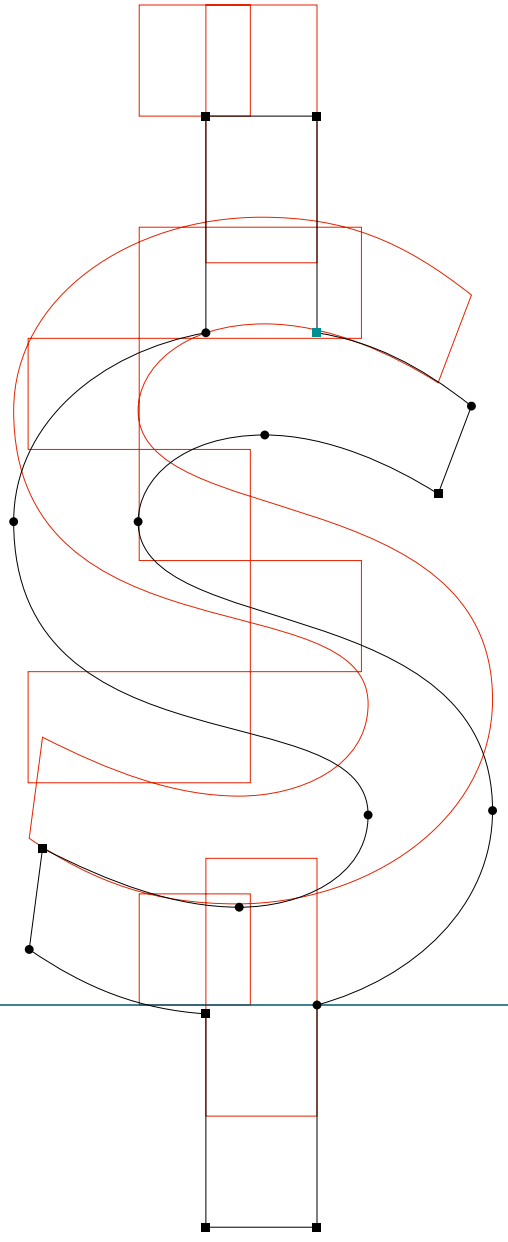

**BASE 9 & 12**

.....  
BaseTwelve SansSmallcaps | ampersand | RoboFog Sketches | 1995 | Emigre Fonts

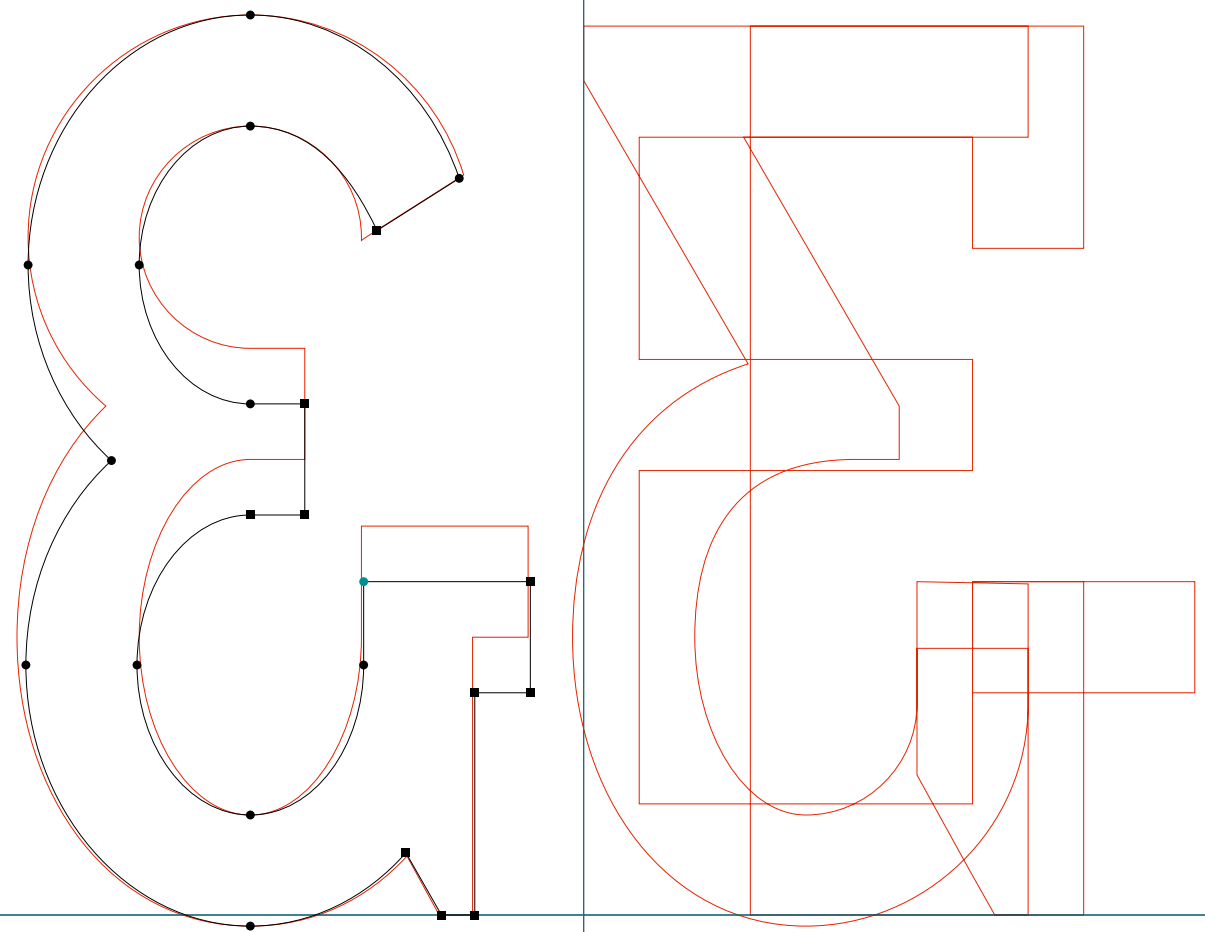

**BASE 9 & 12**

.....  
BaseTwelve SansSmallcaps | asterisk | RoboFog Sketches | 1995 | Emigre Fonts

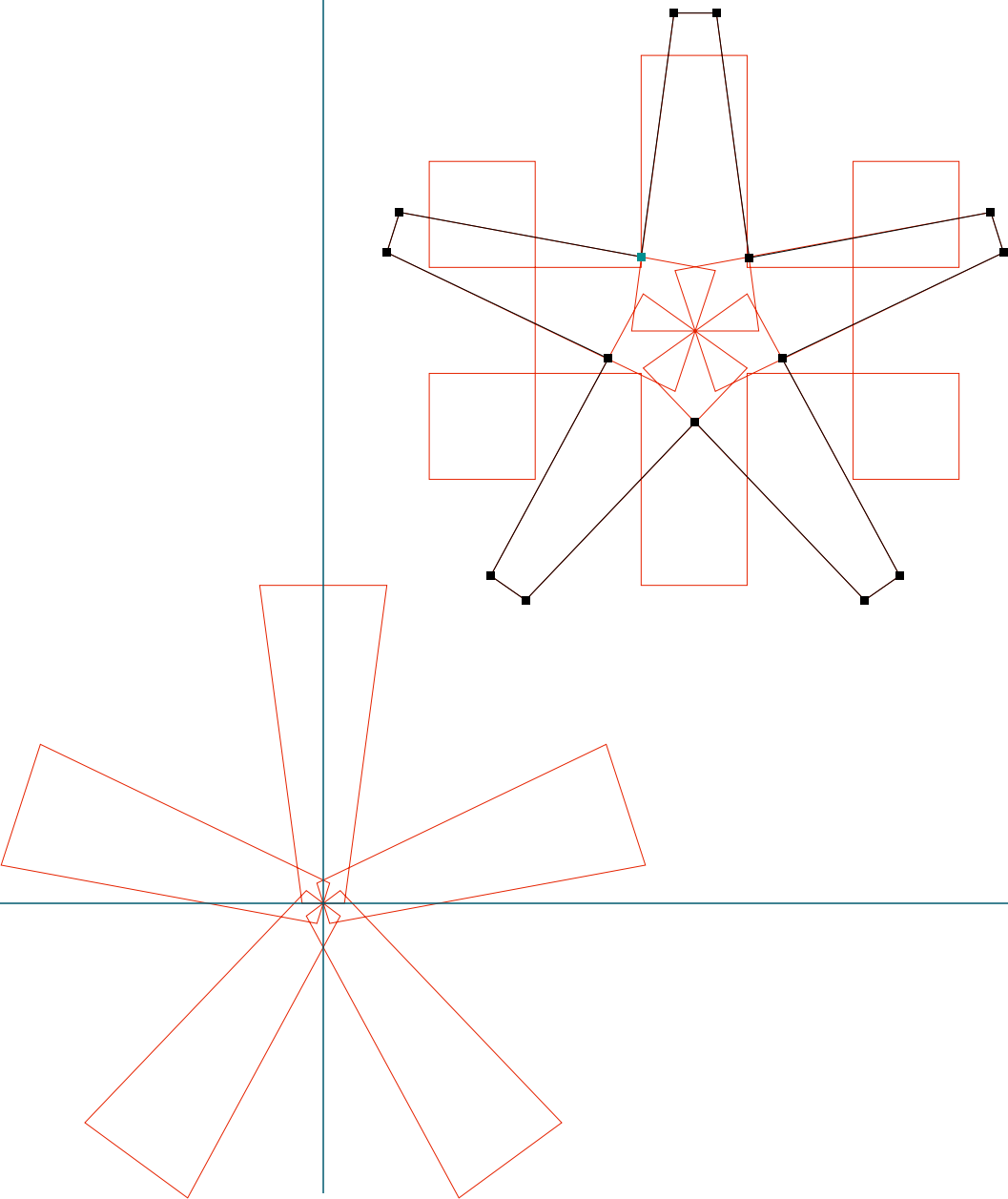



**BASE 9 & 12**

.....  
BaseTwelve SansSmallcaps | comma | RoboFog Sketches | 1995 | Emigre Fonts

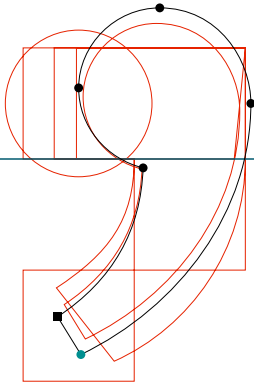

**BASE 9 & 12**

.....  
BaseTwelve SansSmallcaps | period | RoboFog Sketches | 1995 | Emigre Fonts

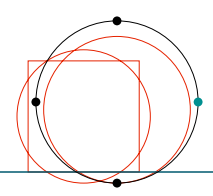

**BASE 9 & 12**

.....  
BaseTwelve SansSmallcaps | slash | RoboFog Sketches | 1995 | Emigre Fonts

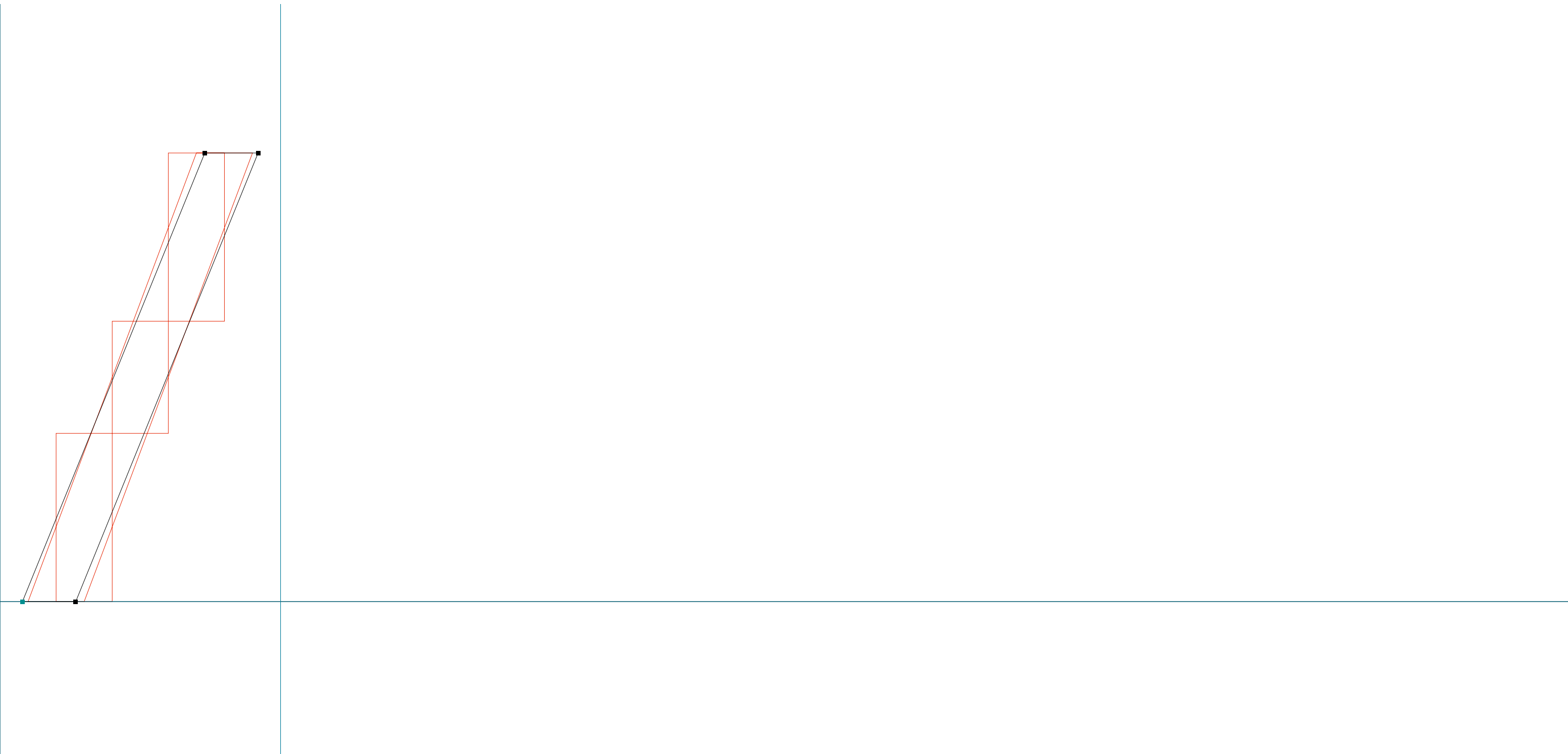

**BASE 9 & 12**

.....  
BaseTwelve SansSmallcaps | one | RoboFog Sketches | 1995 | Emigre Fonts

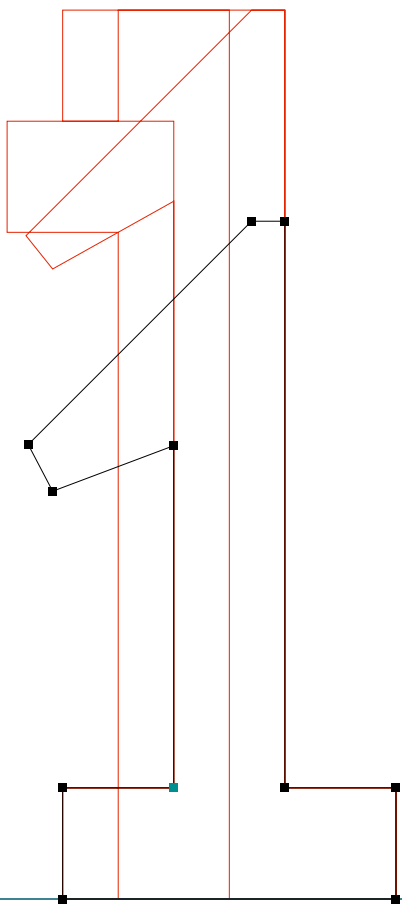

**BASE 9 & 12**

.....  
BaseTwelve SansSmallcaps | two | RoboFog Sketches | 1995 | Emigre Fonts

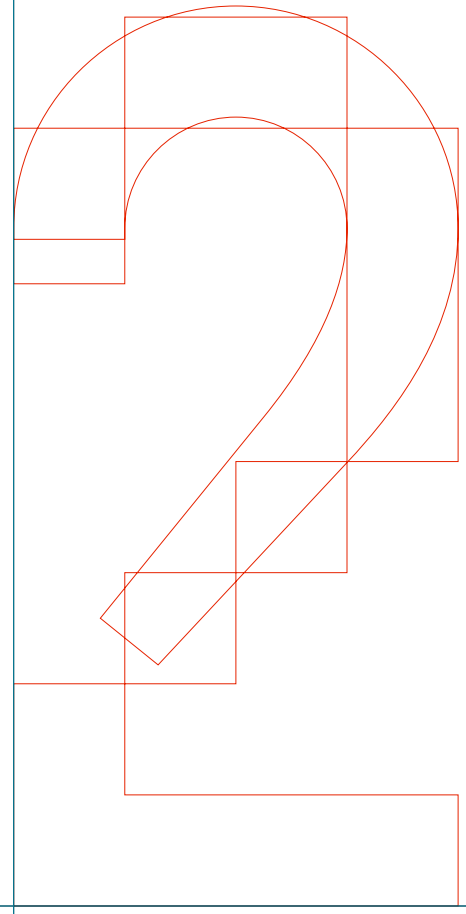
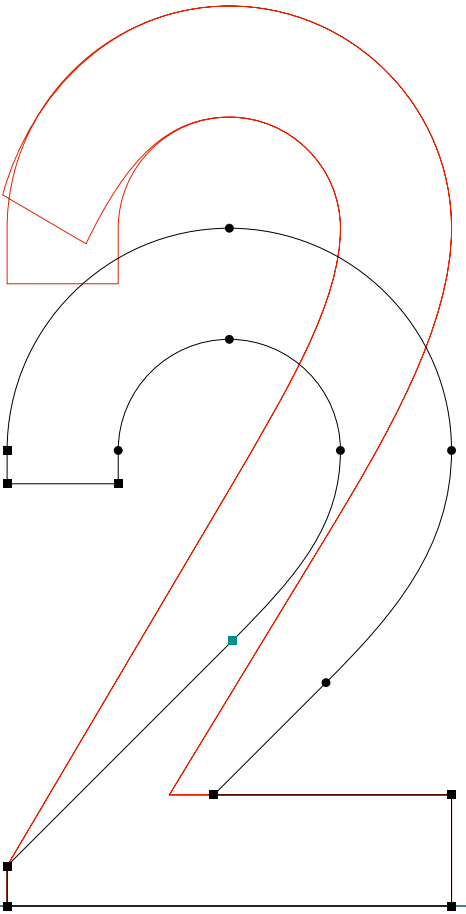

**BASE 9 & 12**

.....  
BaseTwelve SansSmallcaps | three | RoboFog Sketches | 1995 | Emigre Fonts

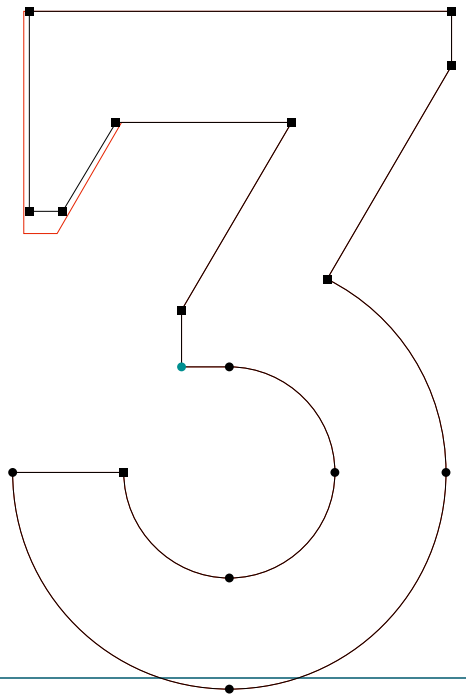
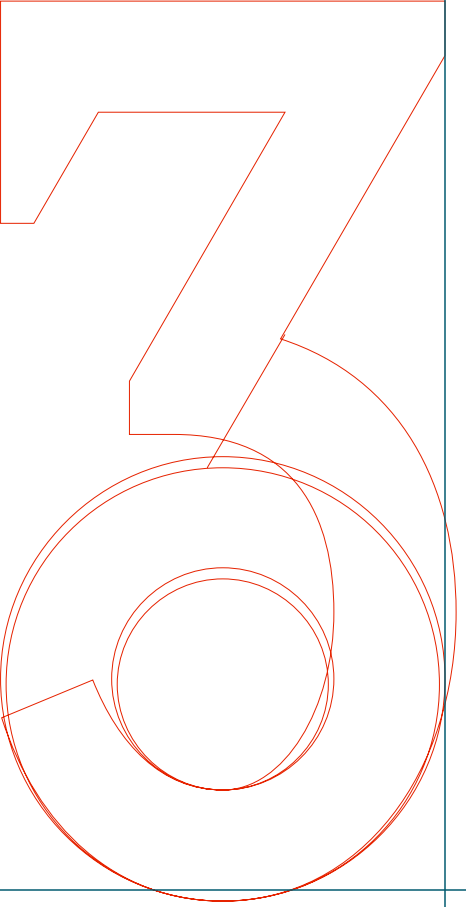

**BASE 9 & 12**

.....  
BaseTwelve SansSmallcaps | five | RoboFog Sketches | 1995 | Emigre Fonts

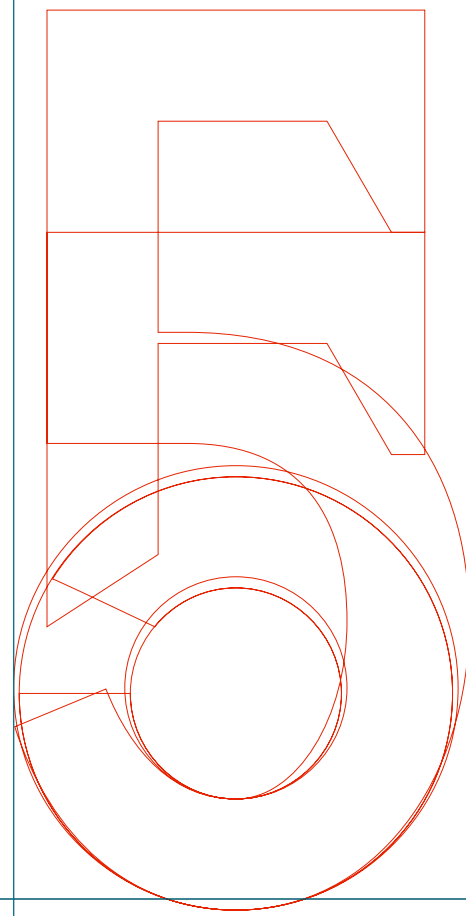
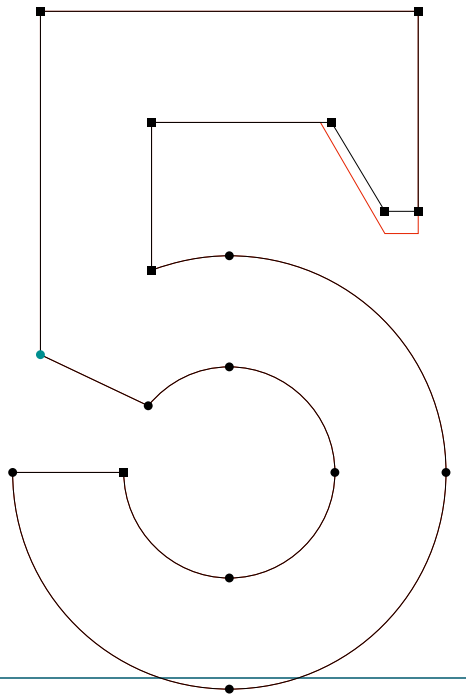

**BASE 9 & 12**

BaseTwelve SansSmallcaps | six | RoboFog Sketches | 1995 | Emigre Fonts

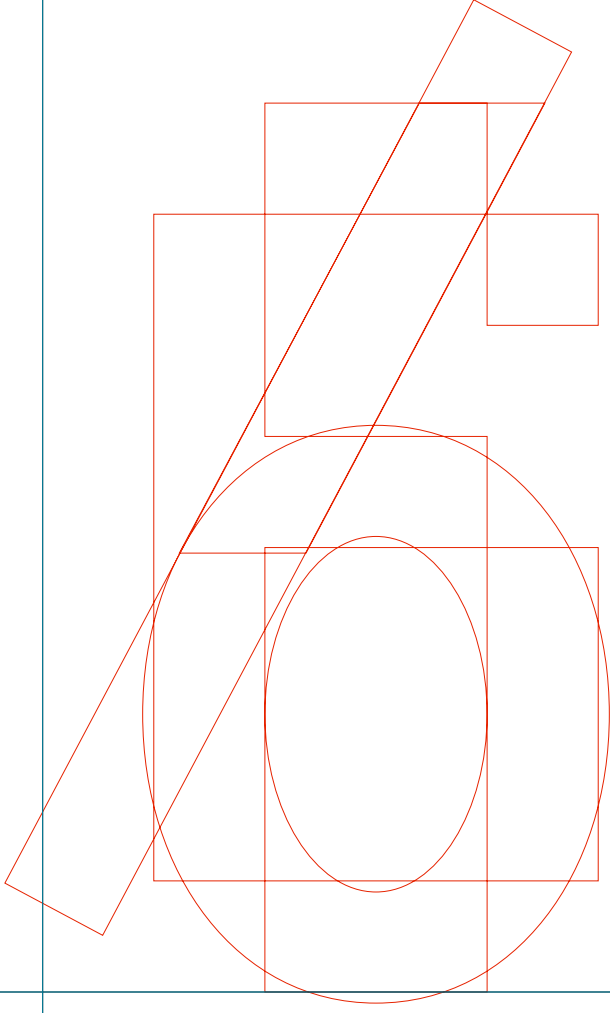
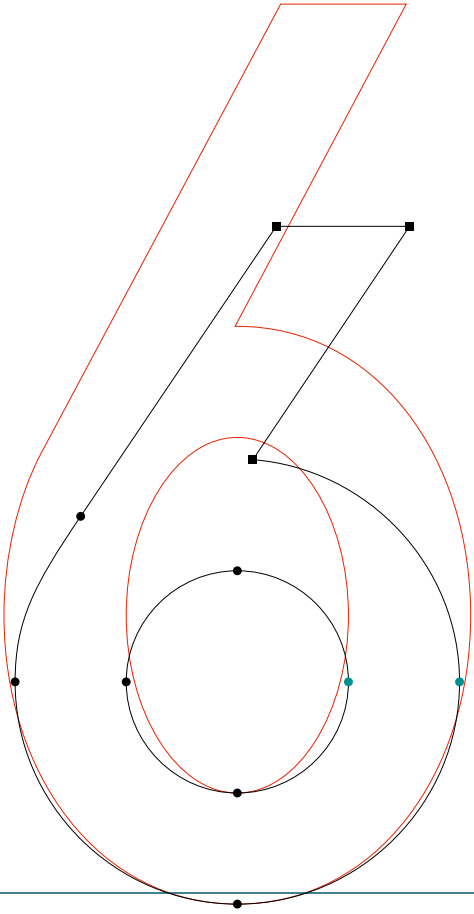



**BASE 9 & 12**

.....  
BaseTwelve SansSmallcaps | eight | RoboFog Sketches | 1995 | Emigre Fonts

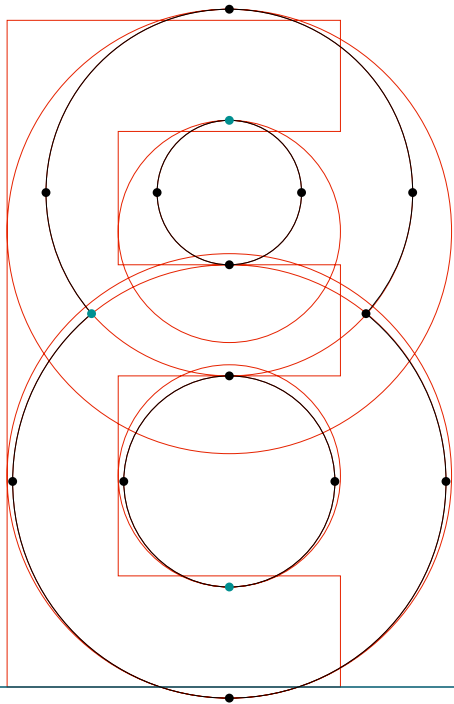

**BASE 9 & 12**

.....  
BaseTwelve SansSmallcaps | nine | RoboFog Sketches | 1995 | Emigre Fonts

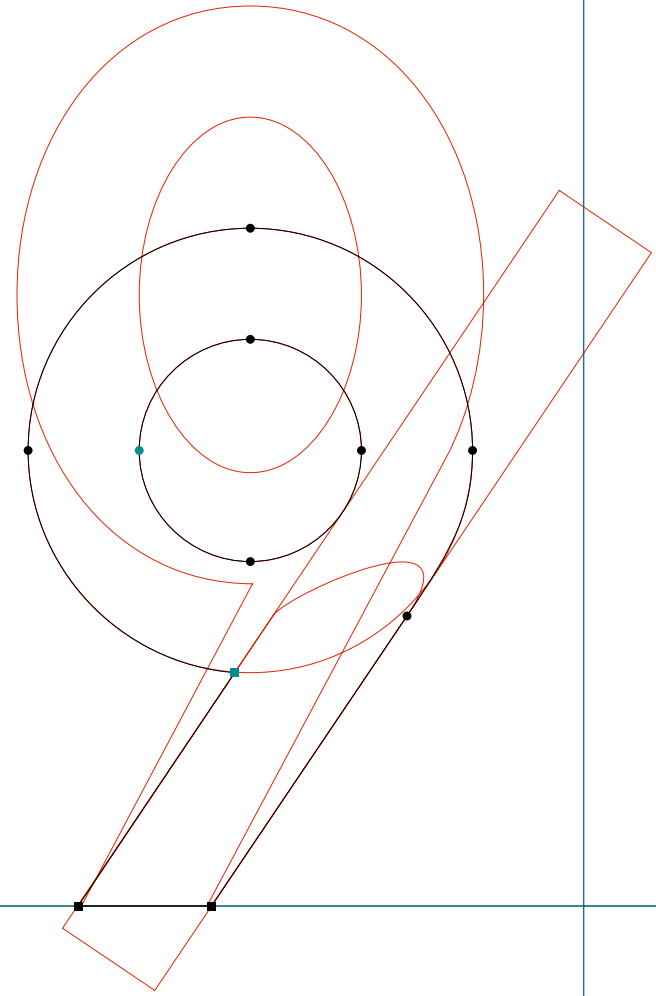

**BASE 9 & 12**

BaseTwelve SansSmallcaps | question | RoboFog Sketches | 1995 | Emigre Fonts

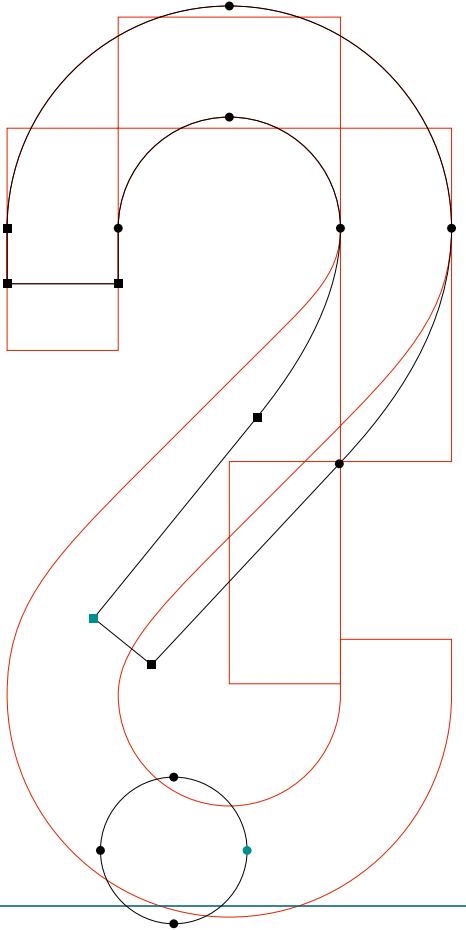

**BASE 9 & 12**

.....  
BaseTwelve SansSmallcaps | A | RoboFog Sketches | 1995 | Emigre Fonts

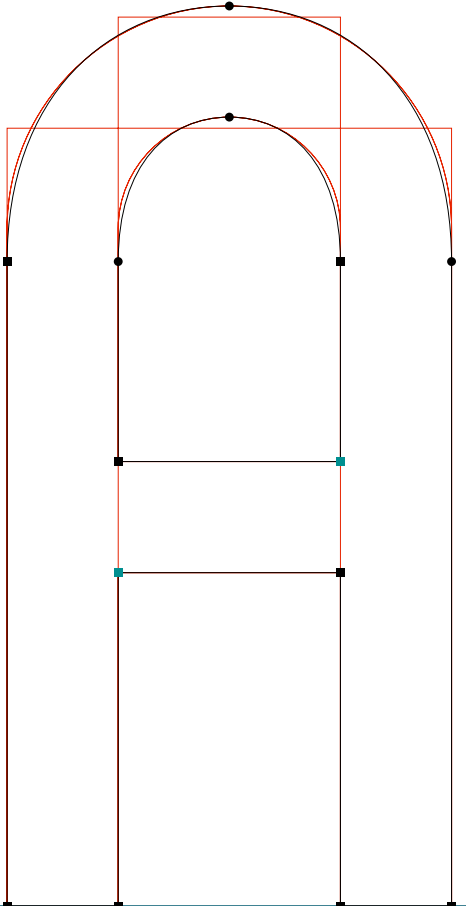

**BASE 9 & 12**

.....  
BaseTwelve SansSmallcaps | B | RoboFog Sketches | 1995 | Emigre Fonts

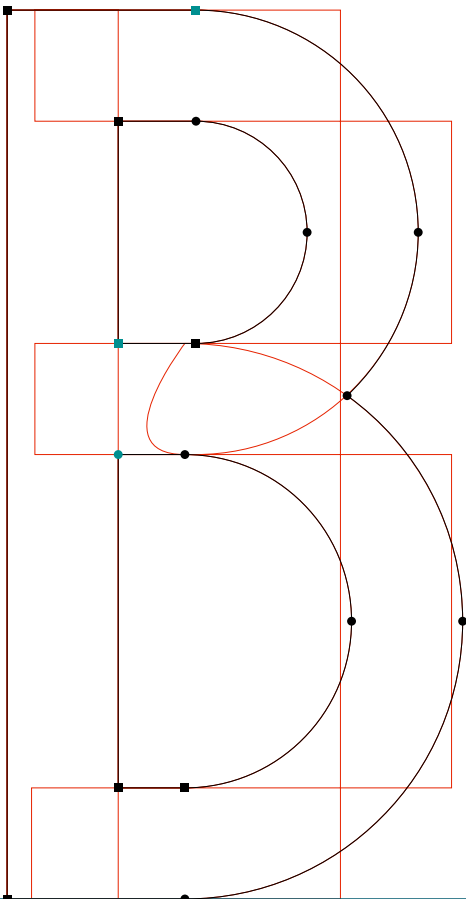

**BASE 9 & 12**

.....  
BaseTwelve SansSmallcaps | D | RoboFog Sketches | 1995 | Emigre Fonts

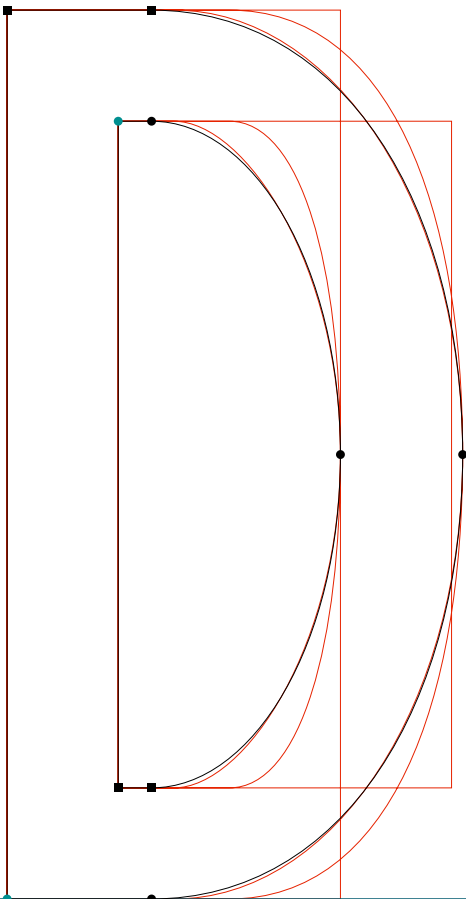

**BASE 9 & 12**

.....  
BaseTwelve SansSmallcaps | G | RoboFog Sketches | 1995 | Emigre Fonts

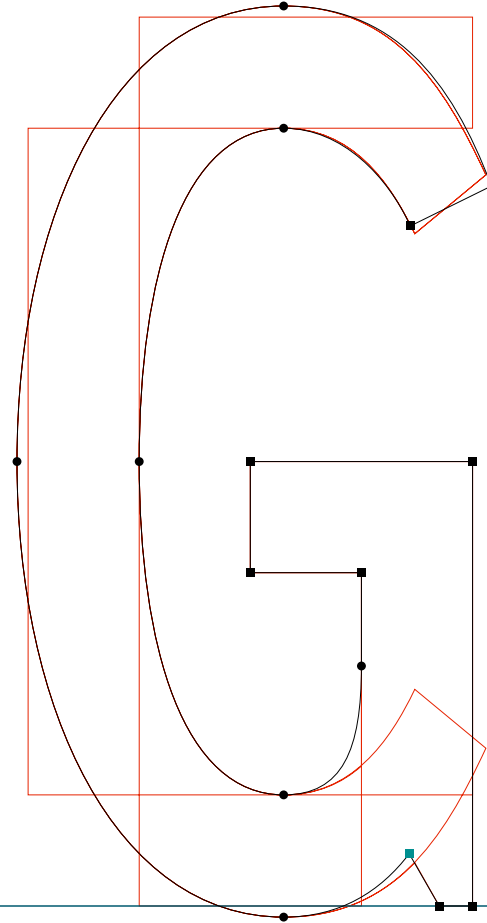

**BASE 9 & 12**

.....  
BaseTwelve SansSmallcaps | K | RoboFog Sketches | 1995 | Emigre Fonts

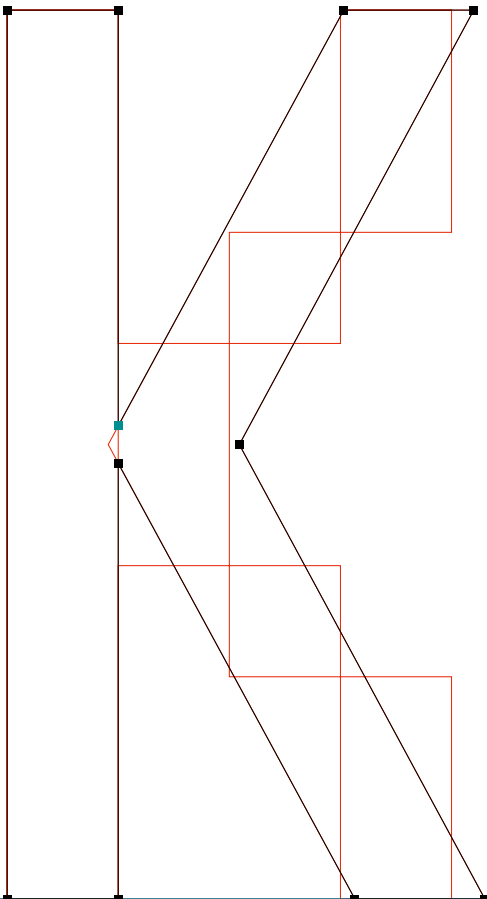



**BASE 9 & 12**

.....  
BaseTwelve SansSmallcaps | M | RoboFog Sketches | 1995 | Emigre Fonts

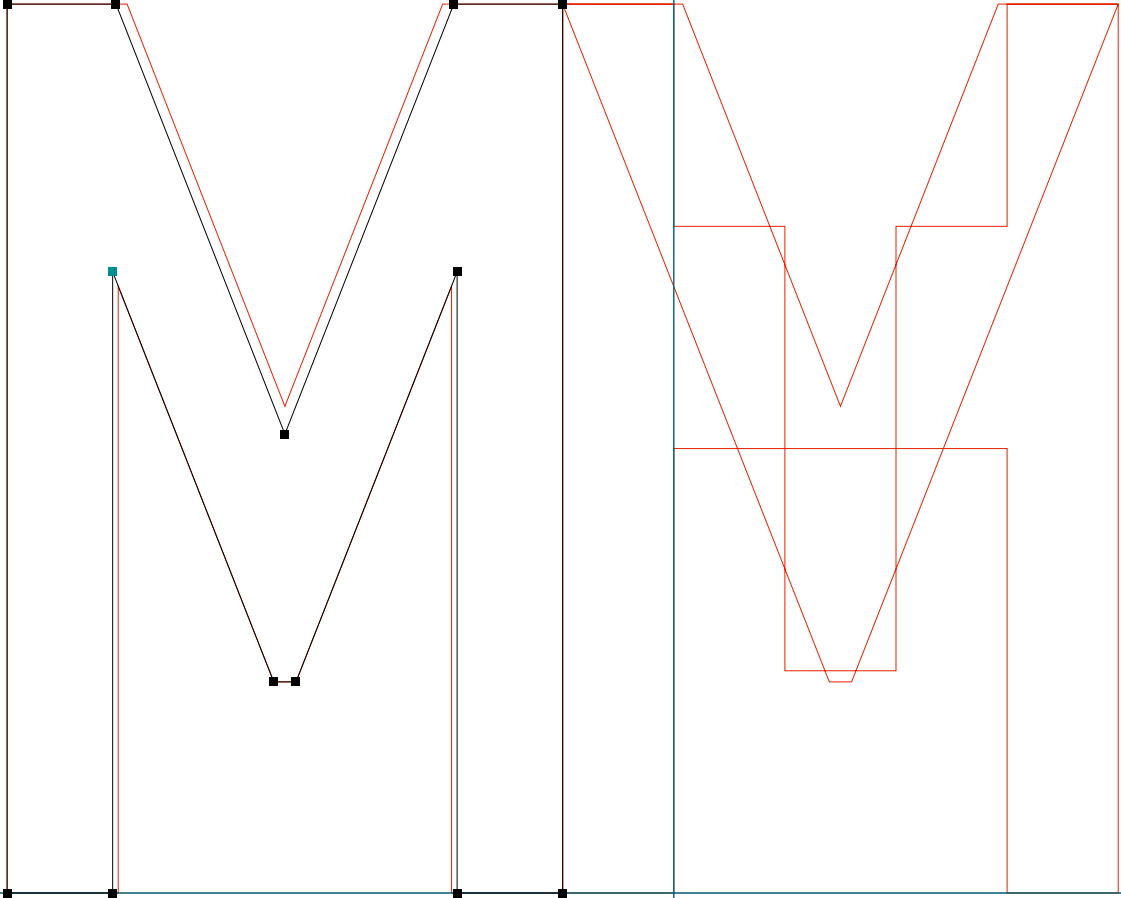

**BASE 9 & 12**

.....  
BaseTwelve SansSmallcaps | N | RoboFog Sketches | 1995 | Emigre Fonts

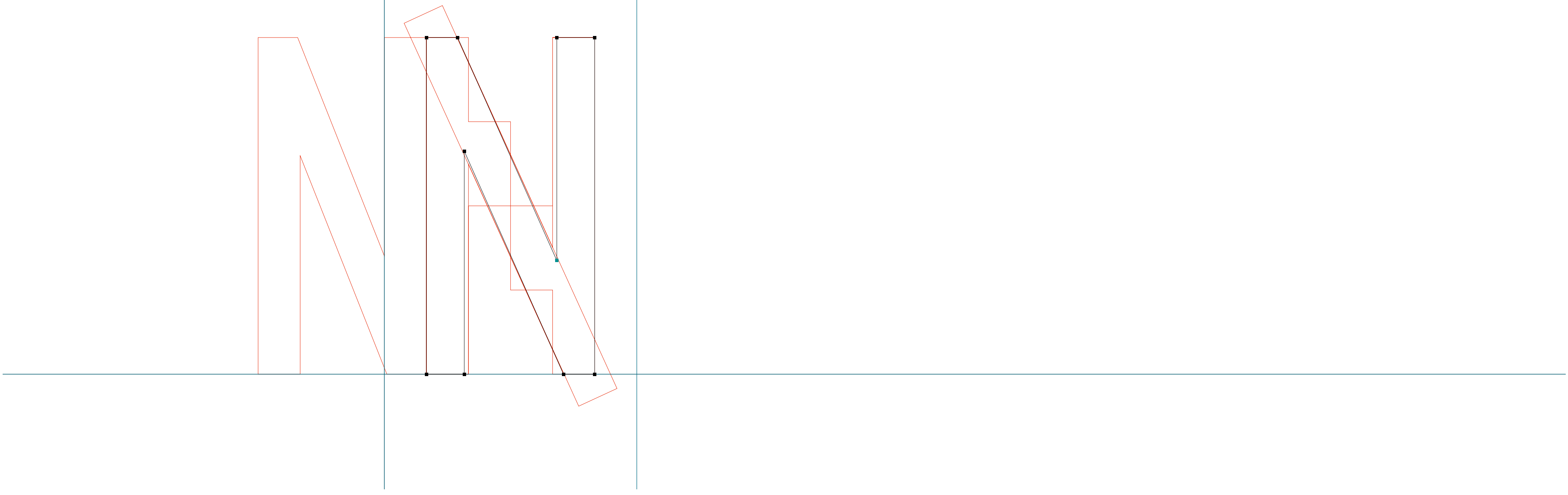

**BASE 9 & 12**

.....  
BaseTwelve SansSmallcaps | 0 | RoboFog Sketches | 1995 | Emigre Fonts

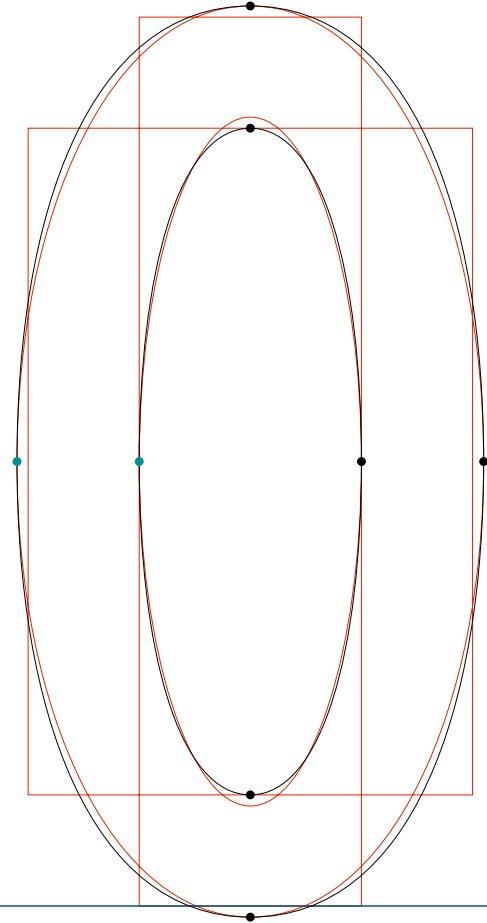

**BASE 9 & 12**

.....  
BaseTwelve SansSmallcaps | P | RoboFog Sketches | 1995 | Emigre Fonts

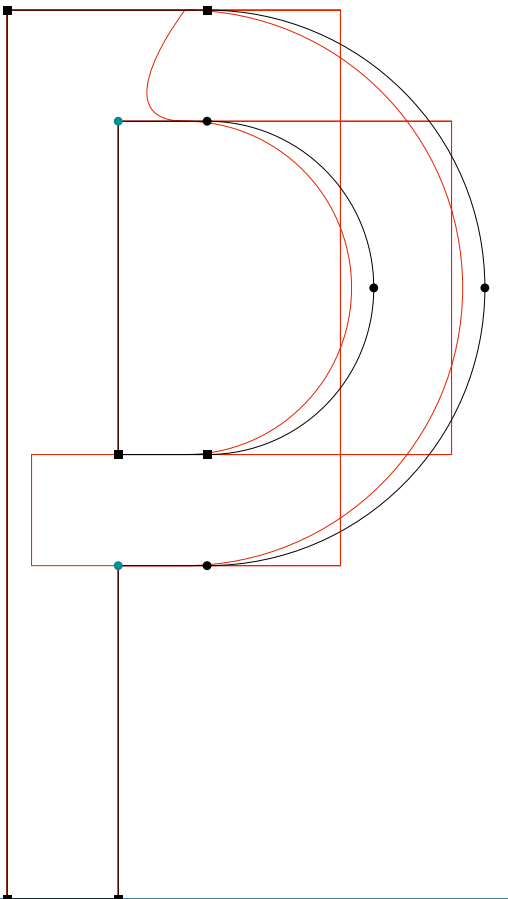

**BASE 9 & 12**

.....  
BaseTwelve SansSmallcaps | Q | RoboFog Sketches | 1995 | Emigre Fonts

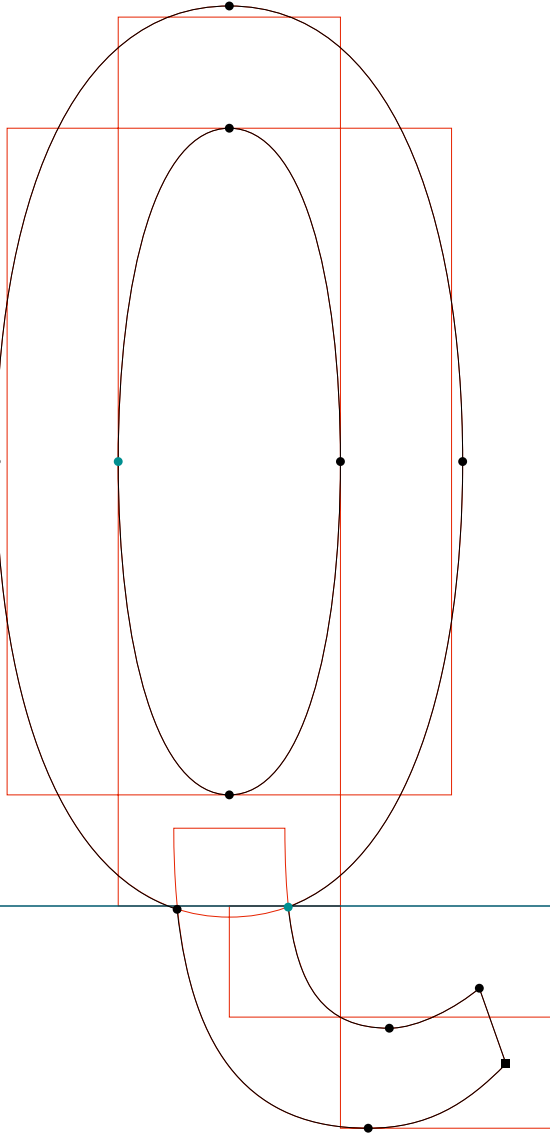

**BASE 9 & 12**

.....  
BaseTwelve SansSmallcaps | R | RoboFog Sketches | 1995 | Emigre Fonts

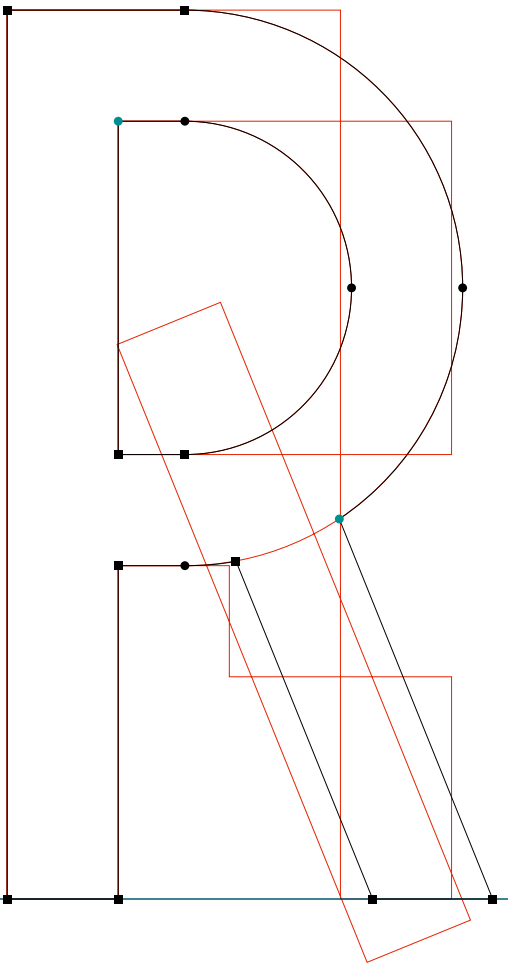

**BASE 9 & 12**

.....  
BaseTwelve SansSmallcaps | U | RoboFog Sketches | 1995 | Emigre Fonts

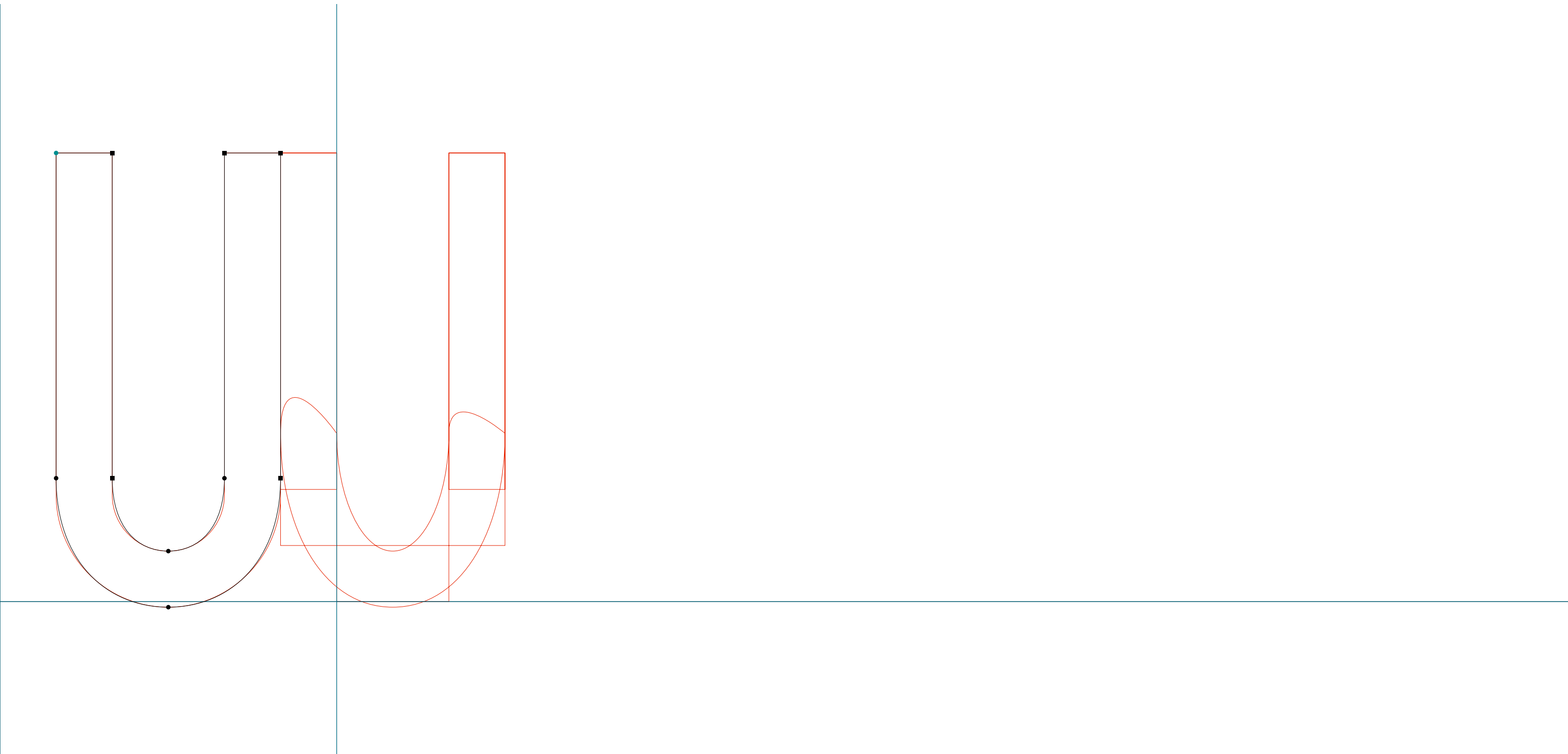

**BASE 9 & 12**

.....  
BaseTwelve SansSmallcaps | V | RoboFog Sketches | 1995 | Emigre Fonts

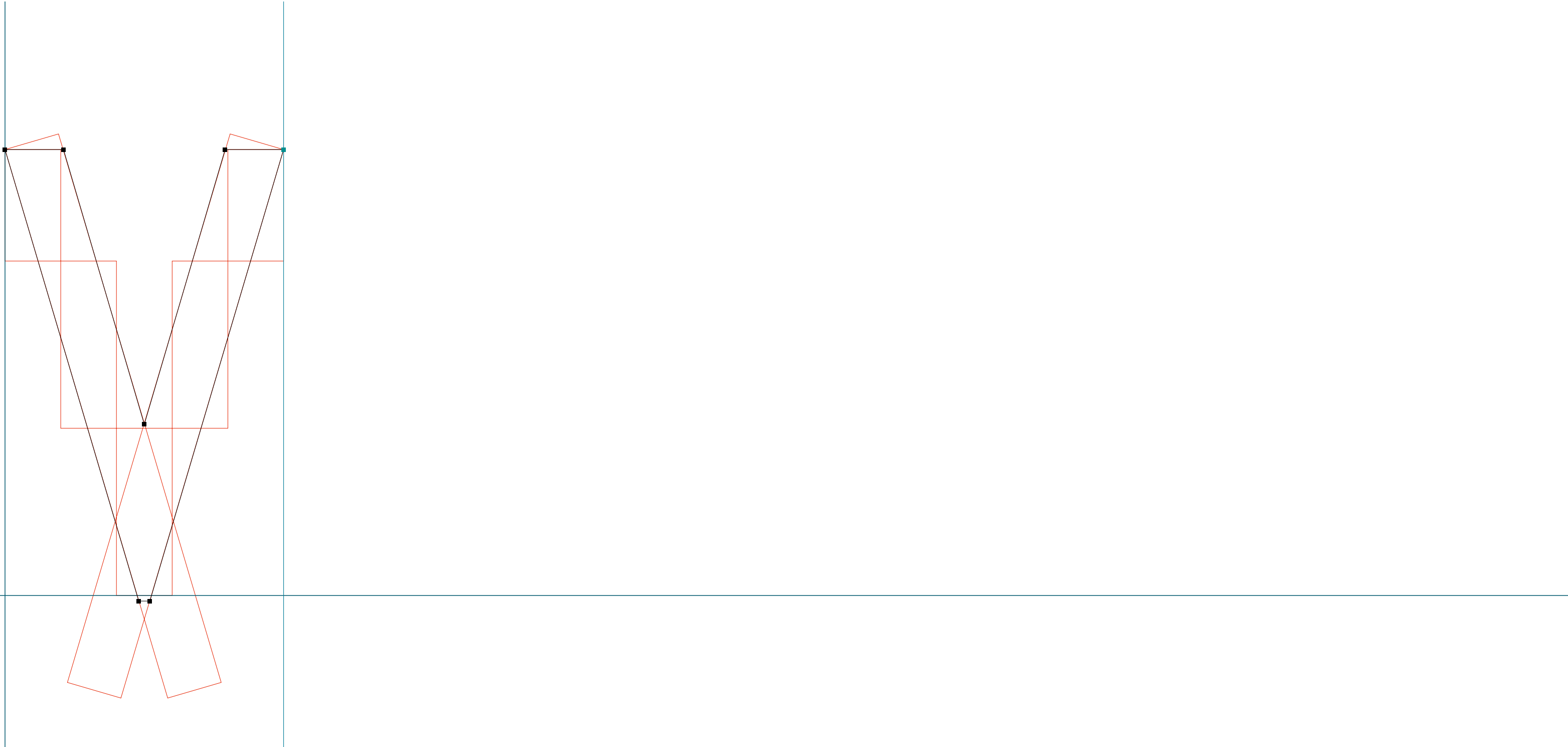



**BASE 9 & 12**

.....  
BaseTwelve SansSmallcaps | W | RoboFog Sketches | 1995 | Emigre Fonts

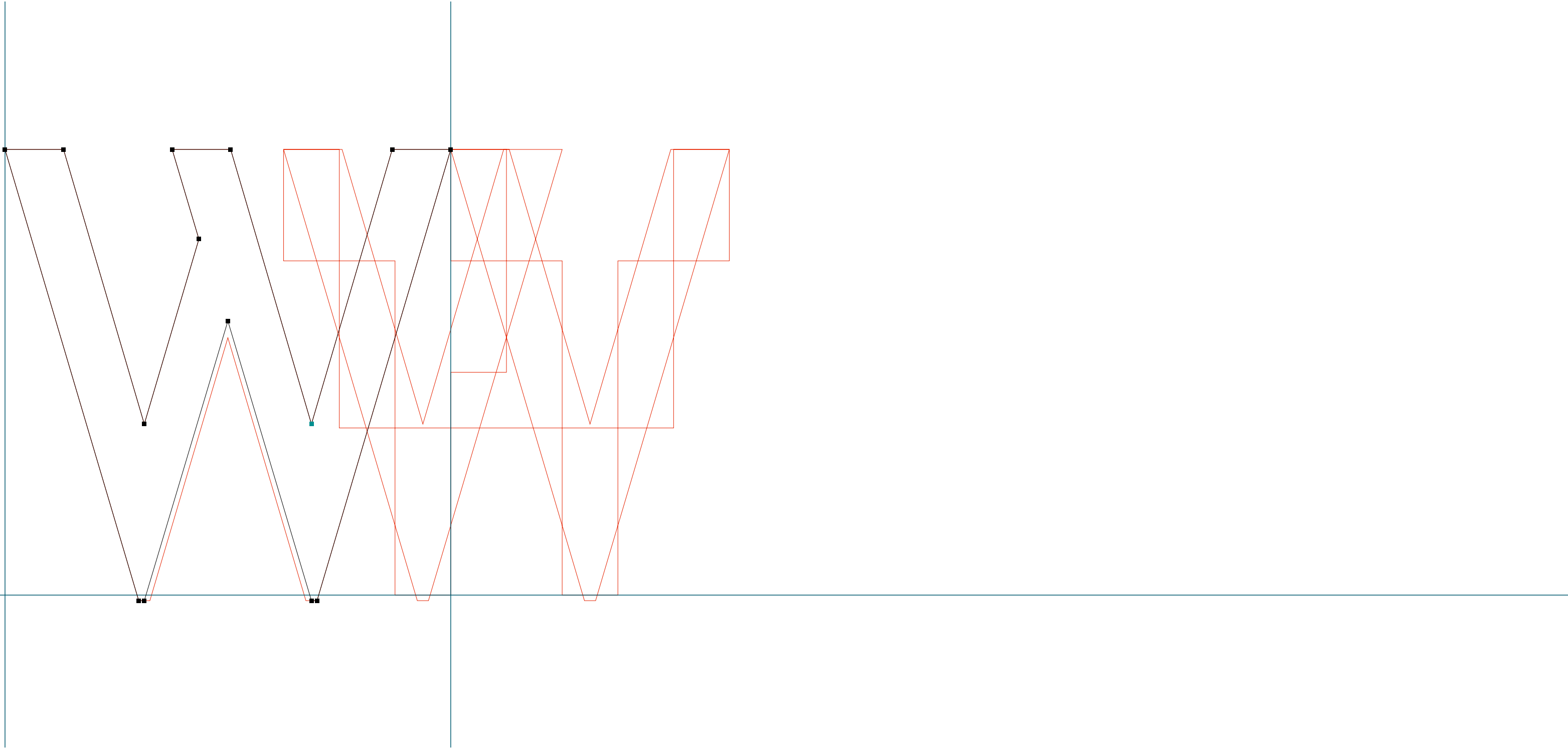

**BASE 9 & 12**

.....  
BaseTwelve SansSmallcaps | Y | RoboFog Sketches | 1995 | Emigre Fonts

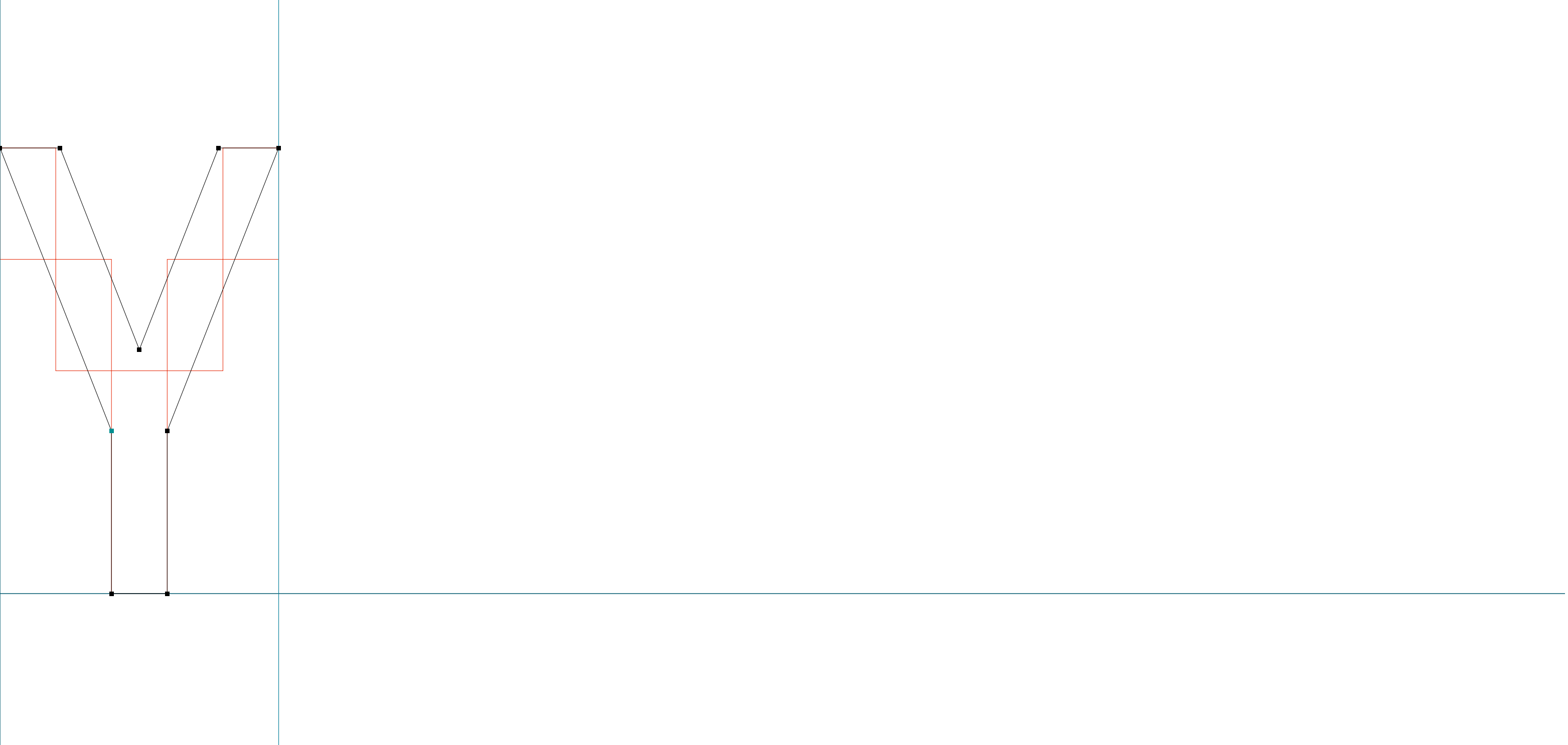

**BASE 9 & 12**

.....  
BaseTwelve SansSmallcaps | b | RoboFog Sketches | 1995 | Emigre Fonts

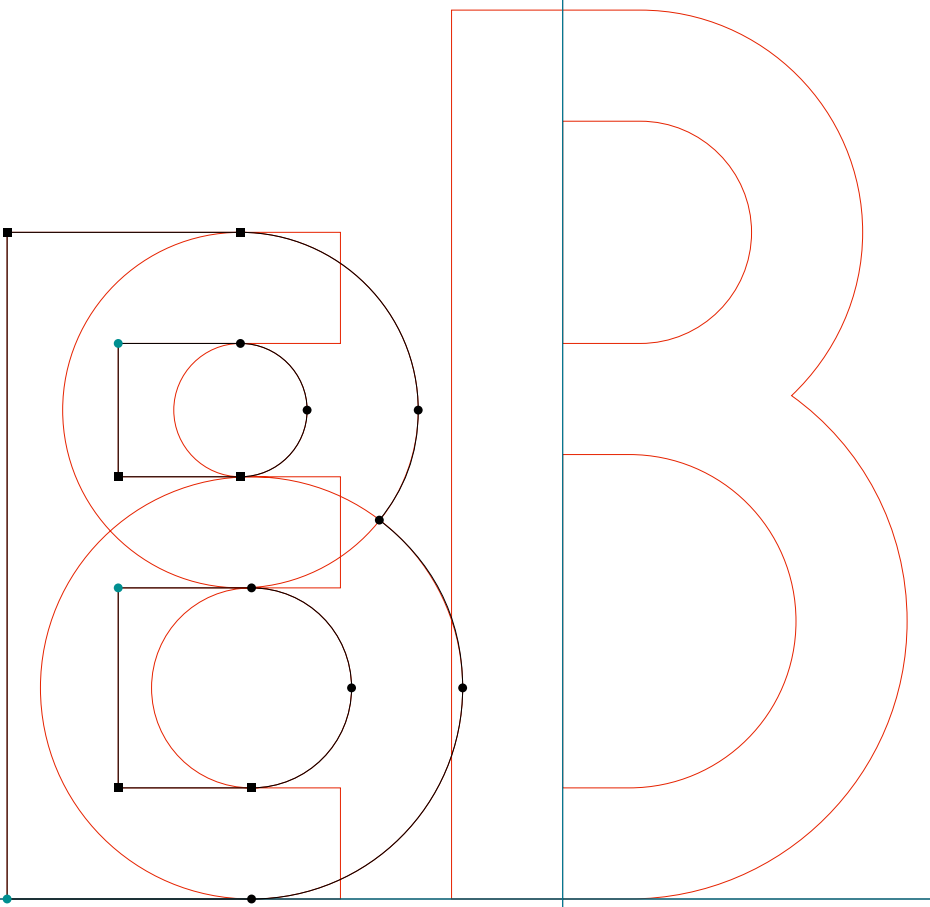

**BASE 9 & 12**

.....  
BaseTwelve SansSmallcaps | d | RoboFog Sketches | 1995 | Emigre Fonts

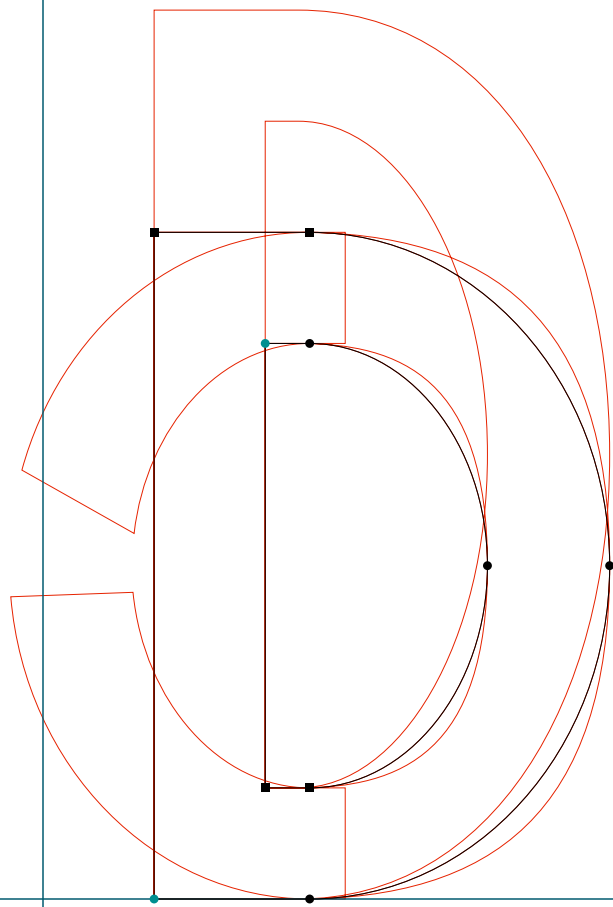
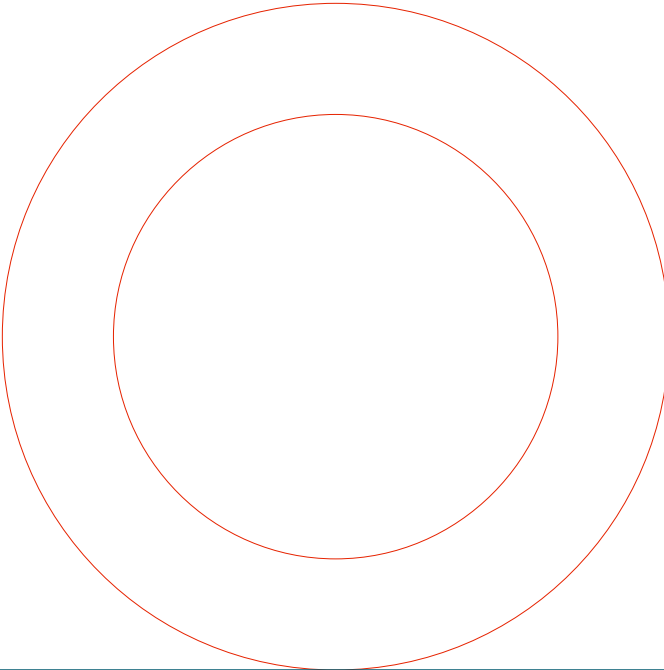

**BASE 9 & 12**

.....  
BaseTwelve SansSmallcaps | g | RoboFog Sketches | 1995 | Emigre Fonts

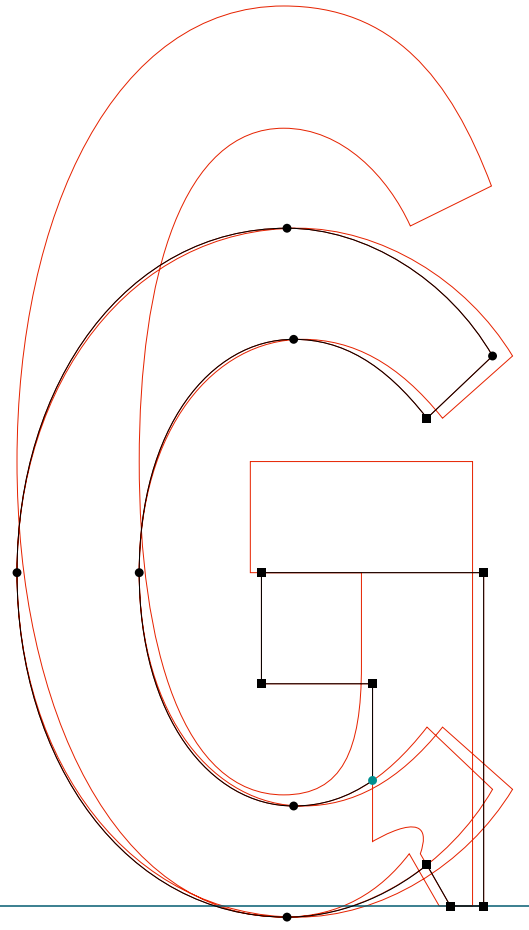

**BASE 9 & 12**

.....  
BaseTwelve SansSmallcaps | m | RoboFog Sketches | 1995 | Emigre Fonts

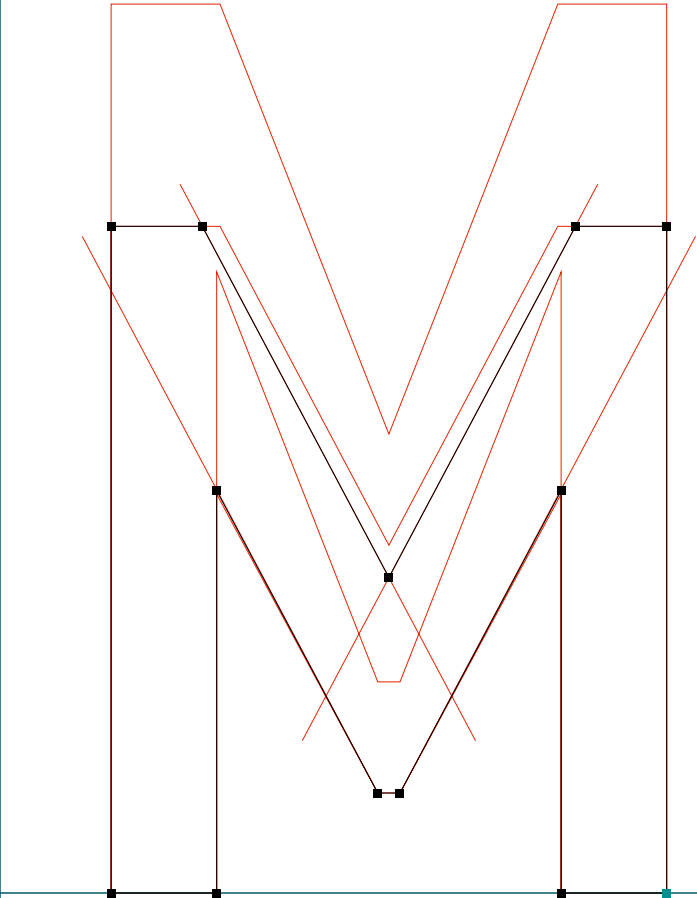

**BASE 9 & 12**

.....  
BaseTwelve SansSmallcaps | braceright | RoboFog Sketches | 1995 | Emigre Fonts

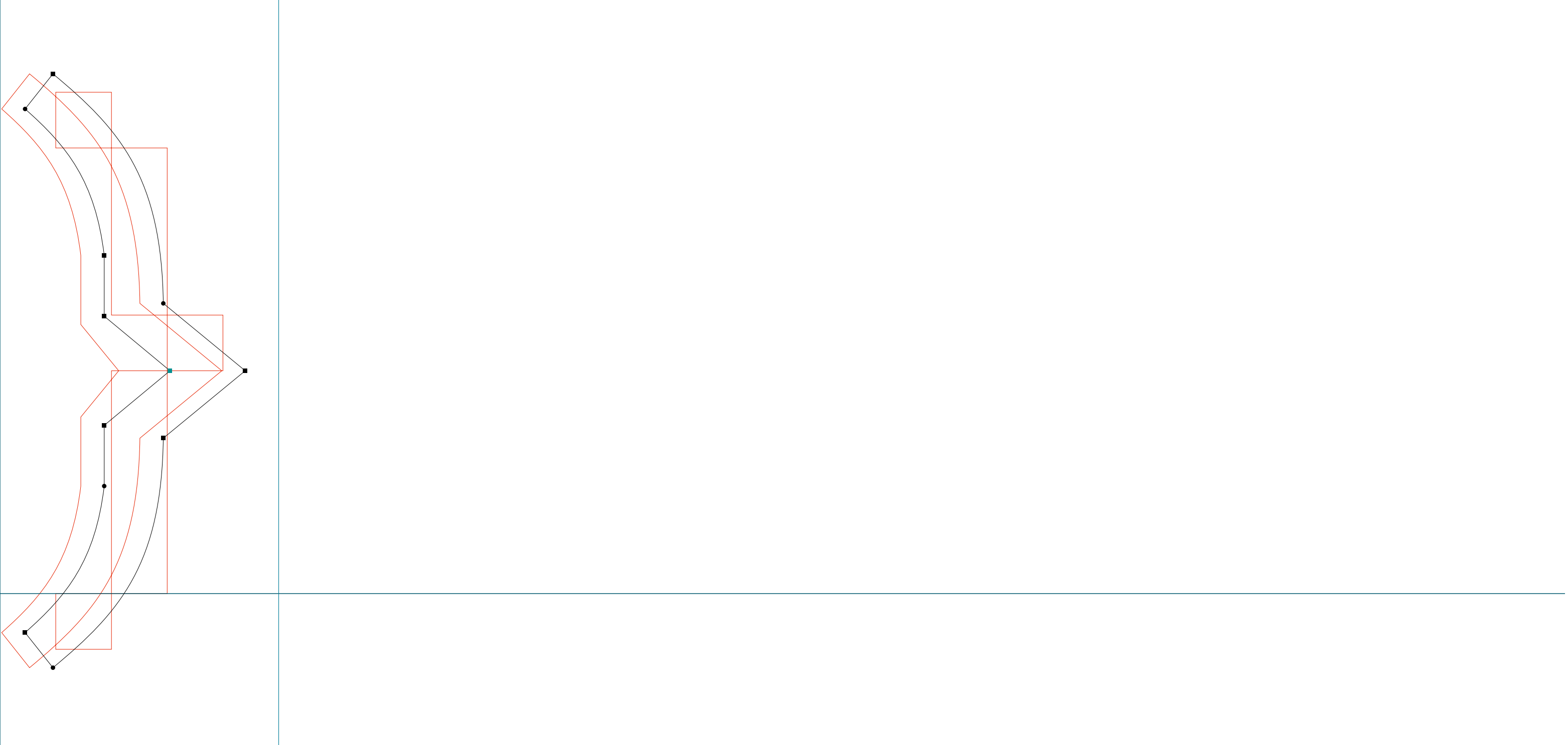

**BASE 9 & 12**

.....  
BaseTwelve SansI | e | RoboFog Sketches | 1995 | Emigre Fonts

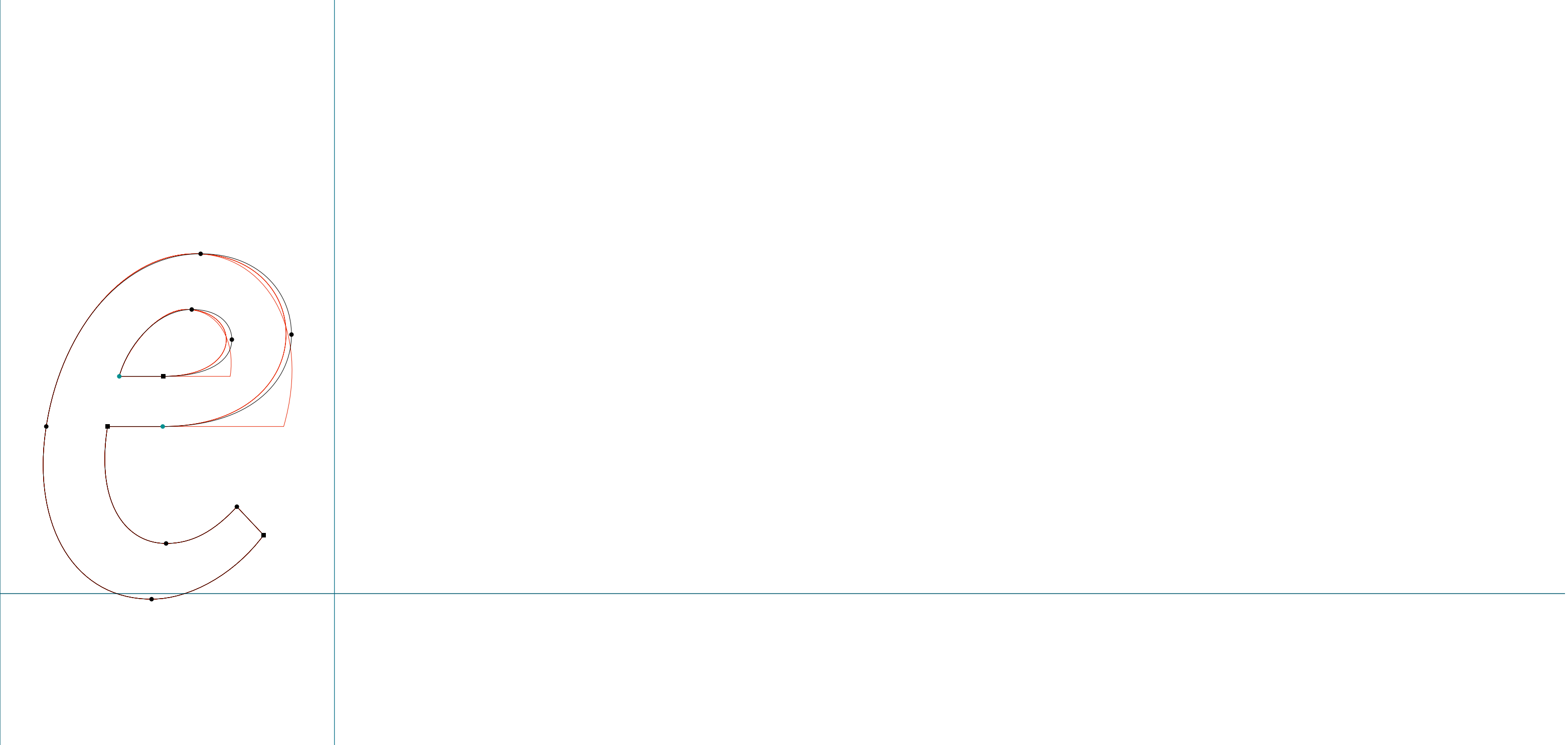



**BASE 9 & 12**

BaseTwelve SansB | quotedbl | RoboFog Sketches | 1995 | Emigre Fonts

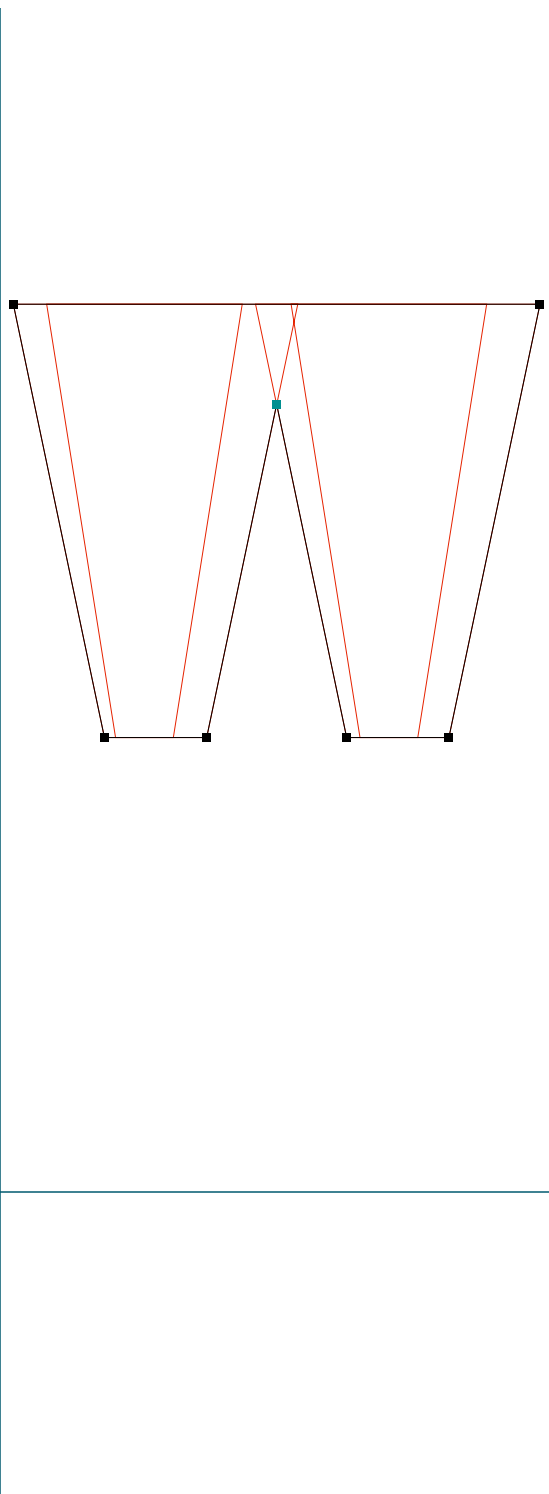

**BASE 9 & 12**

.....  
BaseTwelve SansB | ampersand | RoboFog Sketches | 1995 | Emigre Fonts

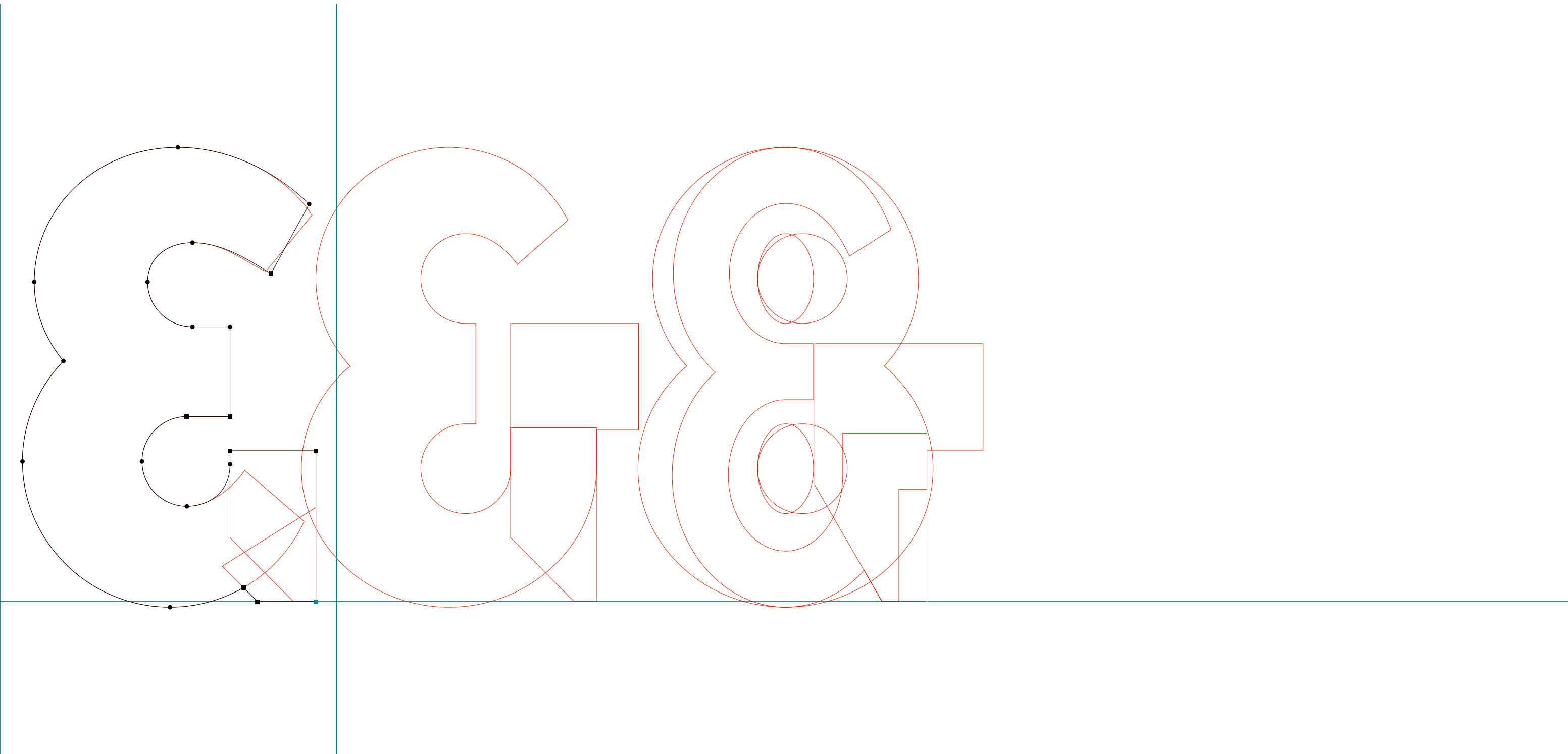

**BASE 9 & 12**

.....  
BaseTwelve SansB | two | RoboFog Sketches | 1995 | Emigre Fonts

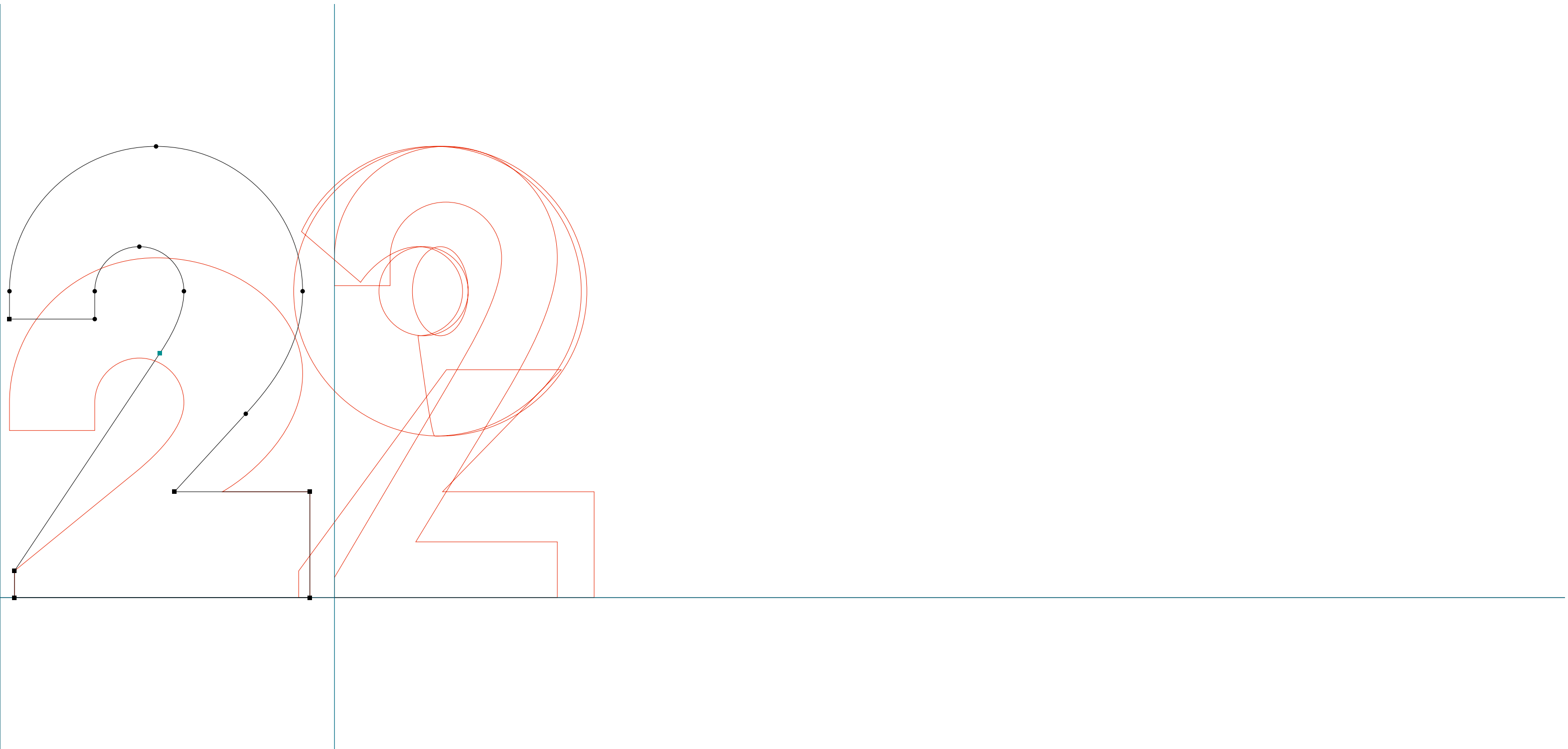

**BASE 9 & 12**

.....  
BaseTwelve SansB | three | RoboFog Sketches | 1995 | Emigre Fonts

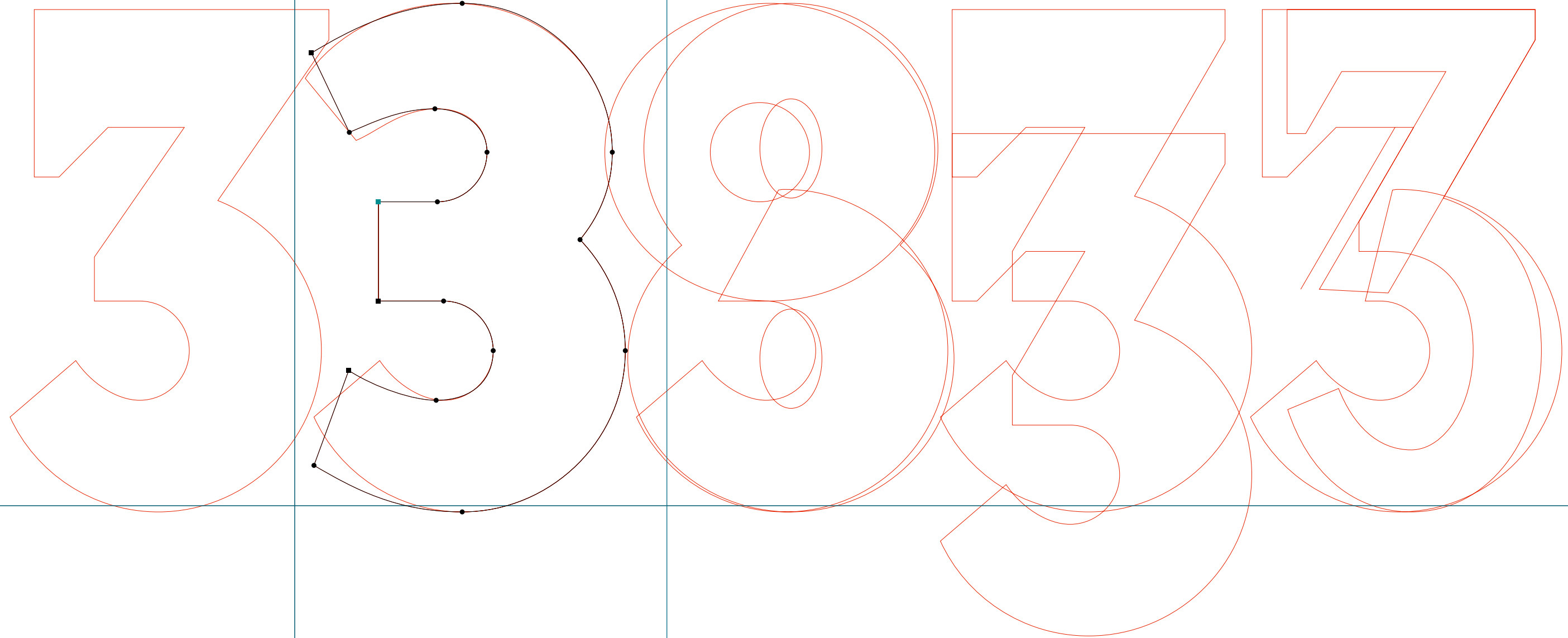

**BASE 9 & 12**

BaseTwelve SansB | five | RoboFog Sketches | 1995 | Emigre Fonts

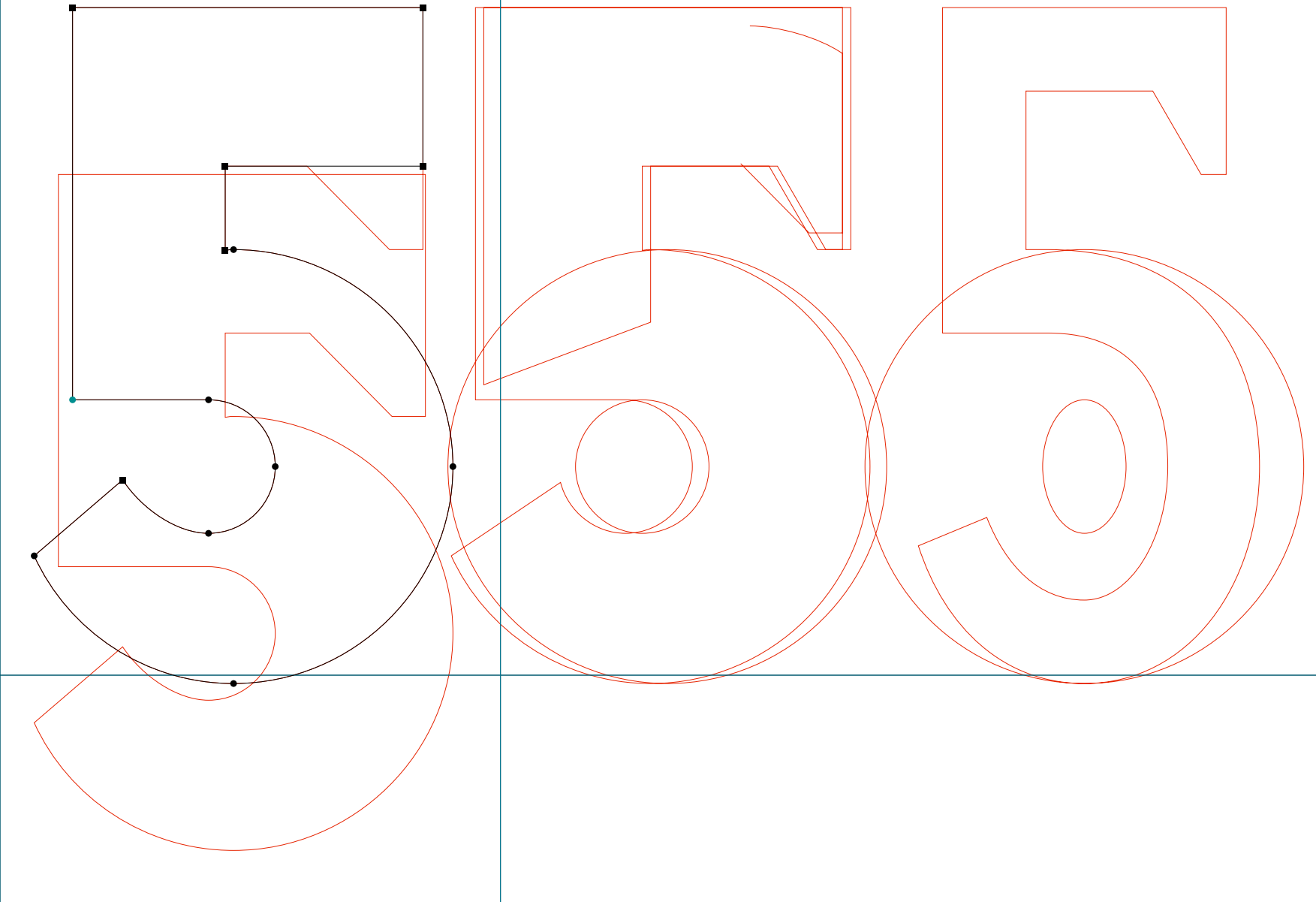

**BASE 9 & 12**

.....  
BaseTwelve SansB | six | RoboFog Sketches | 1995 | Emigre Fonts

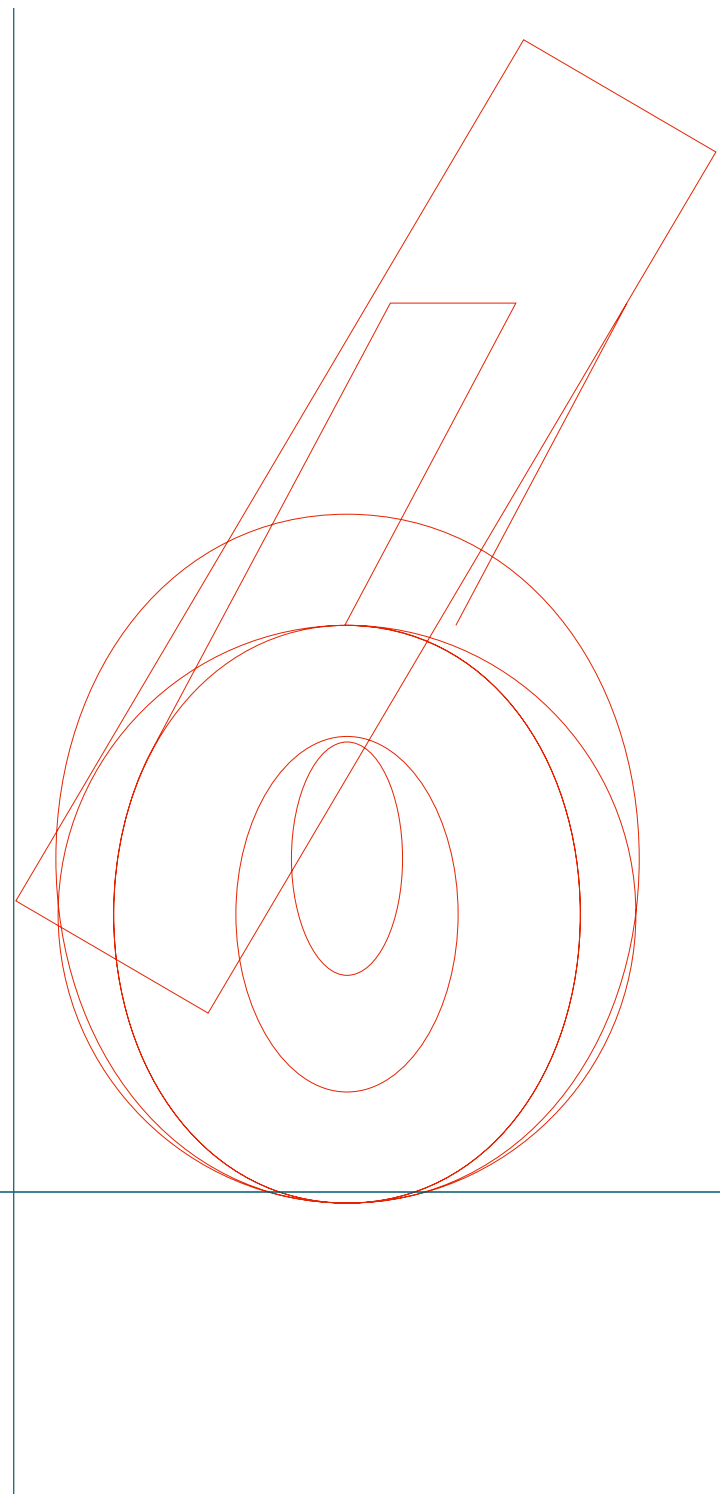
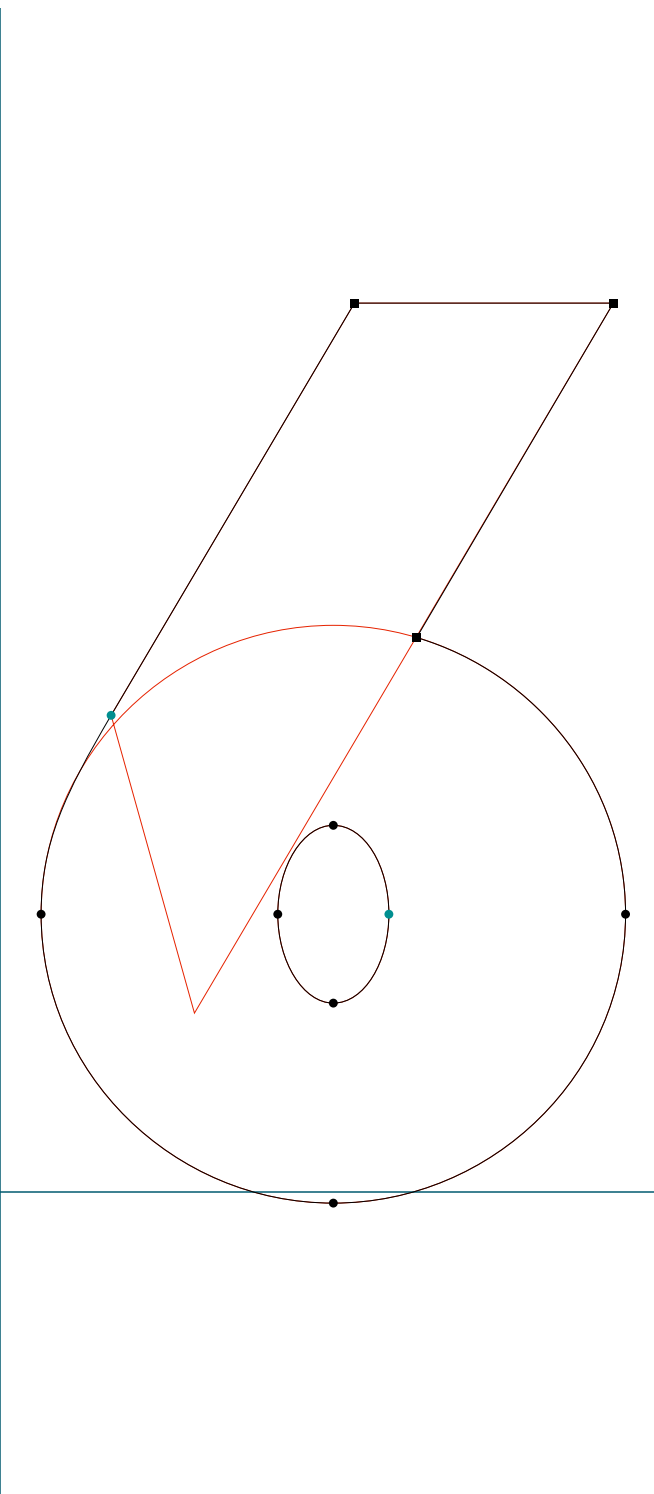

**BASE 9 & 12**

.....  
BaseTwelve SansB | eight | RoboFog Sketches | 1995 | Emigre Fonts

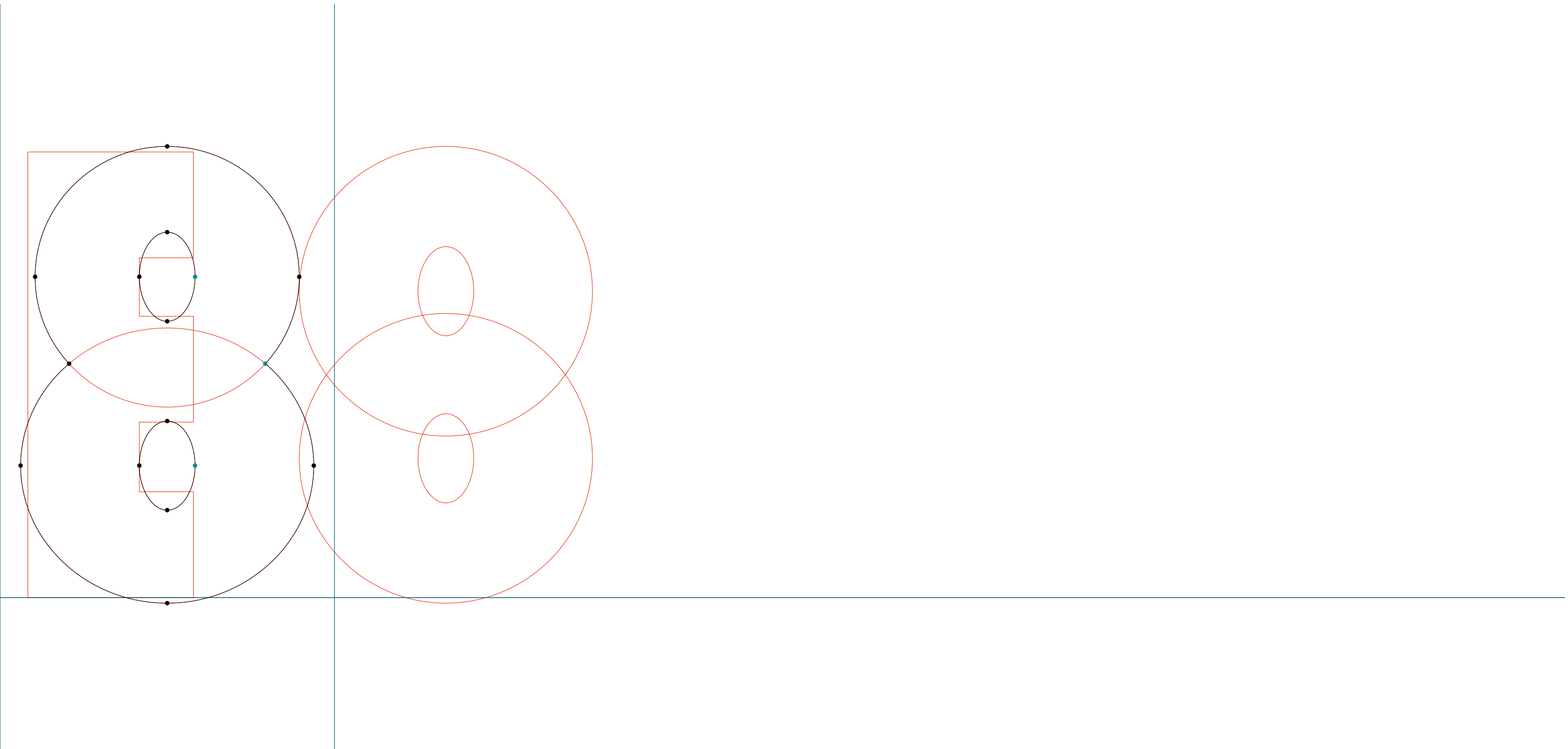

**BASE 9 & 12**

.....  
BaseTwelve SansB | B | RoboFog Sketches | 1995 | Emigre Fonts

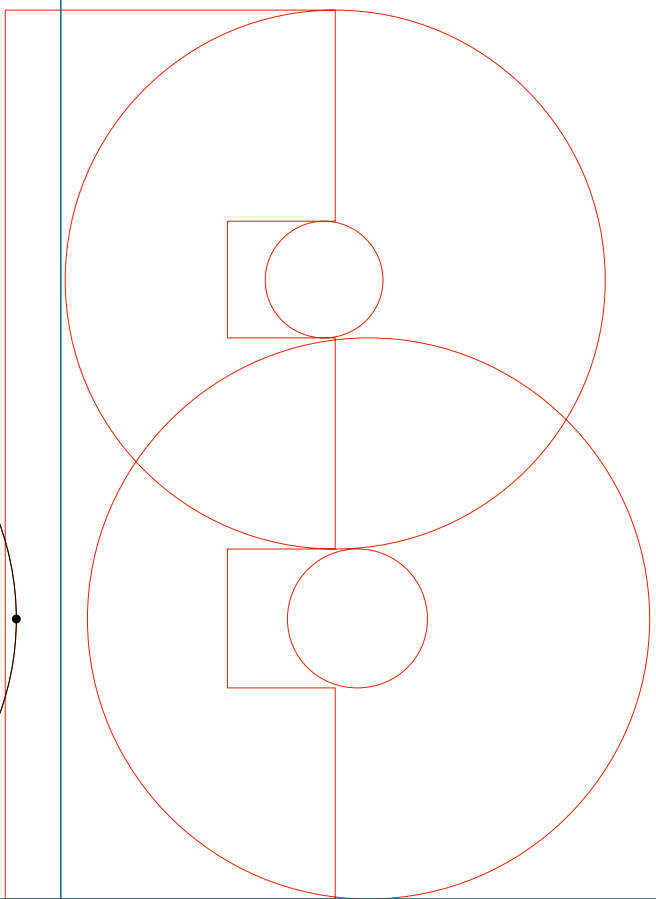
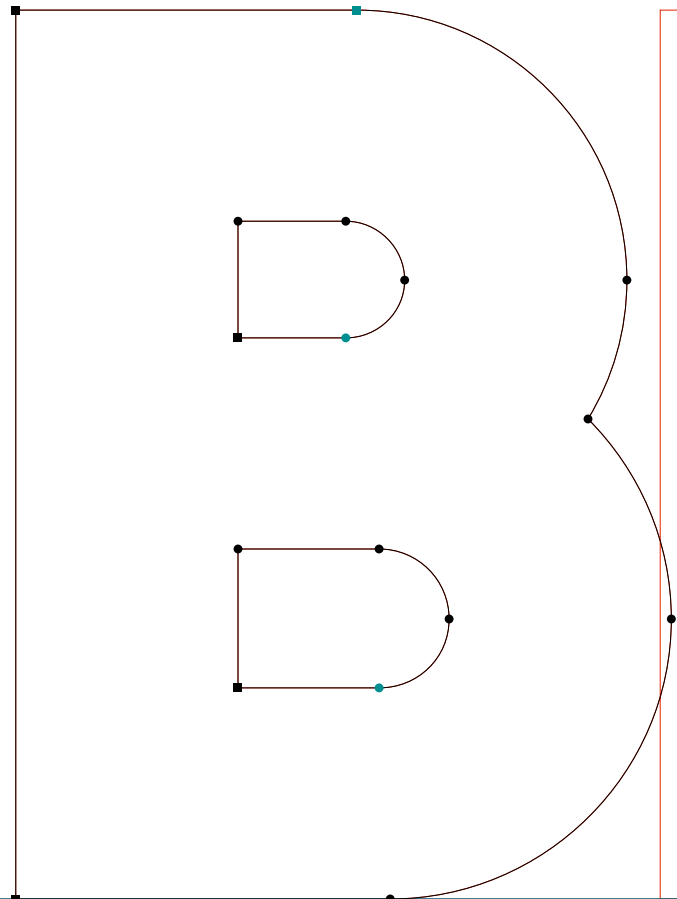
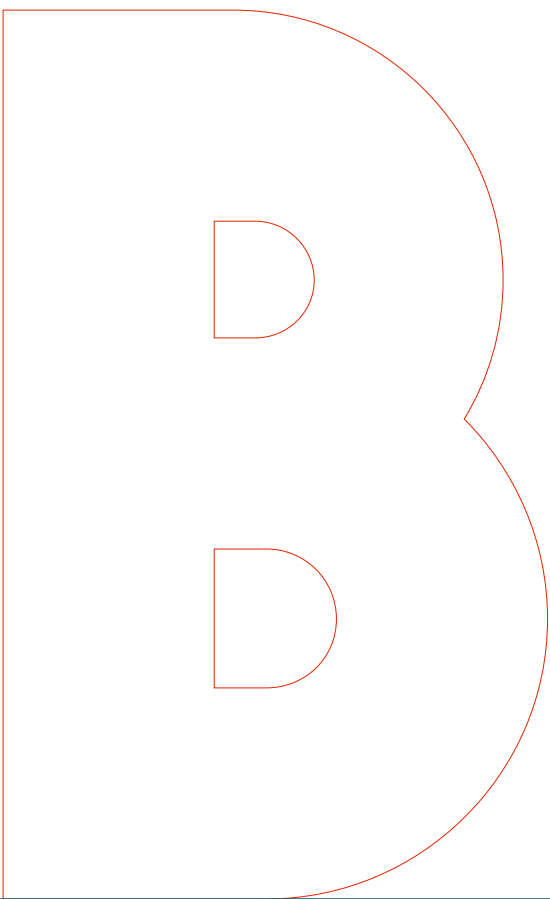



**BASE 9 & 12**

.....  
BaseTwelve SansB | C | RoboFog Sketches | 1995 | Emigre Fonts

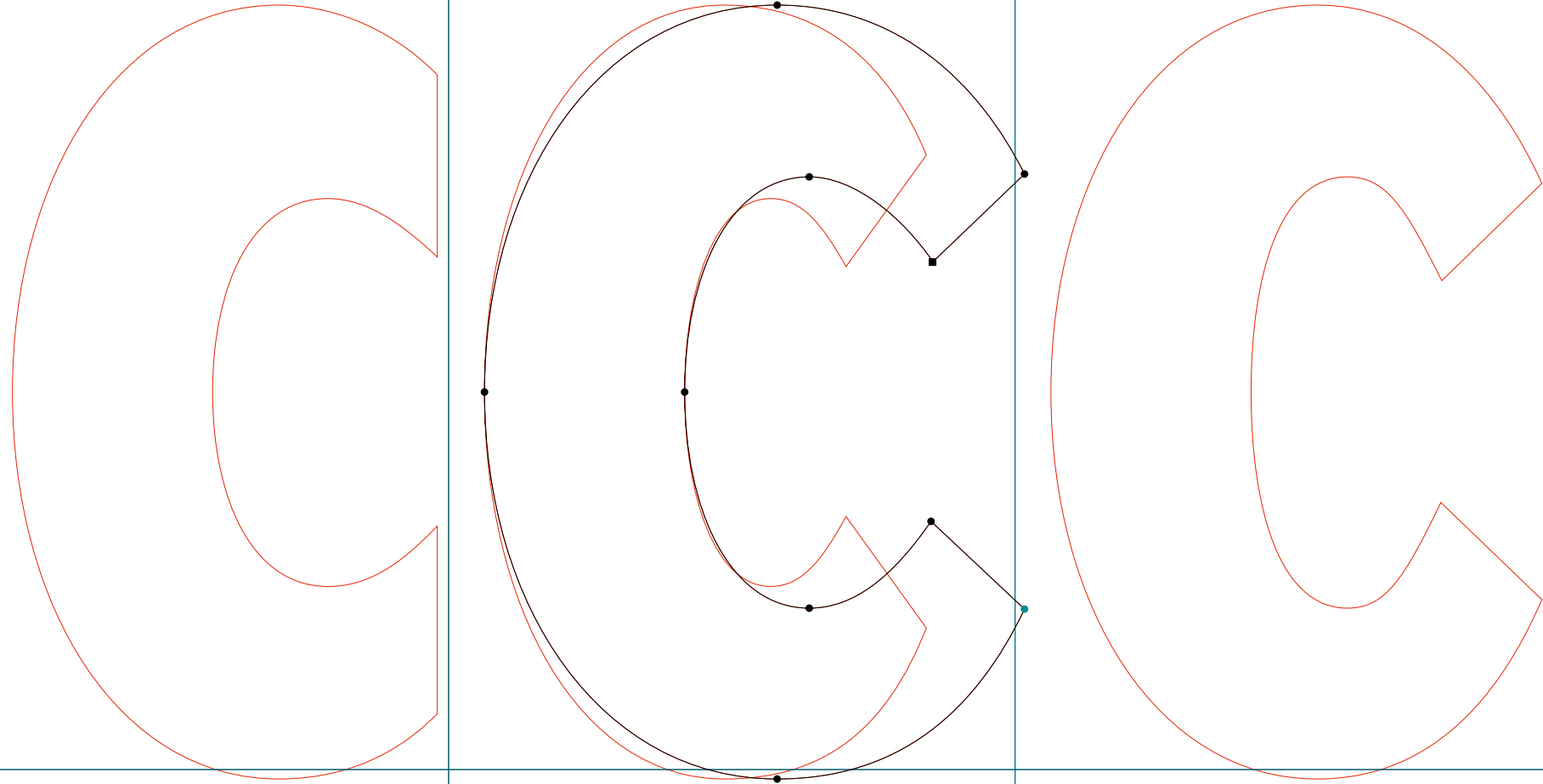

**BASE 9 & 12**

.....  
BaseTwelve SansB | D | RoboFog Sketches | 1995 | Emigre Fonts

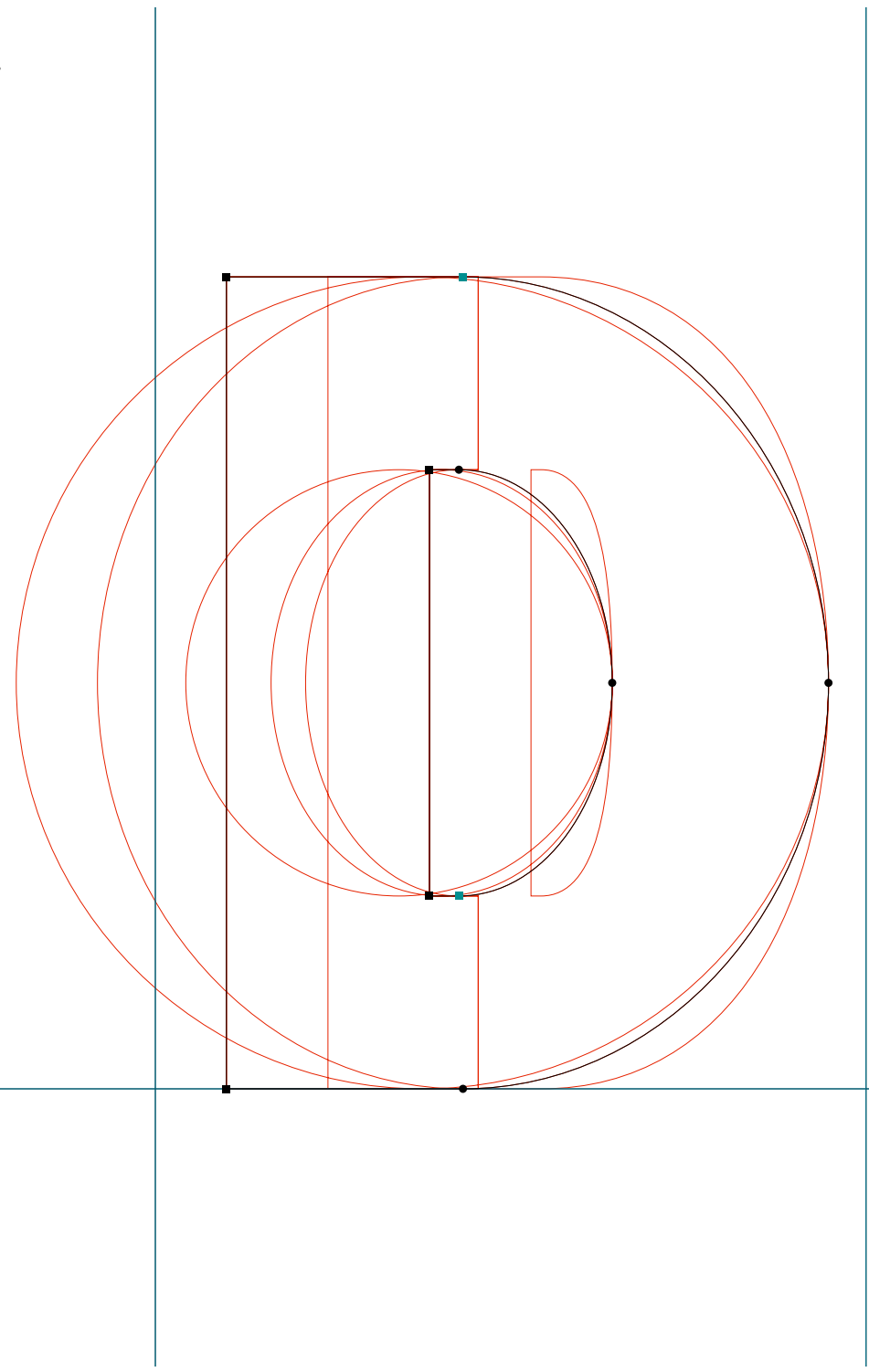

**BASE 9 & 12**

.....  
BaseTwelve SansB | F | RoboFog Sketches | 1995 | Emigre Fonts

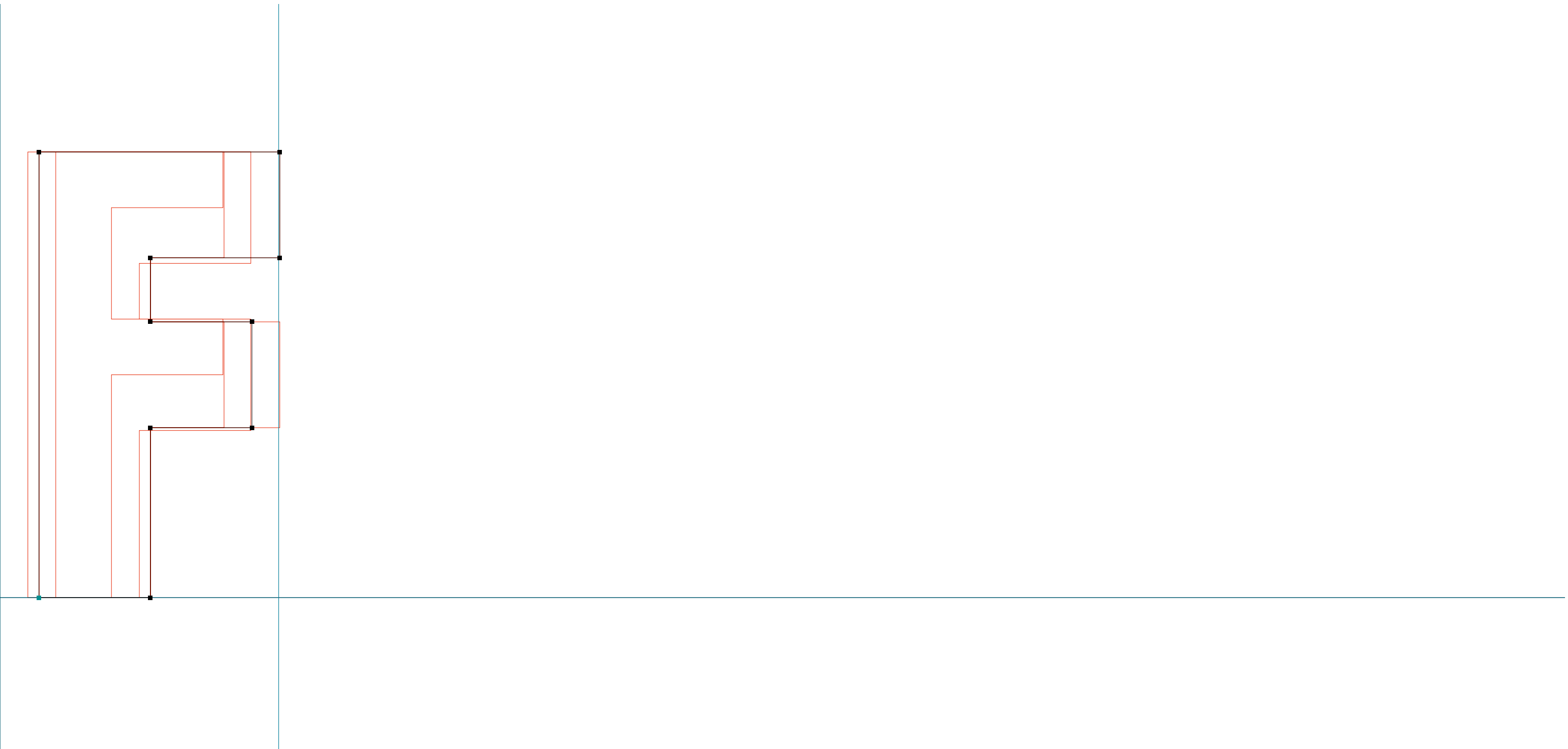

**BASE 9 & 12**

.....  
BaseTwelve SansB | G | RoboFog Sketches | 1995 | Emigre Fonts

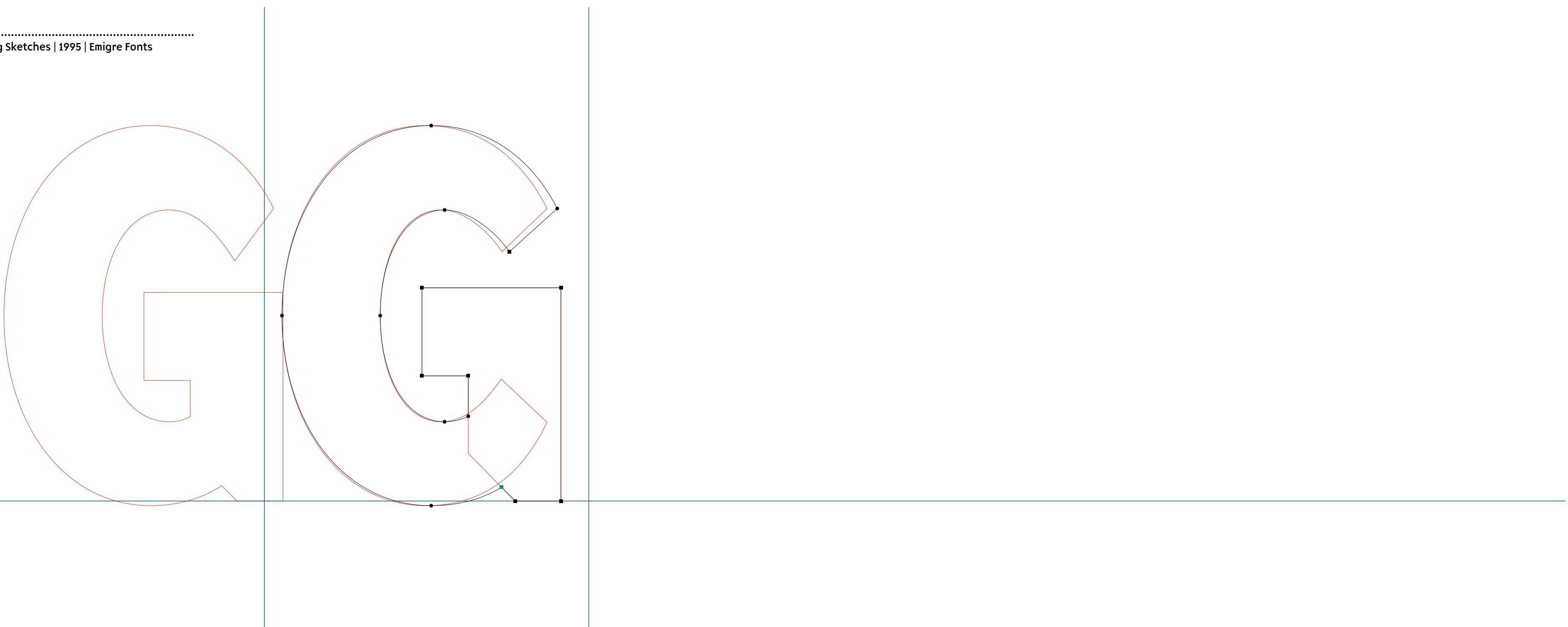

**BASE 9 & 12**

.....  
BaseTwelve SansB | I | RoboFog Sketches | 1995 | Emigre Fonts

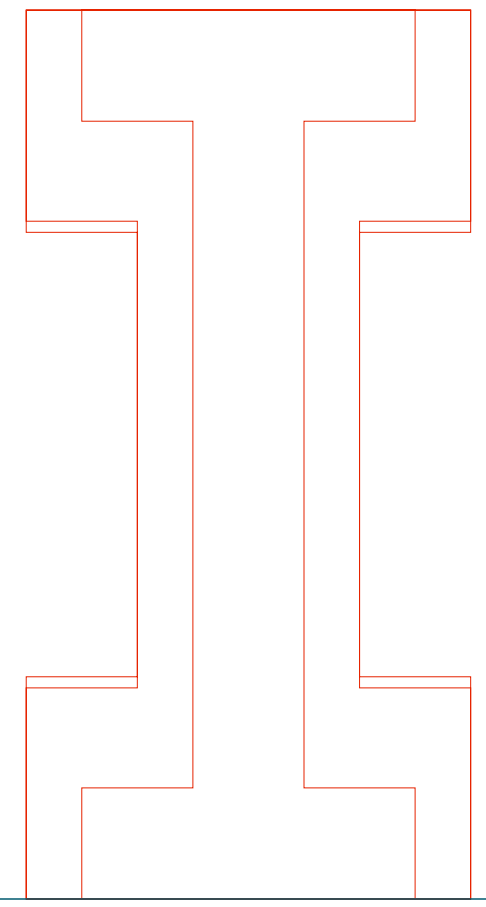
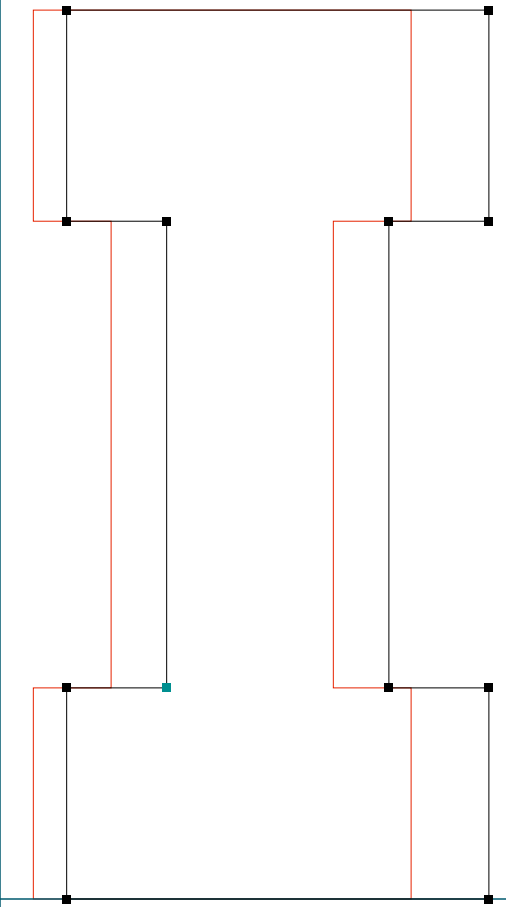

**BASE 9 & 12**

.....  
BaseTwelve SansB | J | RoboFog Sketches | 1995 | Emigre Fonts

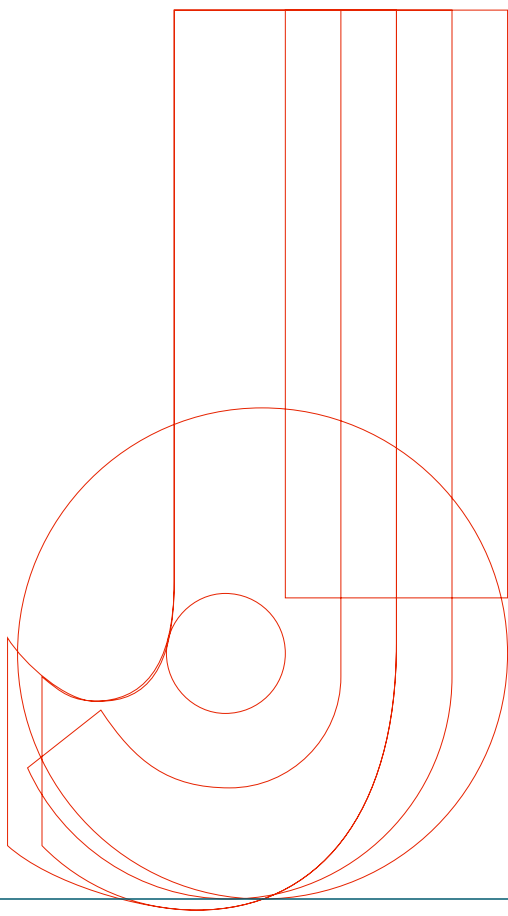
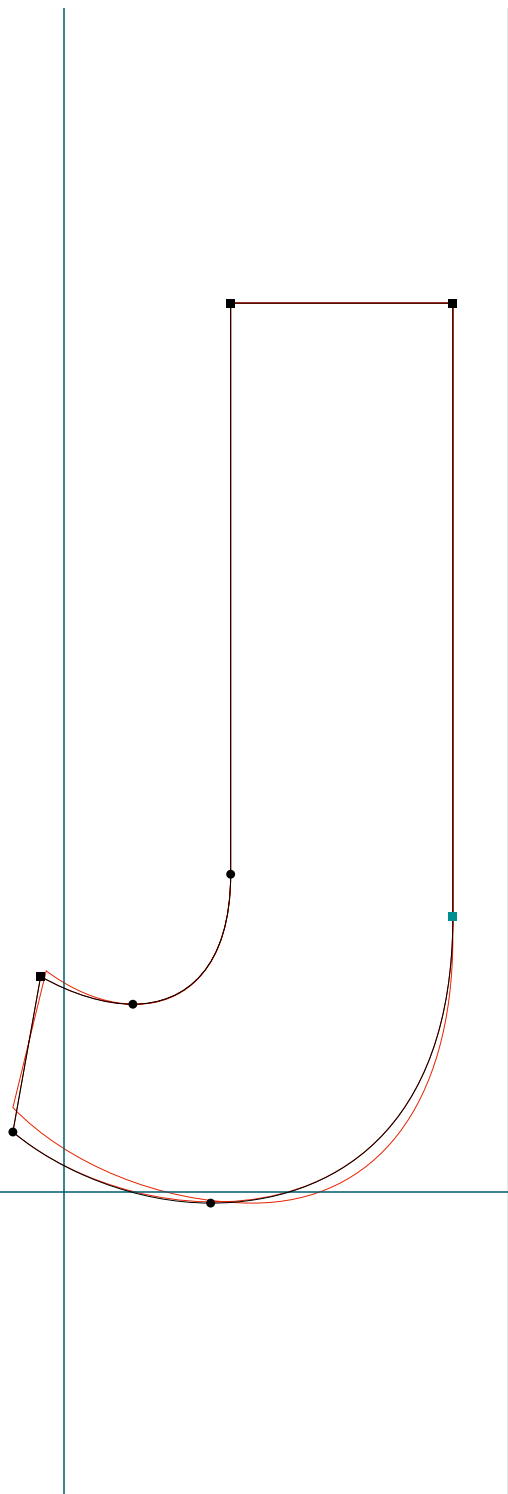

**BASE 9 & 12**

.....  
BaseTwelve SansB | K | RoboFog Sketches | 1995 | Emigre Fonts

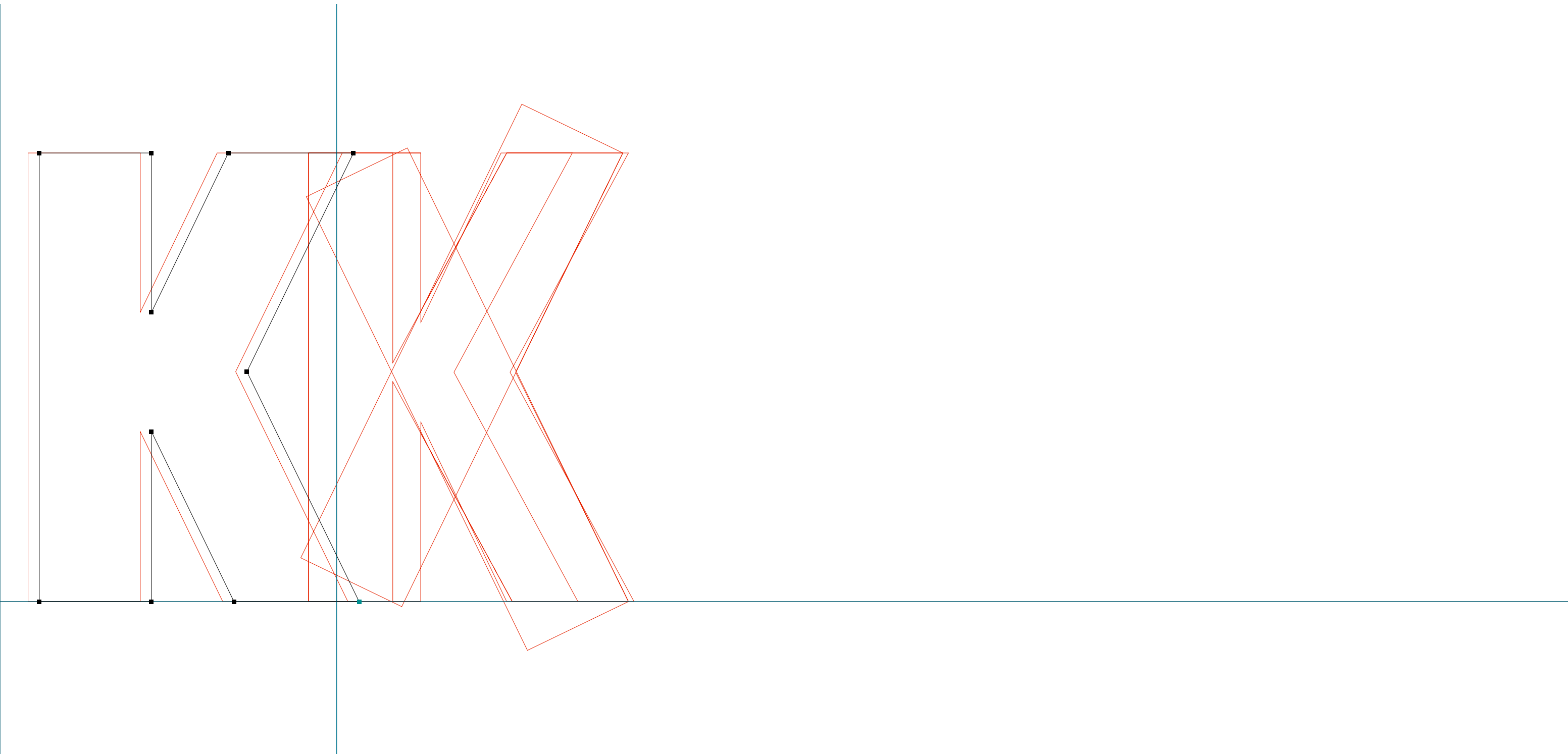

**BASE 9 & 12**

.....  
BaseTwelve SansB | M | RoboFog Sketches | 1995 | Emigre Fonts

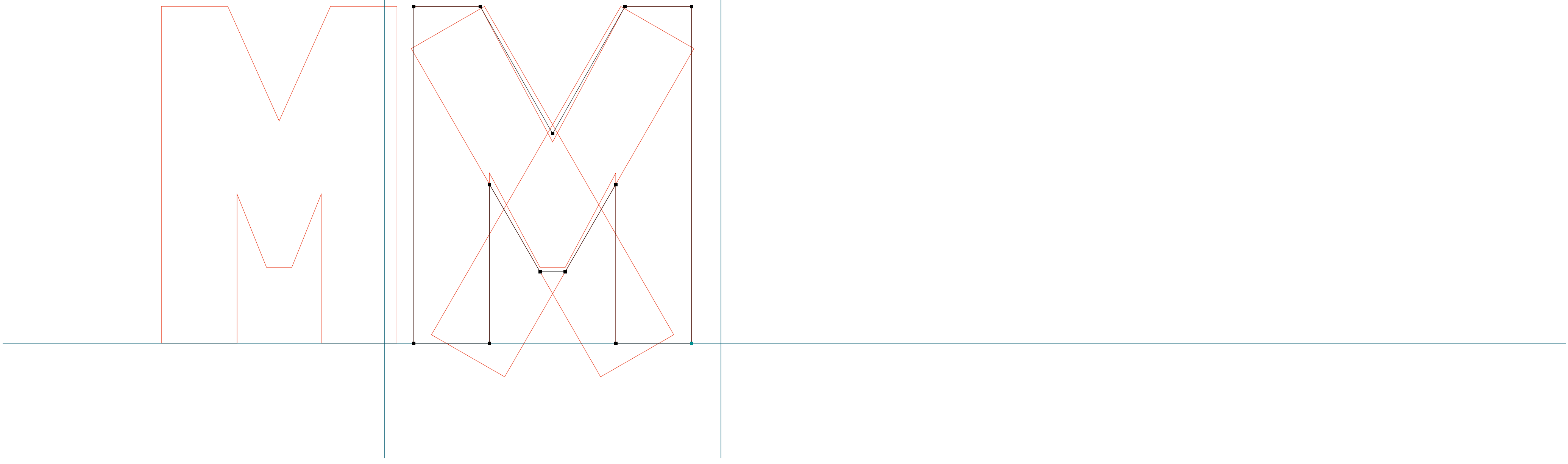



**BASE 9 & 12**

.....  
BaseTwelve SansB | N | RoboFog Sketches | 1995 | Emigre Fonts



**BASE 9 & 12**

.....  
BaseTwelve SansB | P | RoboFog Sketches | 1995 | Emigre Fonts

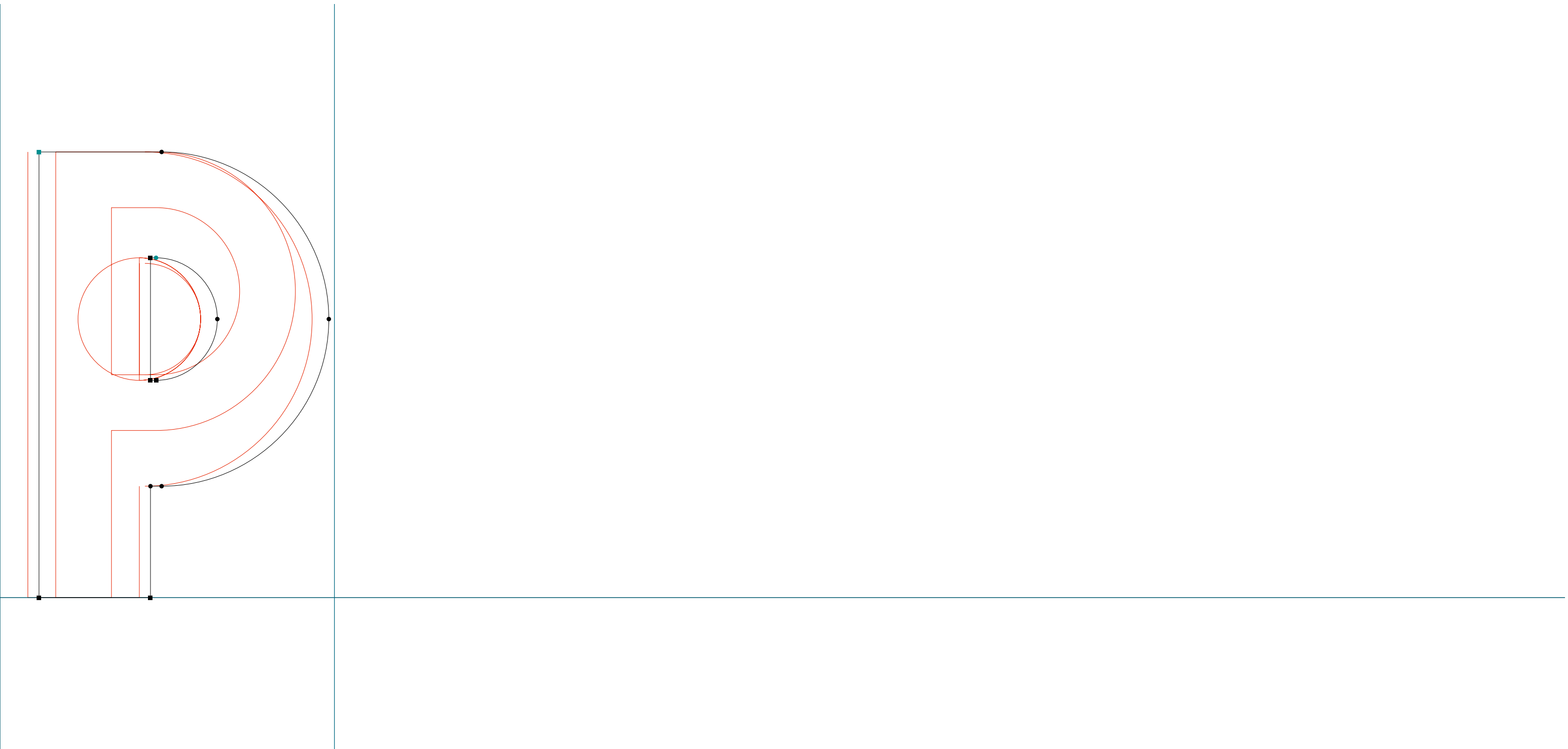

**BASE 9 & 12**

.....  
BaseTwelve SansB | R | RoboFog Sketches | 1995 | Emigre Fonts

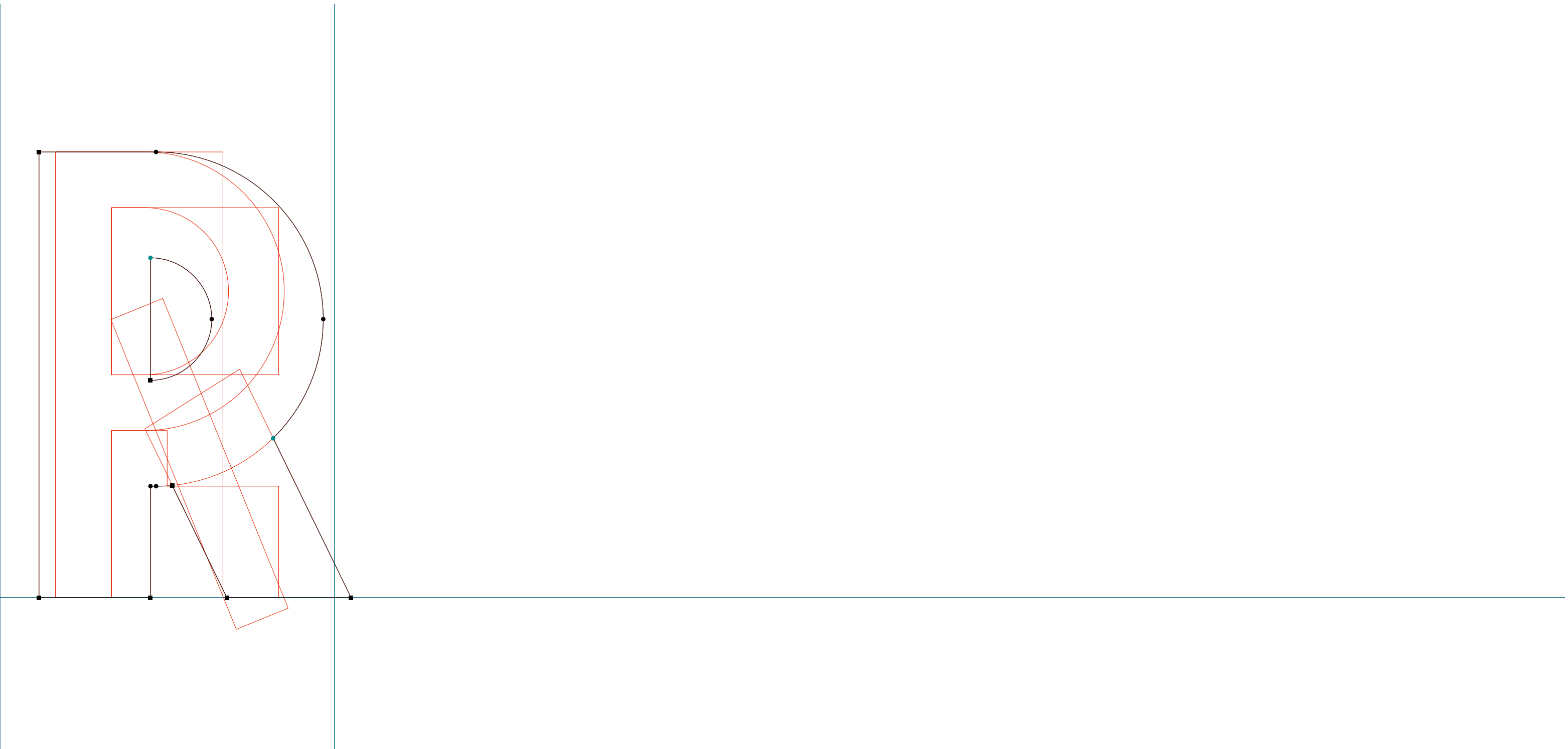

**BASE 9 & 12**

.....  
BaseTwelve SansB | S | RoboFog Sketches | 1995 | Emigre Fonts

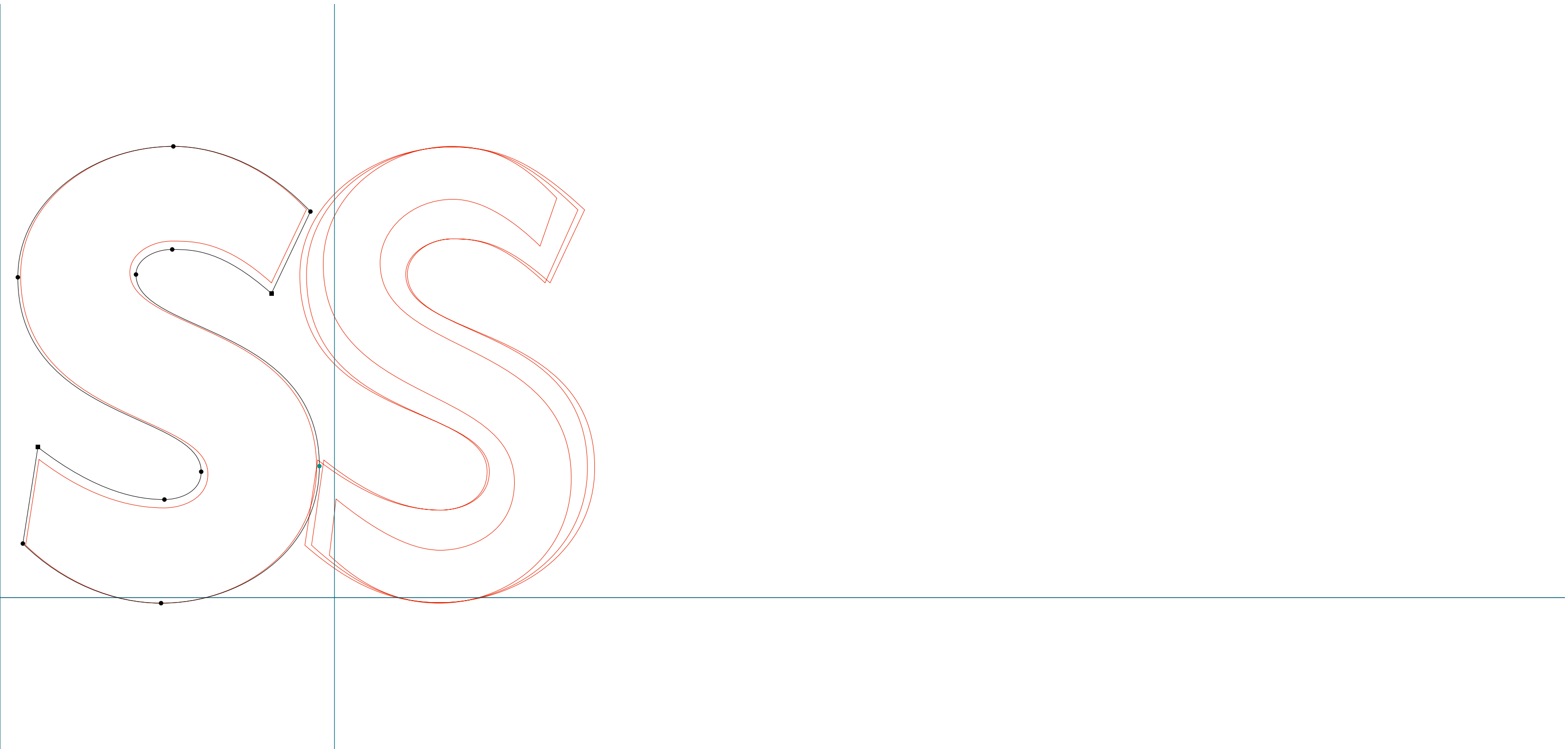

**BASE 9 & 12**

.....  
BaseTwelve SansB | V | RoboFog Sketches | 1995 | Emigre Fonts

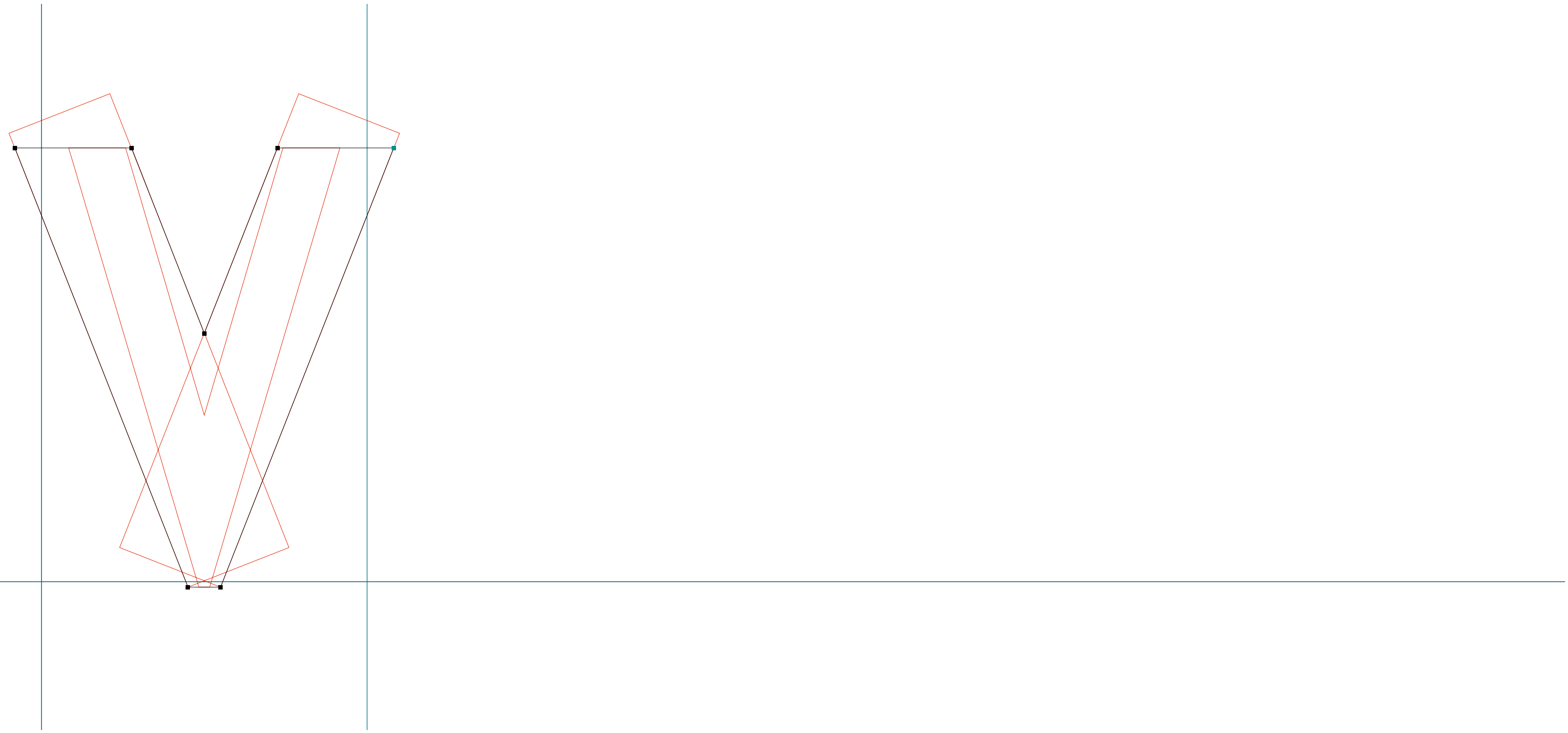

**BASE 9 & 12**

.....  
BaseTwelve SansB | X | RoboFog Sketches | 1995 | Emigre Fonts



**BASE 9 & 12**

.....  
BaseTwelve SansB | Y | RoboFog Sketches | 1995 | Emigre Fonts

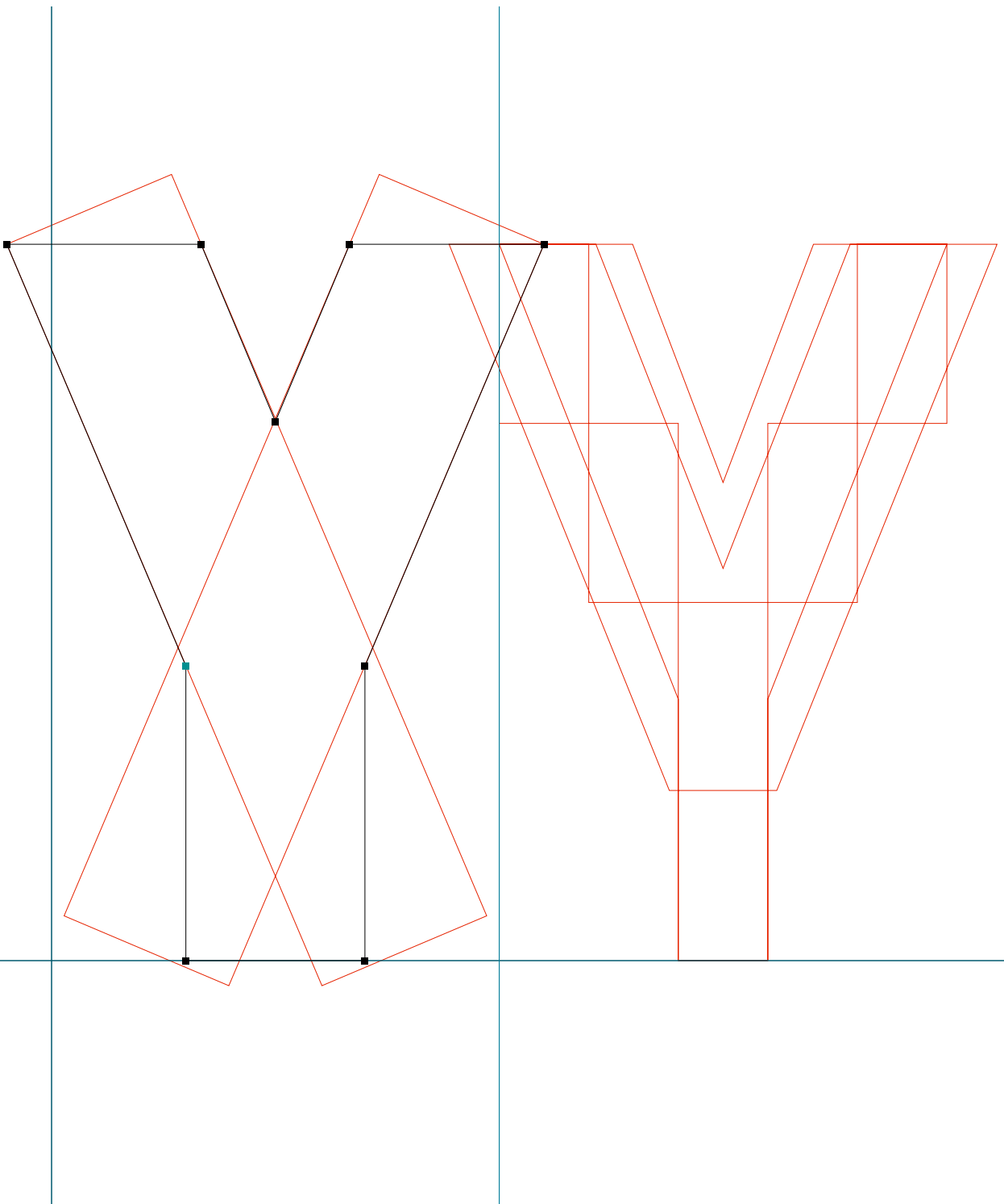

**BASE 9 & 12**

.....  
BaseTwelve SansB | a | RoboFog Sketches | 1995 | Emigre Fonts

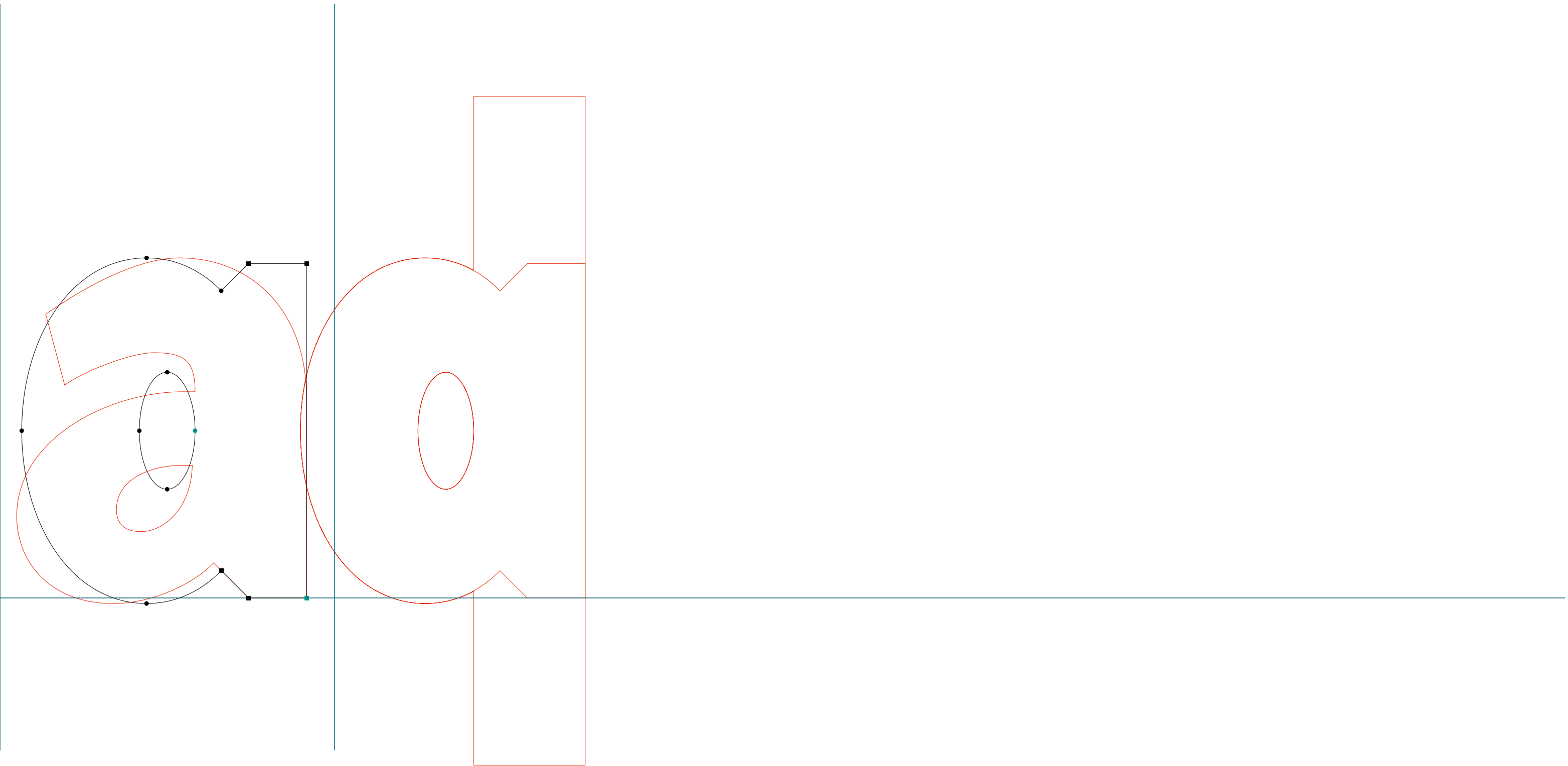



**BASE 9 & 12**

BaseTwelve SansB | c | RoboFog Sketches | 1995 | Emigre Fonts

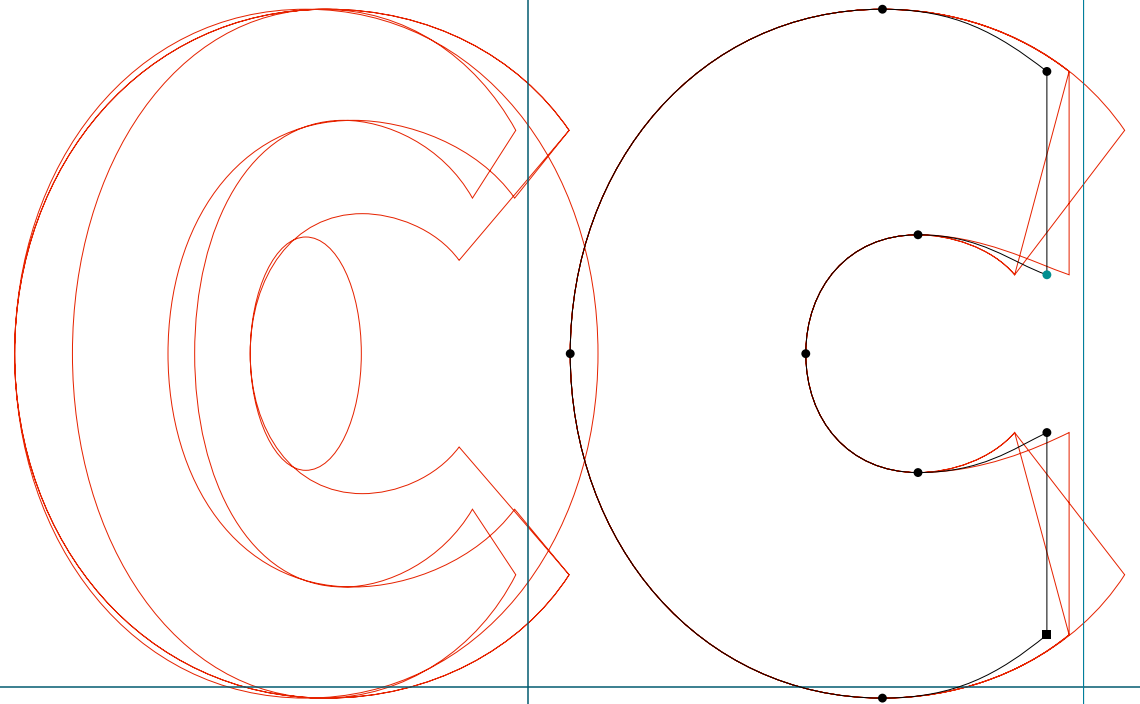

**BASE 9 & 12**

.....  
BaseTwelve SansB | d | RoboFog Sketches | 1995 | Emigre Fonts

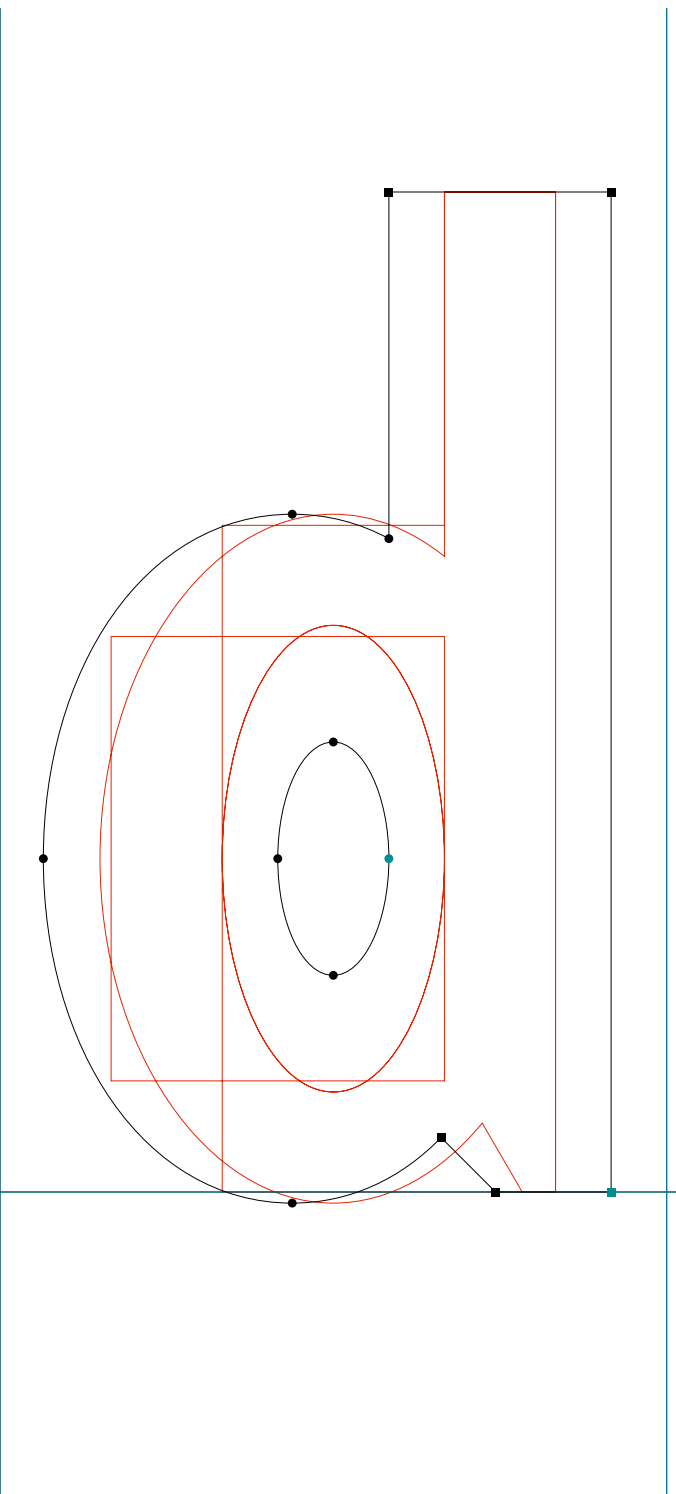

**BASE 9 & 12**

BaseTwelve SansB | e | RoboFog Sketches | 1995 | Emigre Fonts

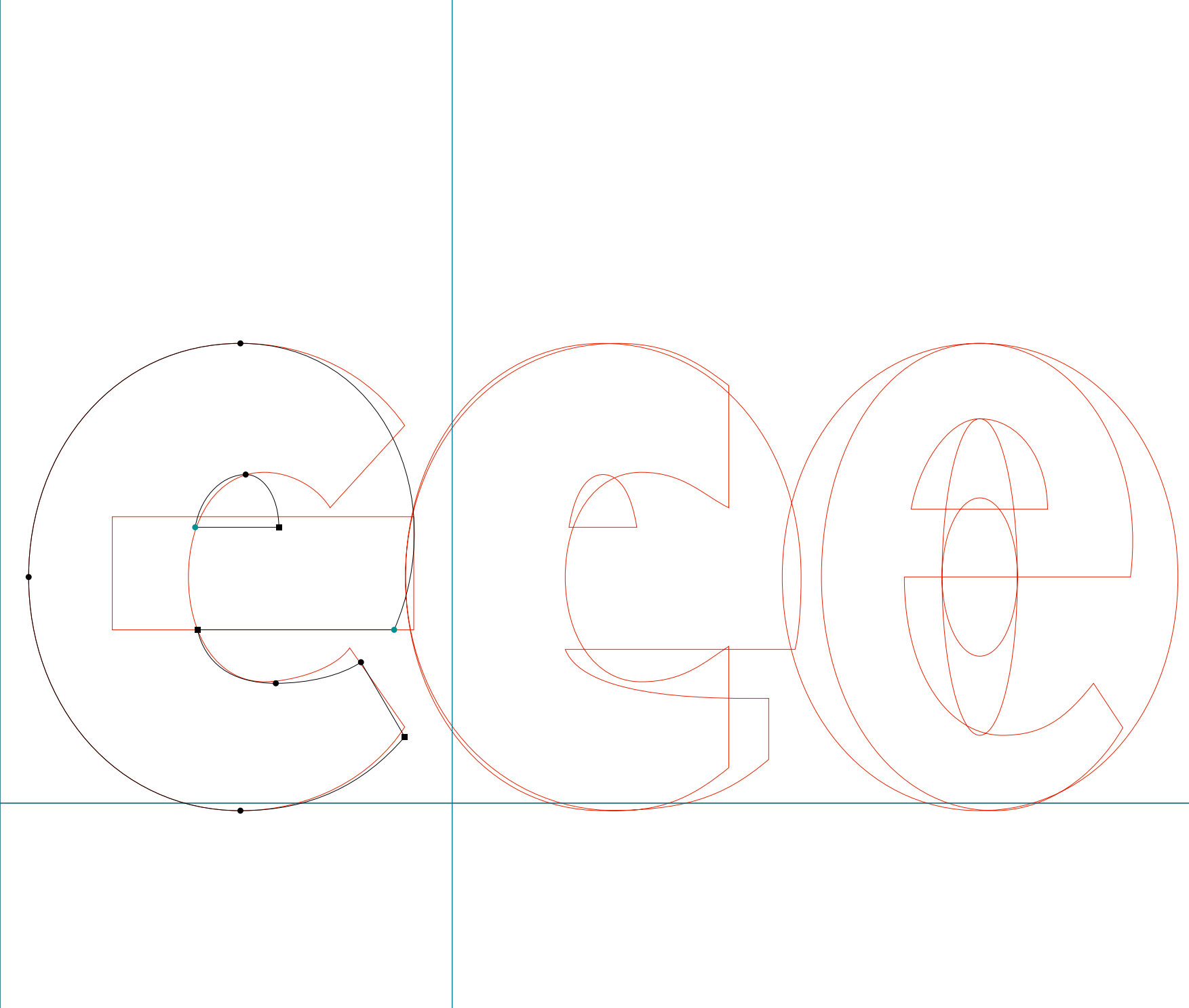

**BASE 9 & 12**

BaseTwelve SansB | f | RoboFog Sketches | 1995 | Emigre Fonts

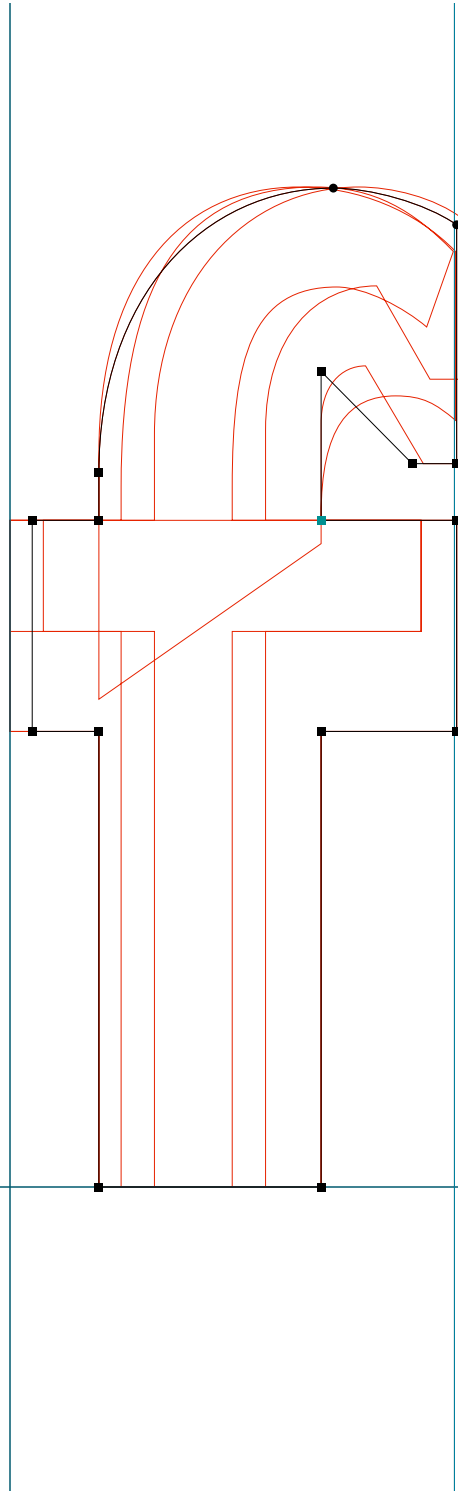

**BASE 9 & 12**

BaseTwelve SansB | g | RoboFog Sketches | 1995 | Emigre Fonts

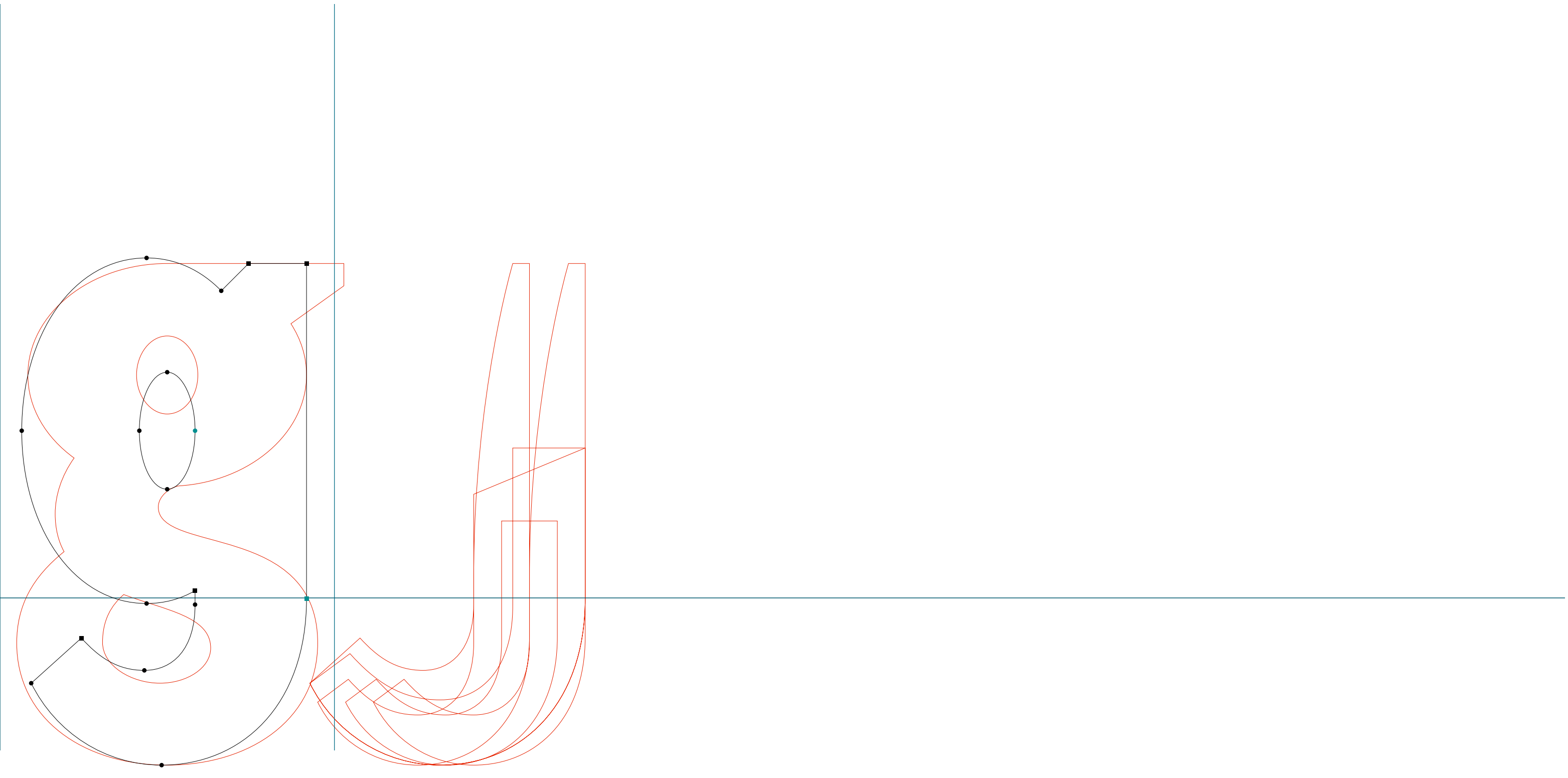

**BASE 9 & 12**

.....  
BaseTwelve SansB | m | RoboFog Sketches | 1995 | Emigre Fonts

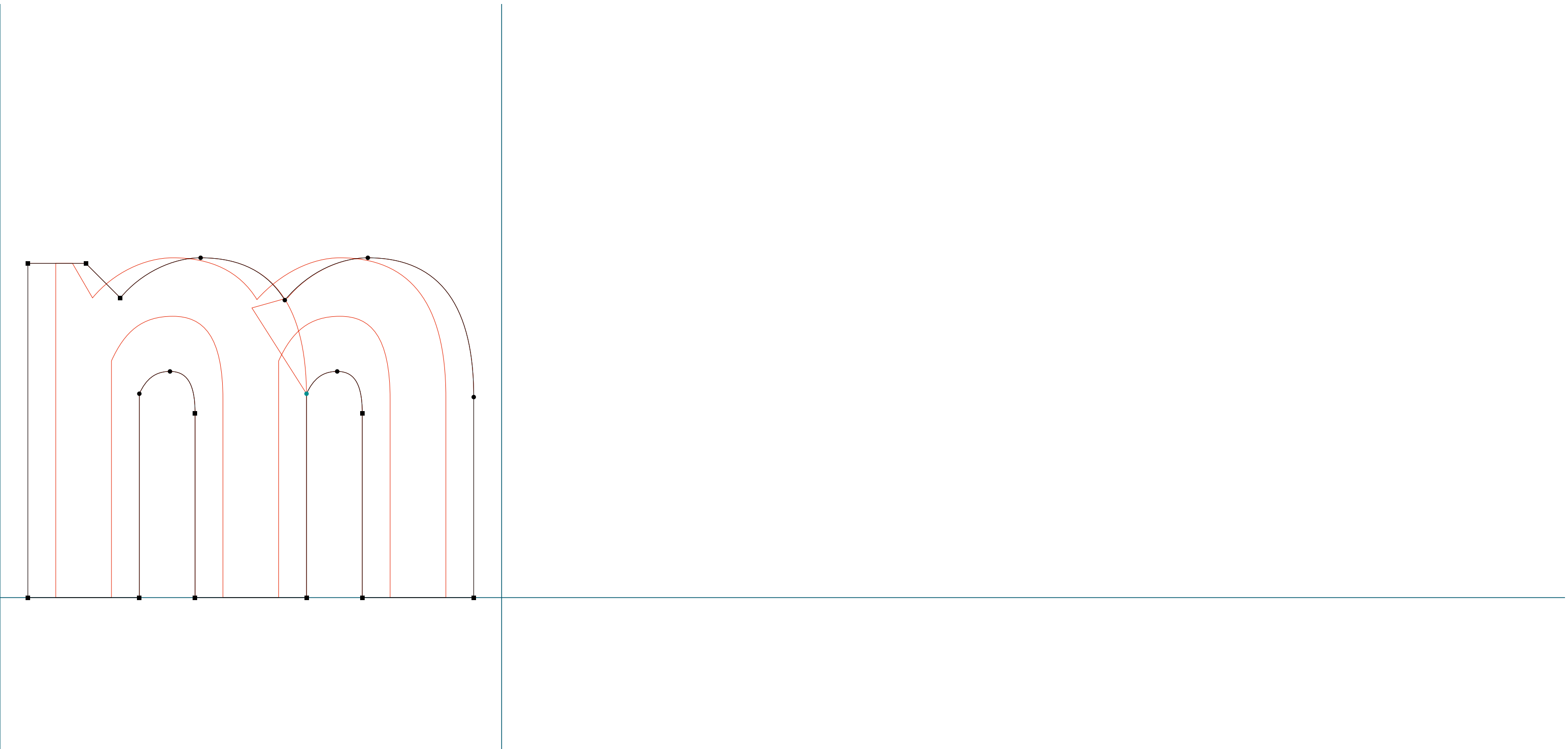

**BASE 9 & 12**

.....  
BaseTwelve SansB | p | RoboFog Sketches | 1995 | Emigre Fonts

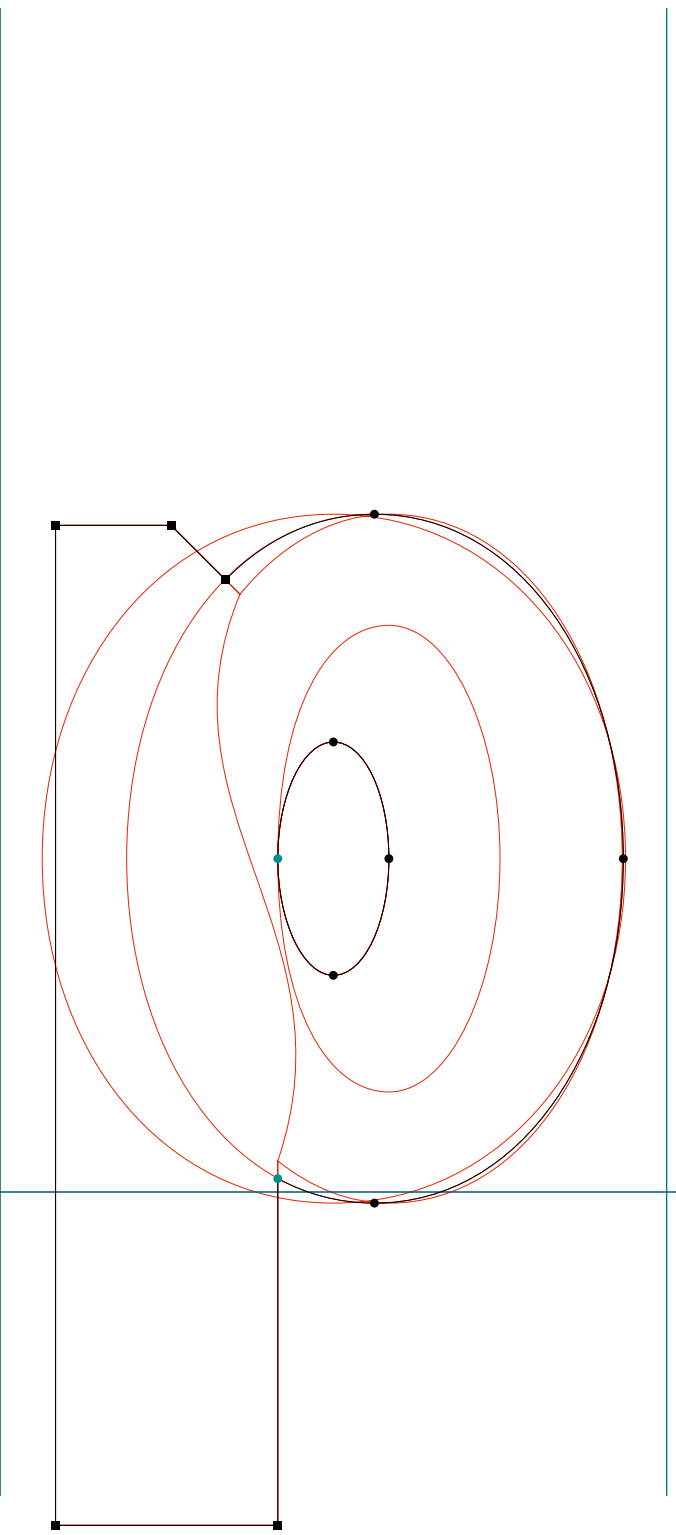

**BASE 9 & 12**

.....  
BaseTwelve SansB | r | RoboFog Sketches | 1995 | Emigre Fonts

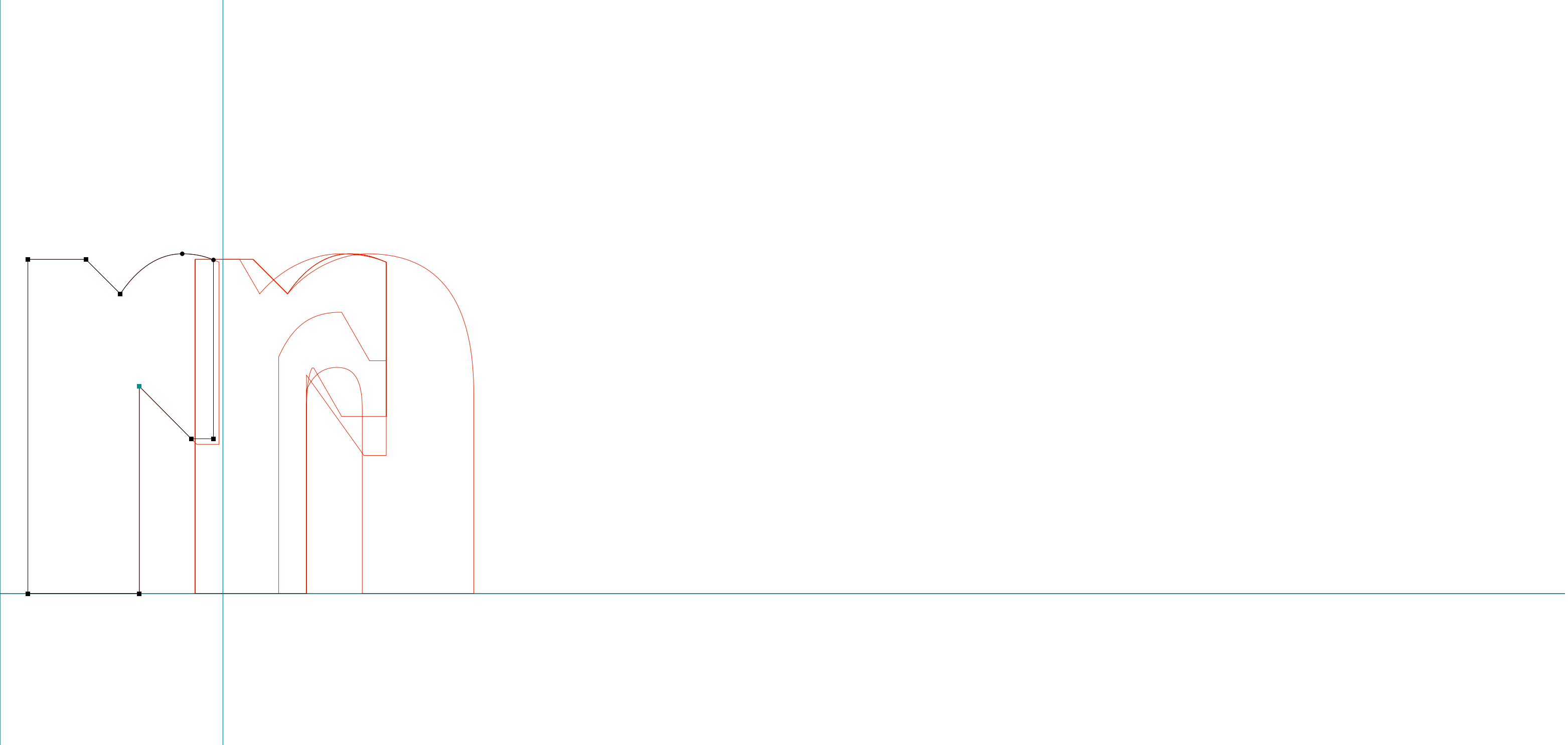



**BASE 9 & 12**

.....  
BaseTwelve SansB | s | RoboFog Sketches | 1995 | Emigre Fonts

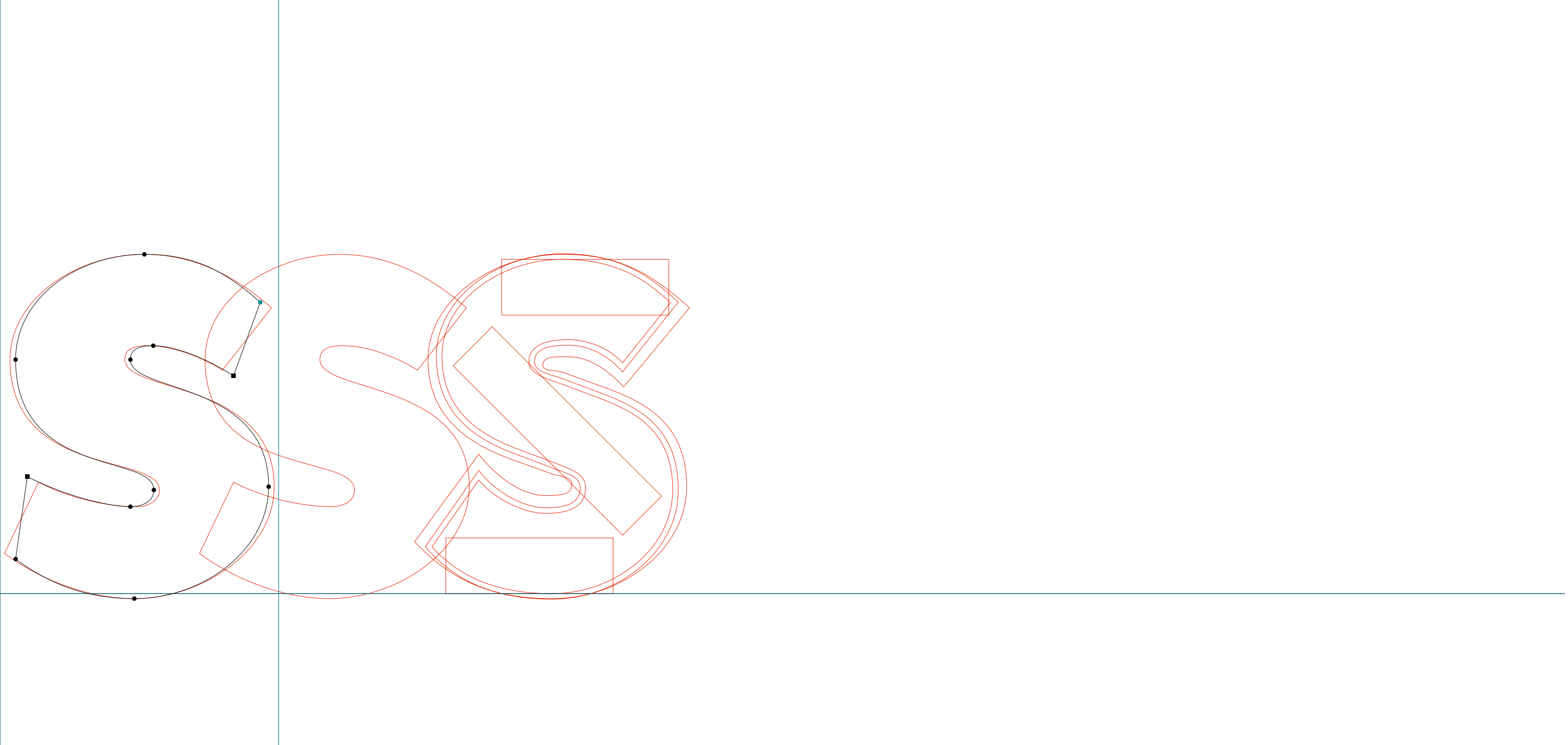

**BASE 9 & 12**

BaseTwelve SansB | t | RoboFog Sketches | 1995 | Emigre Fonts

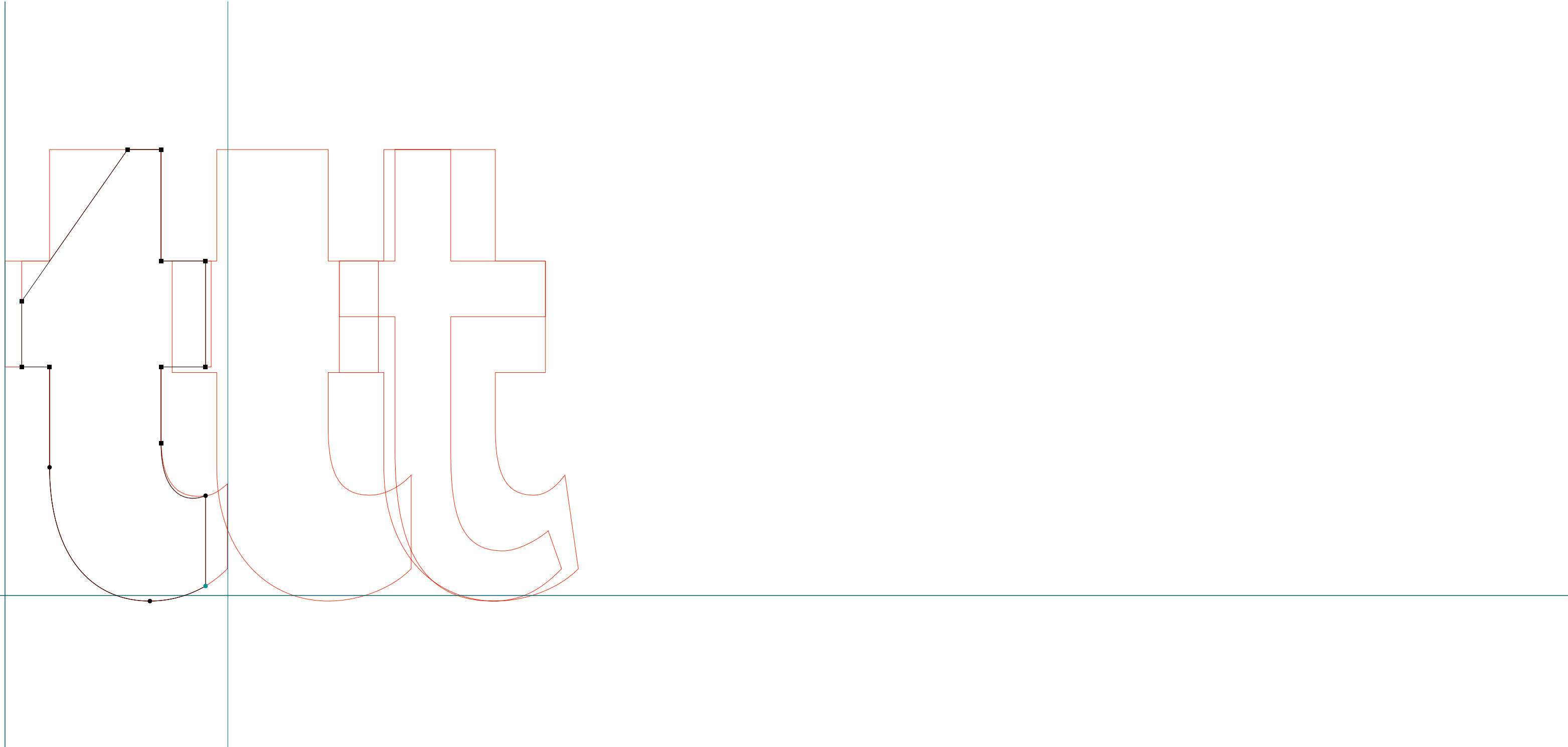

**BASE 9 & 12**

.....  
BaseTwelve SansB | v | RoboFog Sketches | 1995 | Emigre Fonts

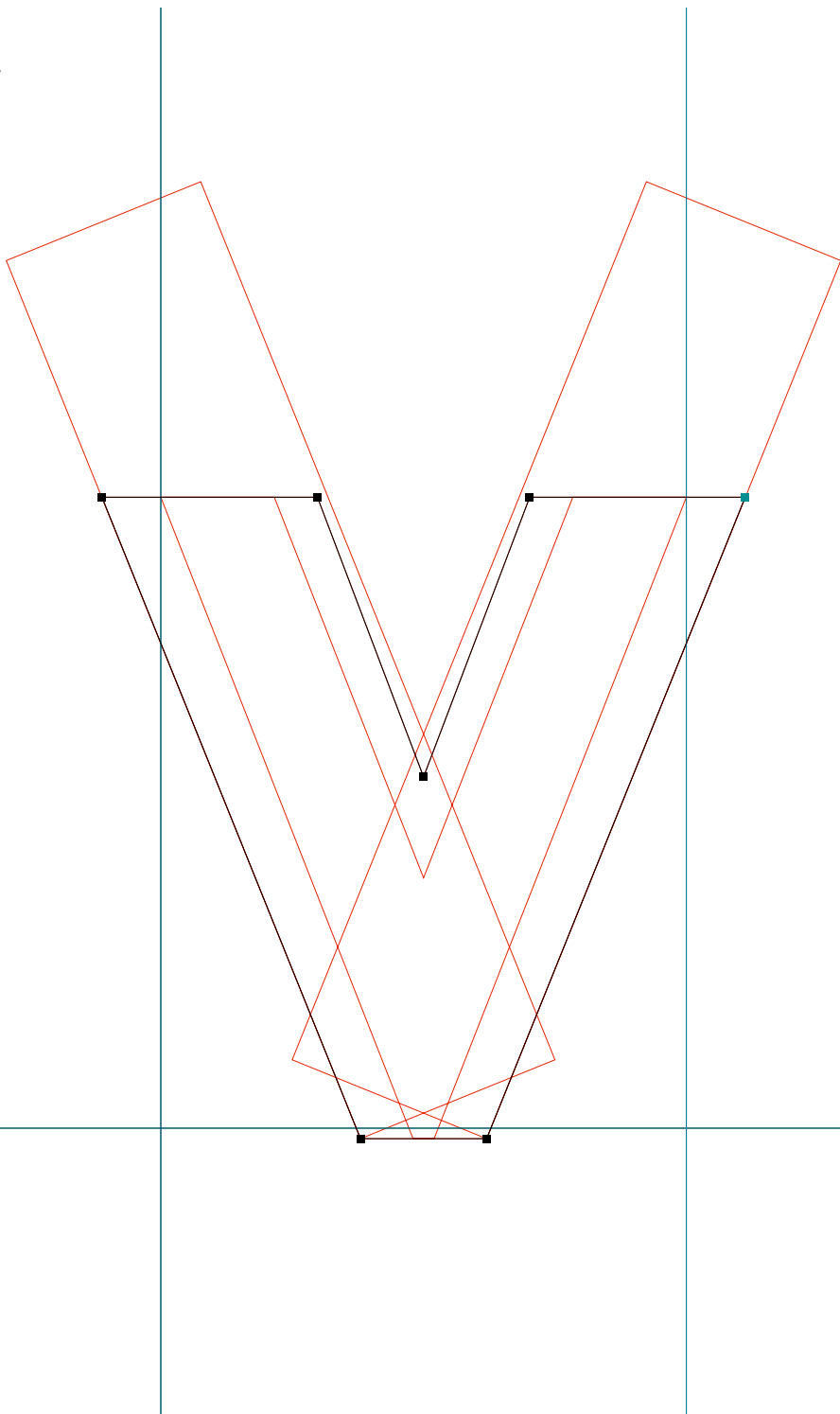

**BASE 9 & 12**

.....  
BaseTwelve SansB | y | RoboFog Sketches | 1995 | Emigre Fonts

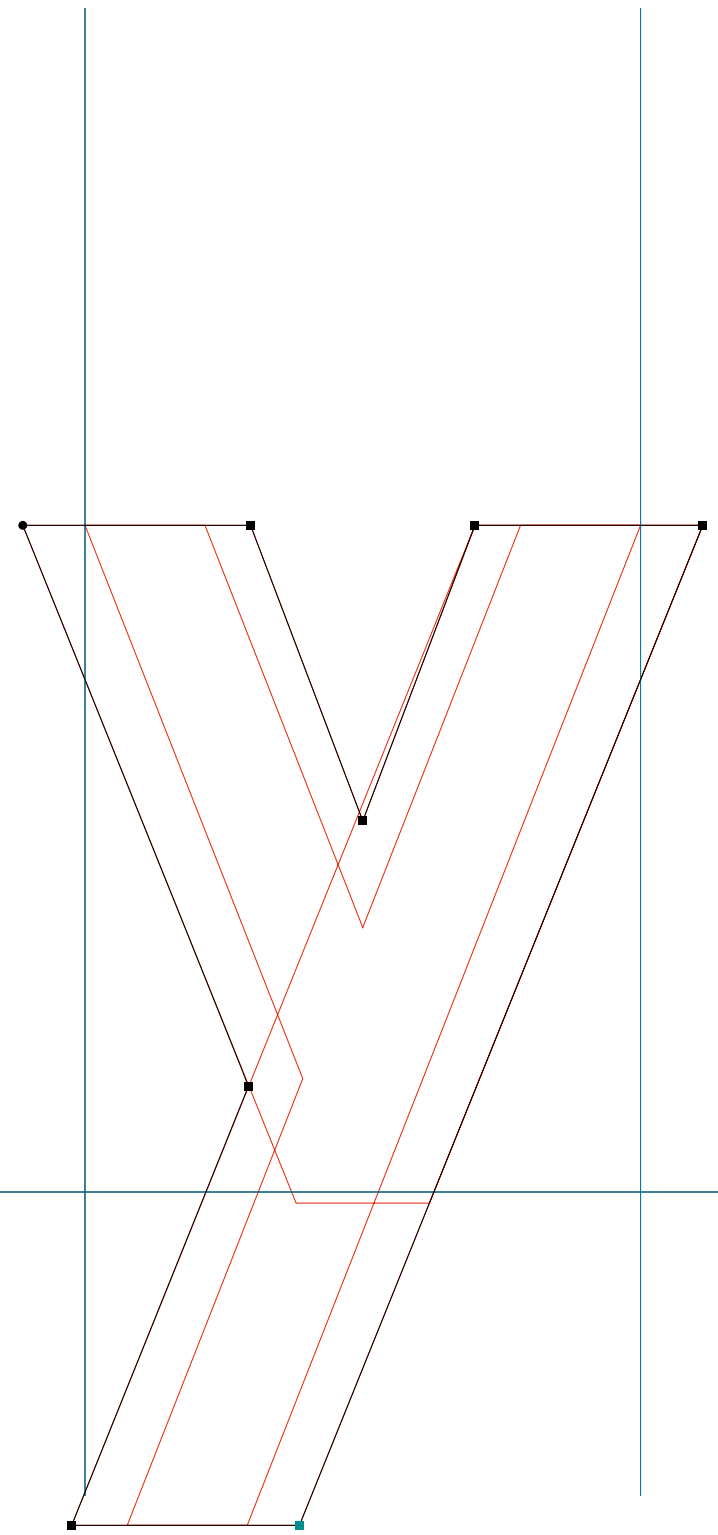

**BASE 9 & 12**

.....  
BaseTwelve SansB | z | RoboFog Sketches | 1995 | Emigre Fonts

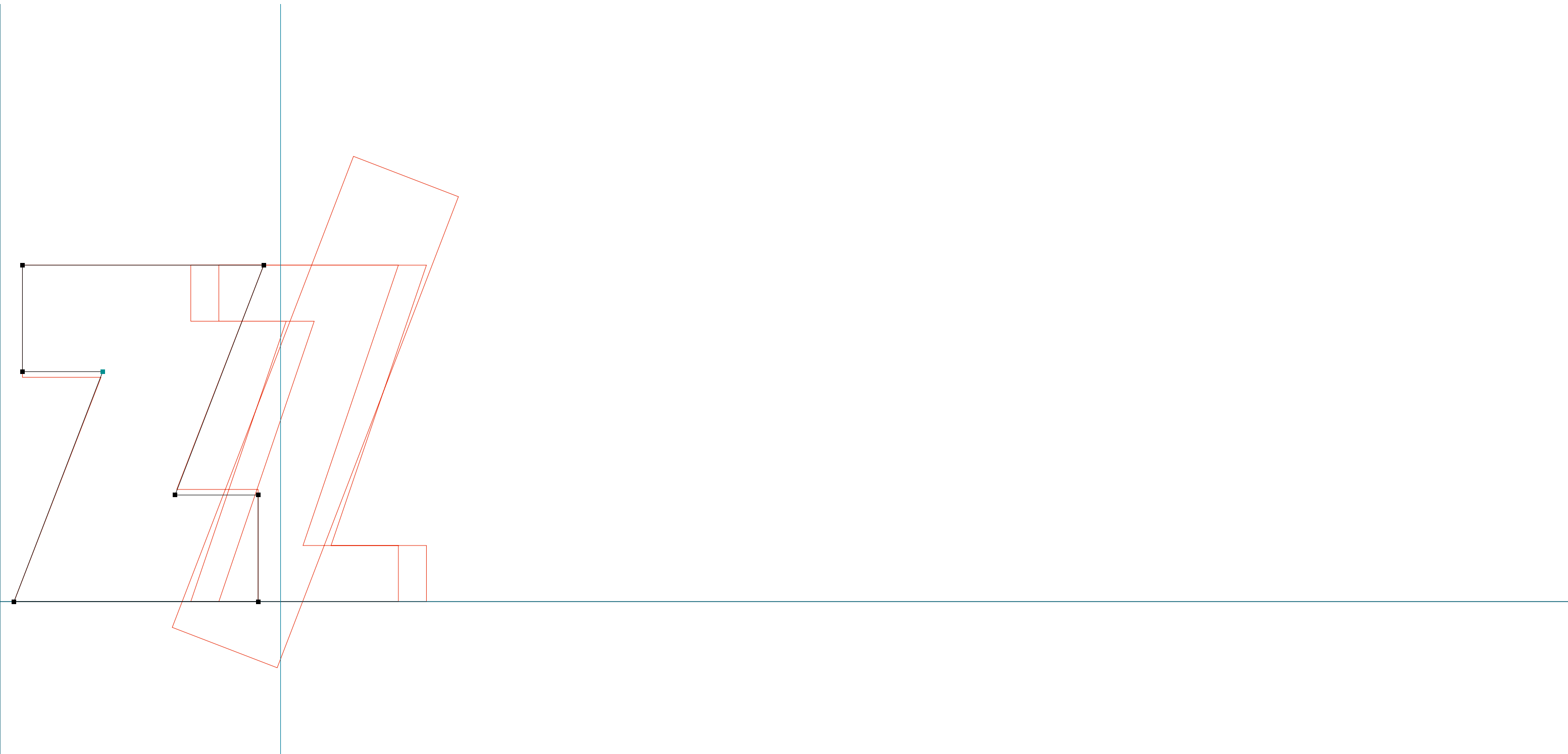

**BASE 9 & 12**

BaseTwelve SansB | section | RoboFog Sketches | 1995 | Emigre Fonts

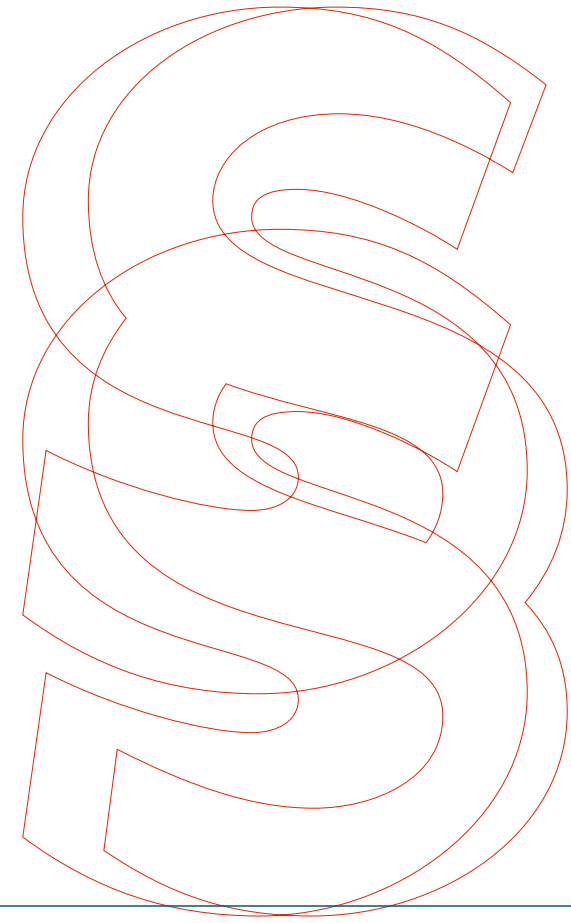
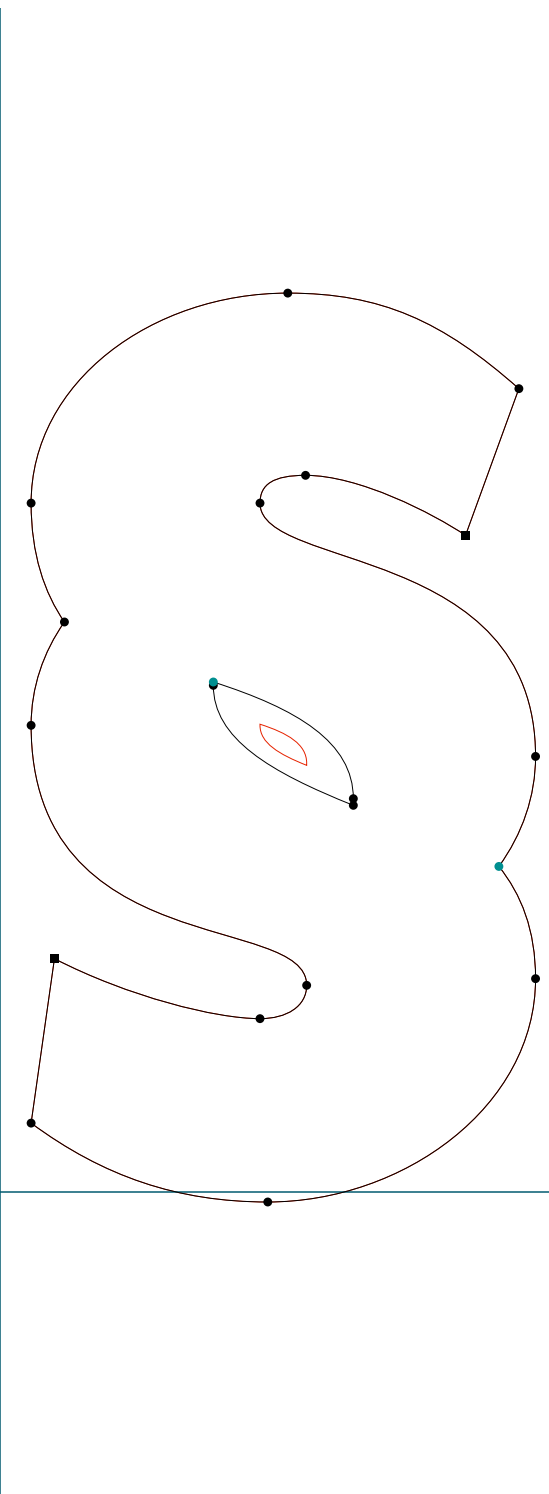

**BASE 9 & 12**

.....  
BaseTwelve SansB | AE | RoboFog Sketches | 1995 | Emigre Fonts

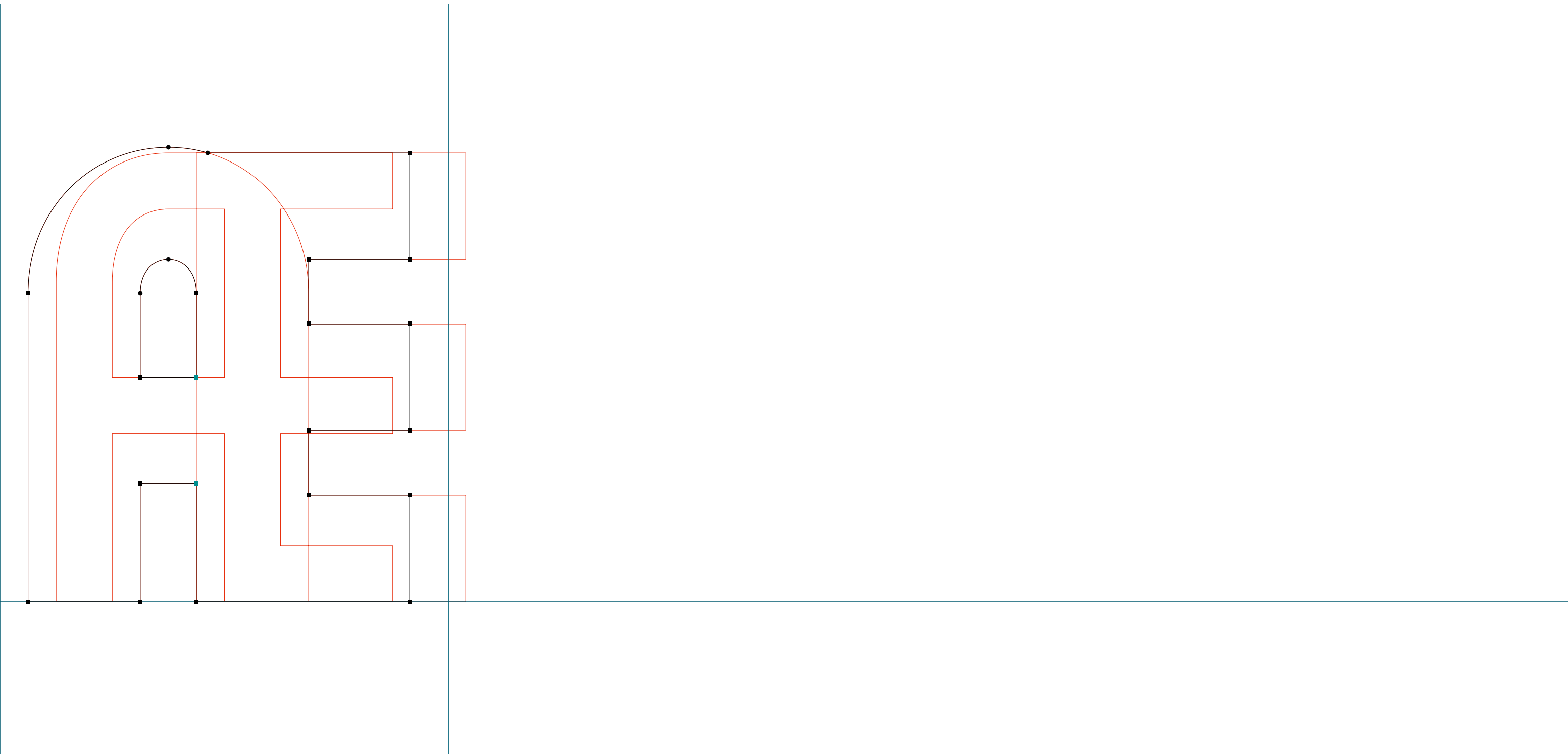

**BASE 9 & 12**

.....  
BaseTwelve SansB | Omega | RoboFog Sketches | 1995 | Emigre Fonts

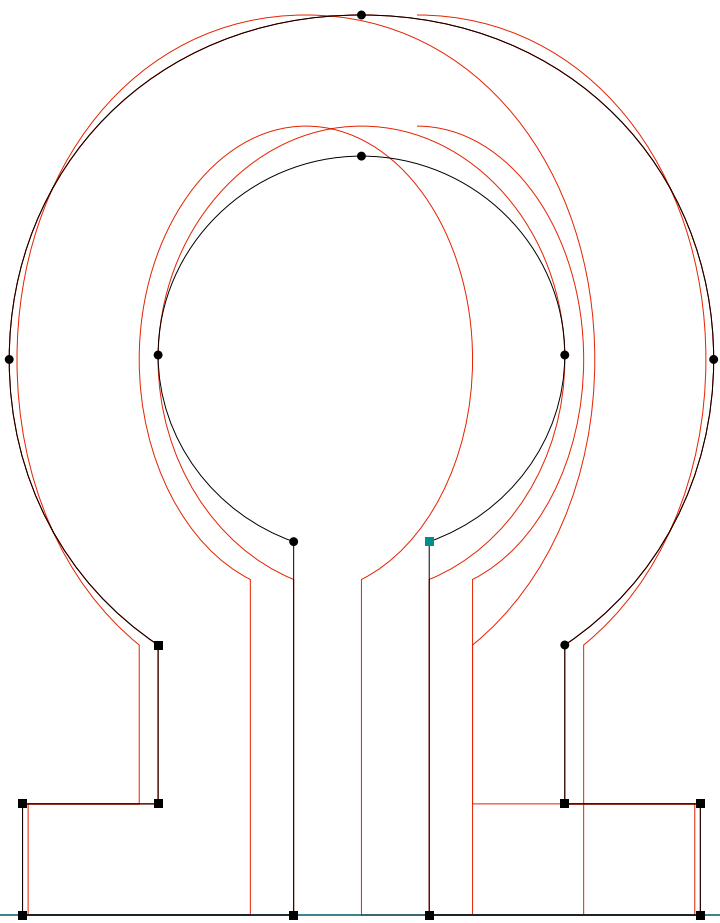



**BASE 9 & 12**

BaseTwelve SansB | daggerdbl | RoboFog Sketches | 1995 | Emigre Fonts

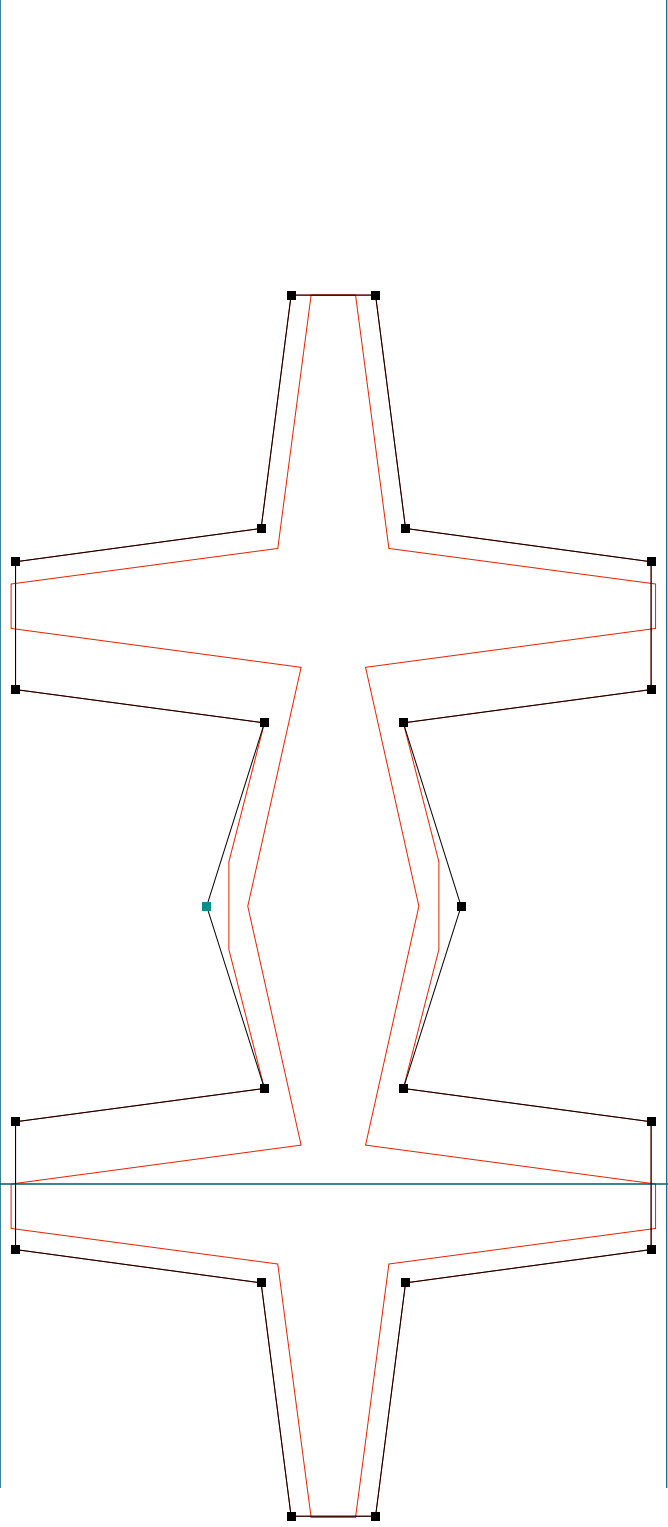

**BASE 9 & 12**

.....  
BaseTwelve SansSCB | quotedbl | RoboFog Sketches | 1995 | Emigre Fonts

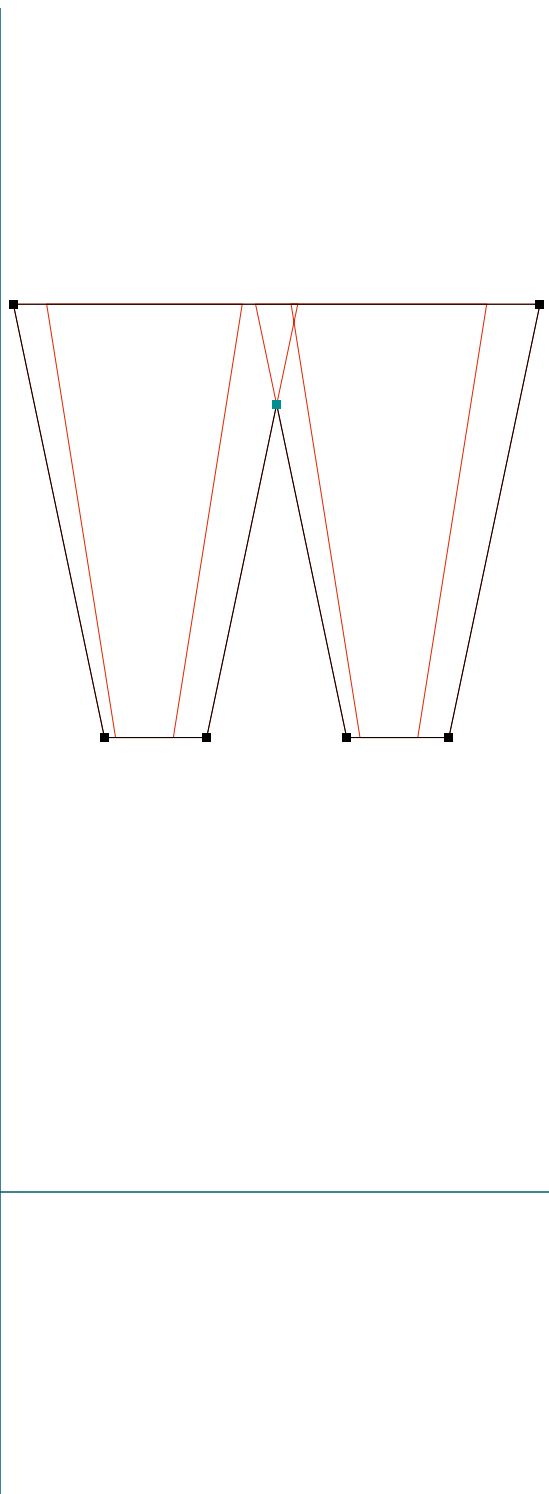

**BASE 9 & 12**

.....  
BaseTwelve SansSCB | two | RoboFog Sketches | 1995 | Emigre Fonts

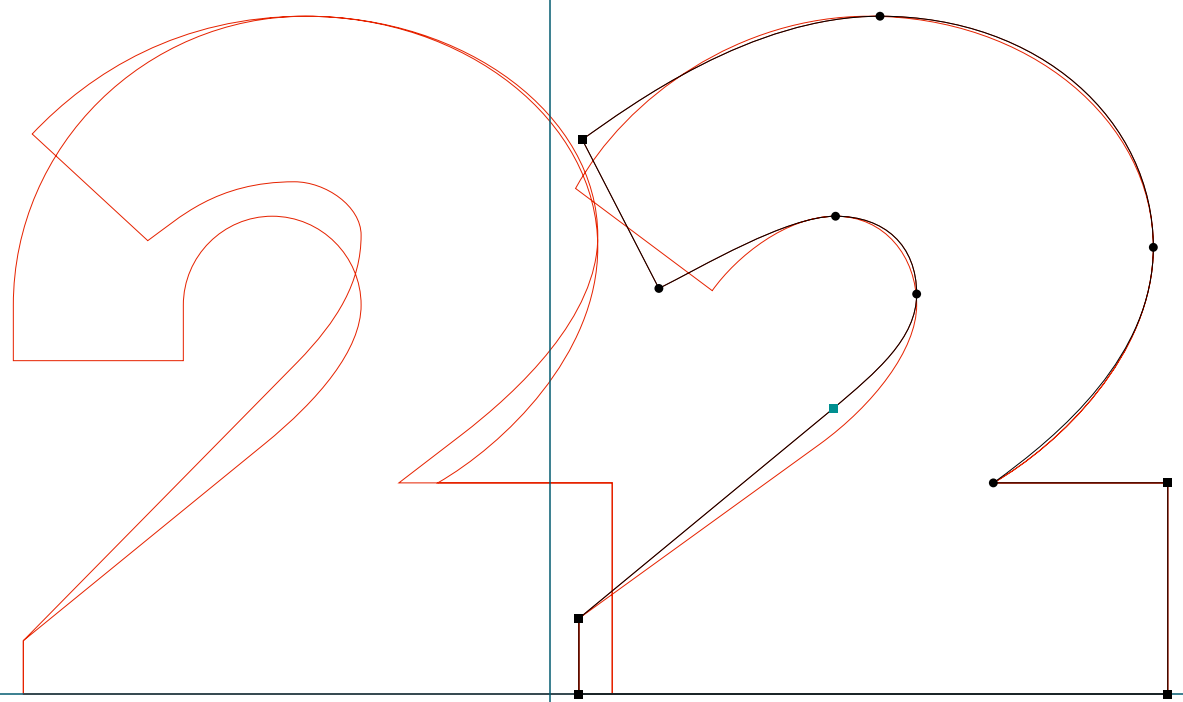

**BASE 9 & 12**

BaseTwelve SansSCB | three | RoboFog Sketches | 1995 | Emigre Fonts

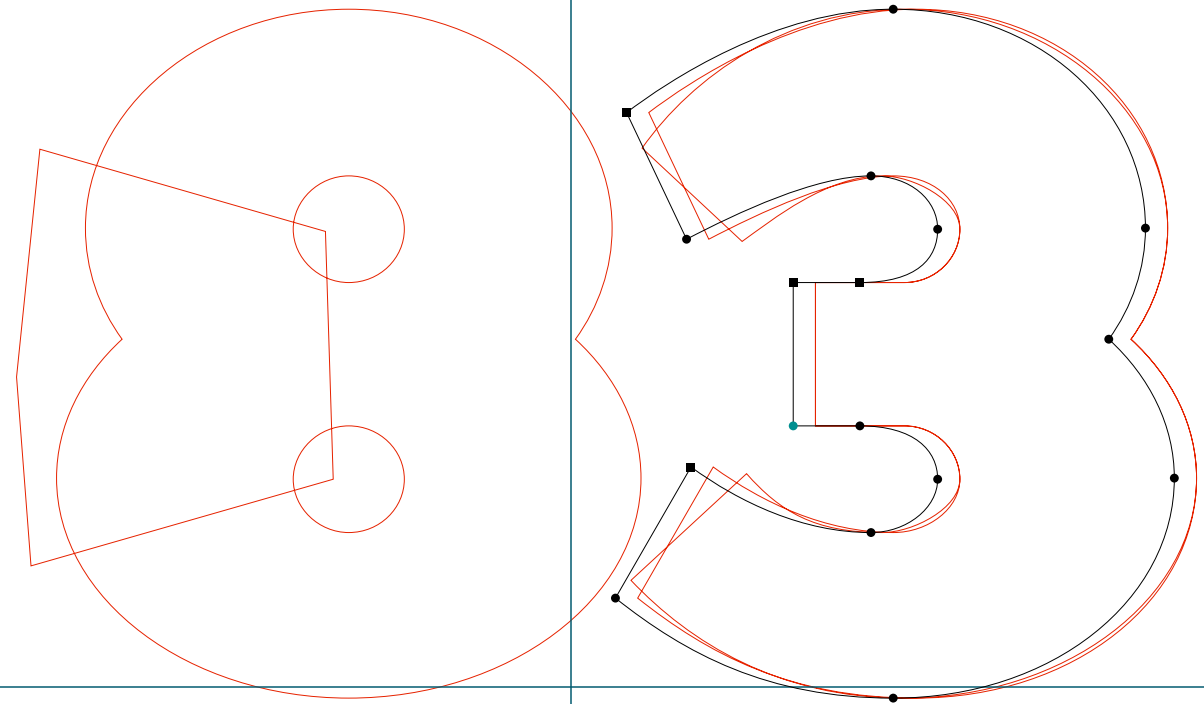

**BASE 9 & 12**

.....  
BaseTwelve SansSCB | eight | RoboFog Sketches | 1995 | Emigre Fonts

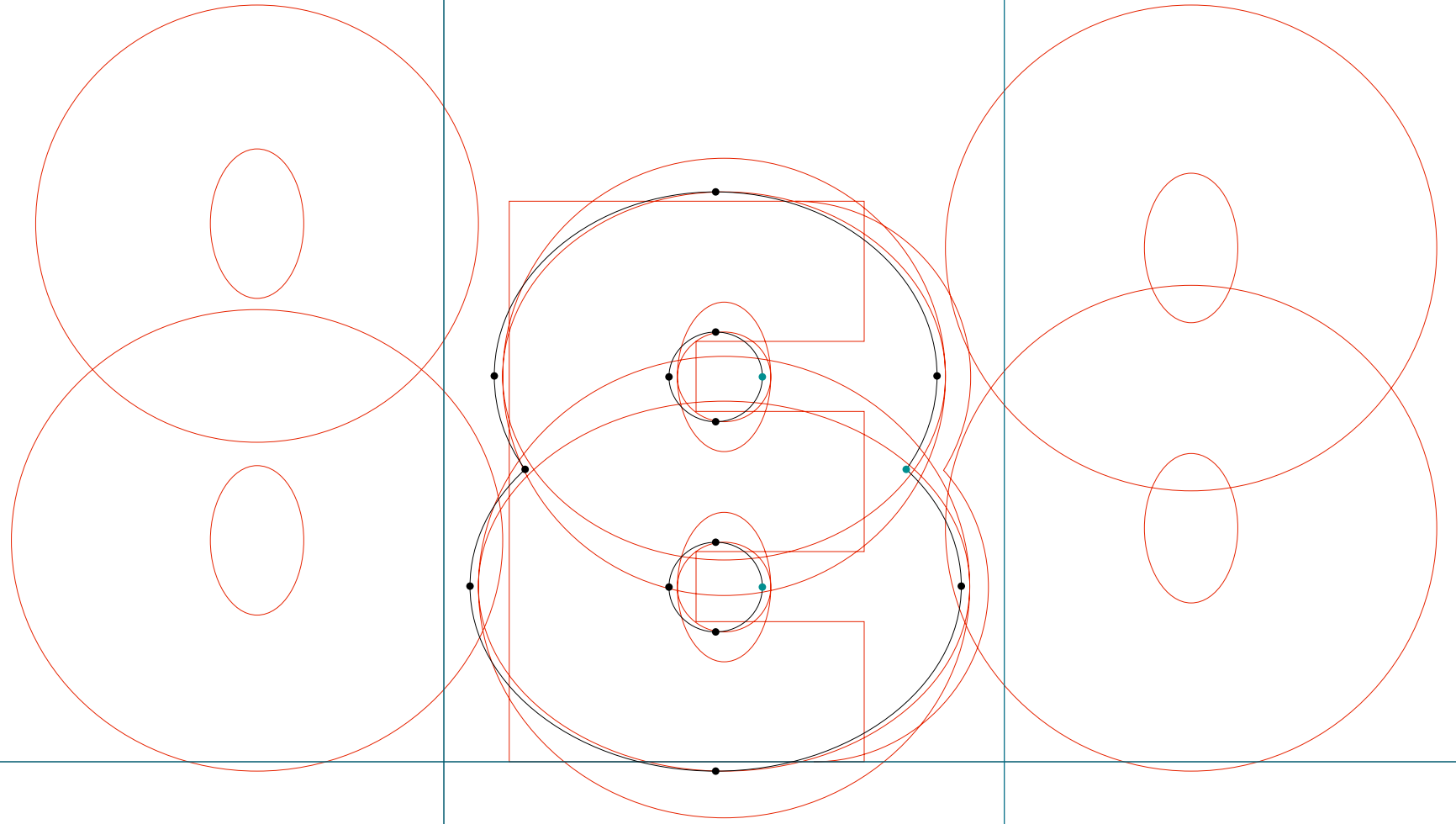

**BASE 9 & 12**

.....  
BaseTwelve SansSCB | B | RoboFog Sketches | 1995 | Emigre Fonts

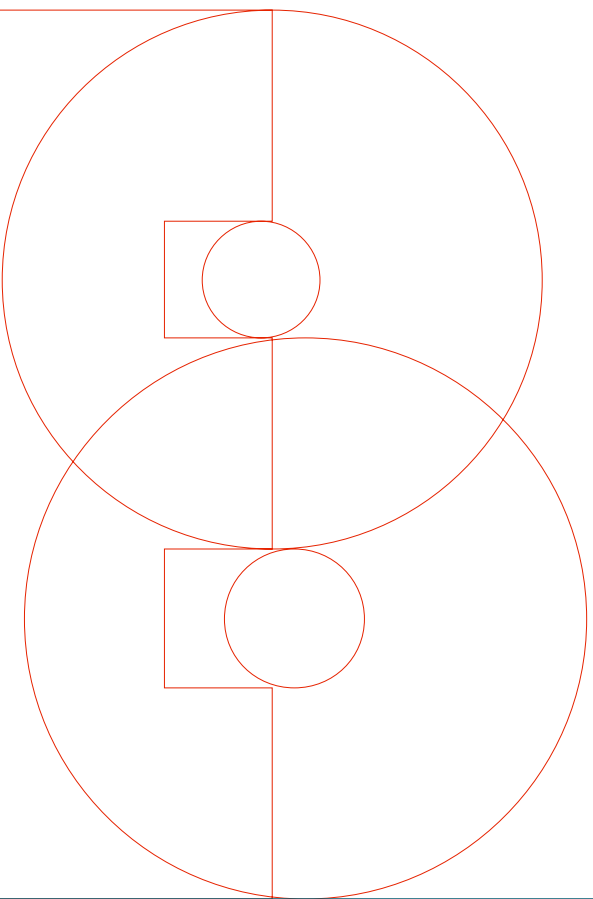
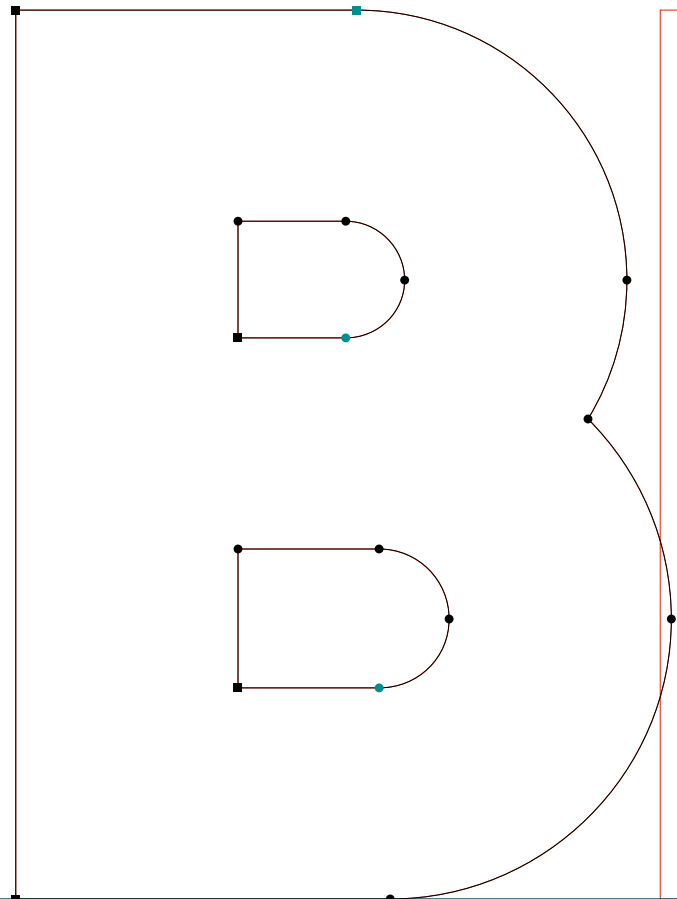
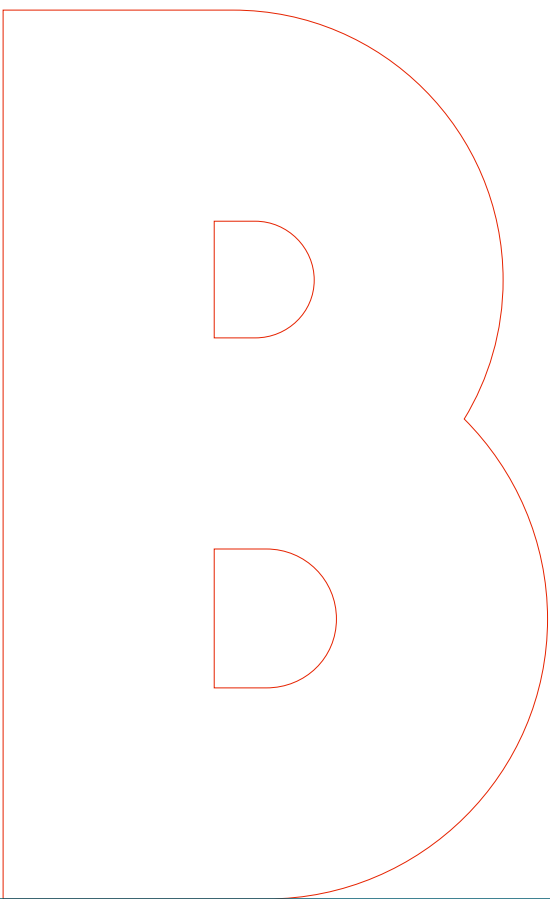

**BASE 9 & 12**

.....  
BaseTwelve SansSCB | C | RoboFog Sketches | 1995 | Emigre Fonts

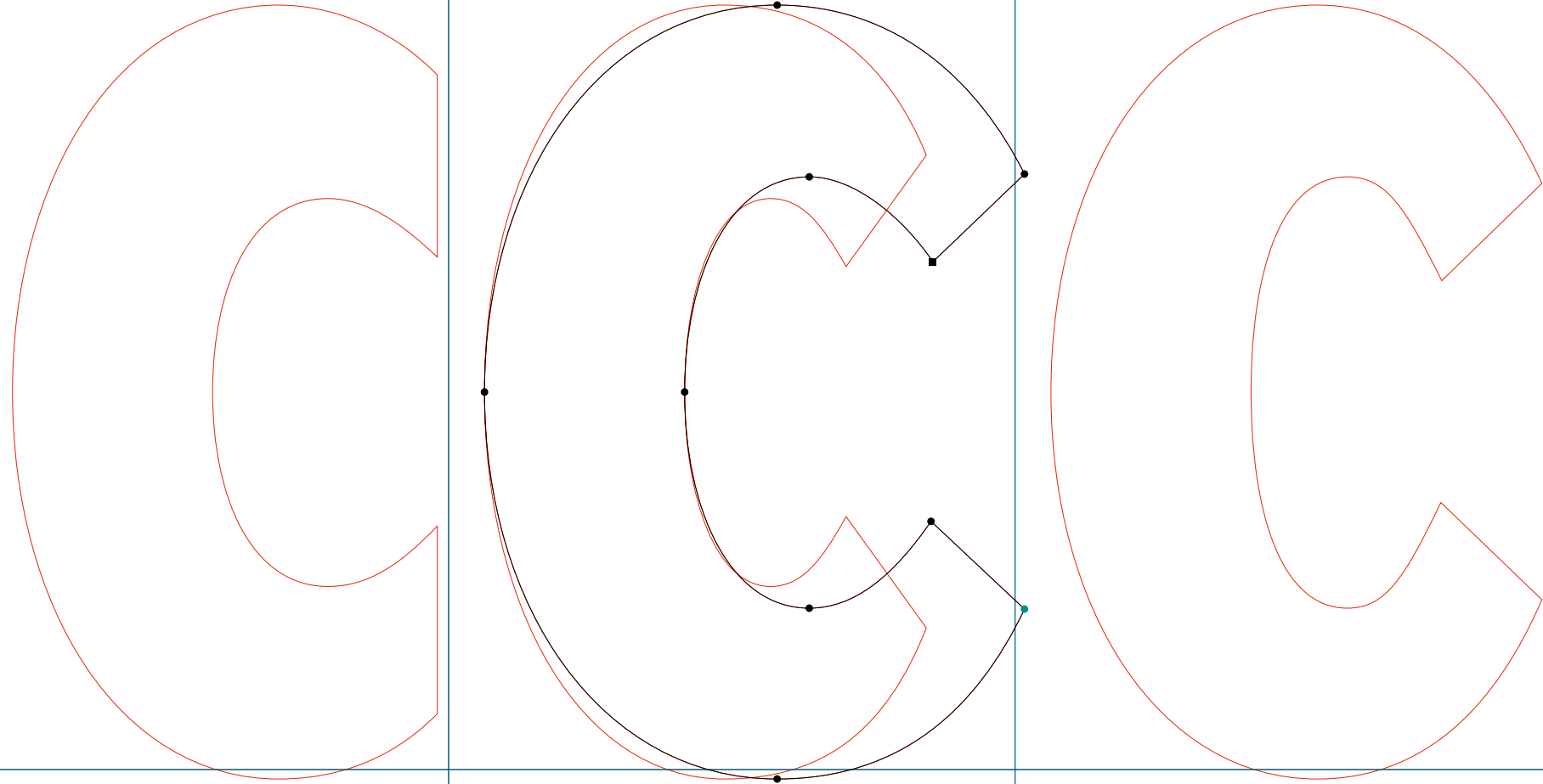

**BASE 9 & 12**

.....  
BaseTwelve SansSCB | D | RoboFog Sketches | 1995 | Emigre Fonts

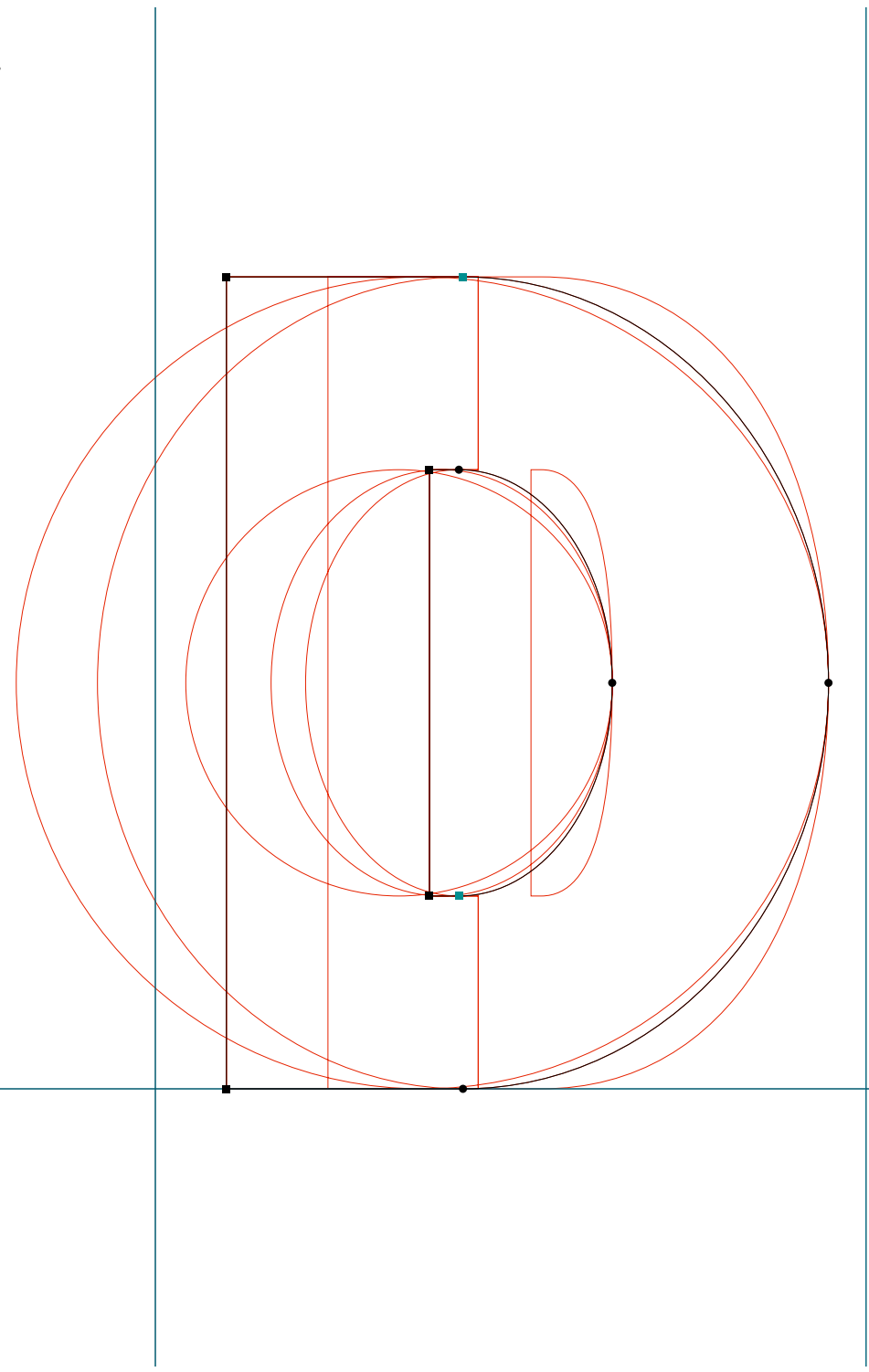



**BASE 9 & 12**

.....  
BaseTwelve SansSCB | F | RoboFog Sketches | 1995 | Emigre Fonts

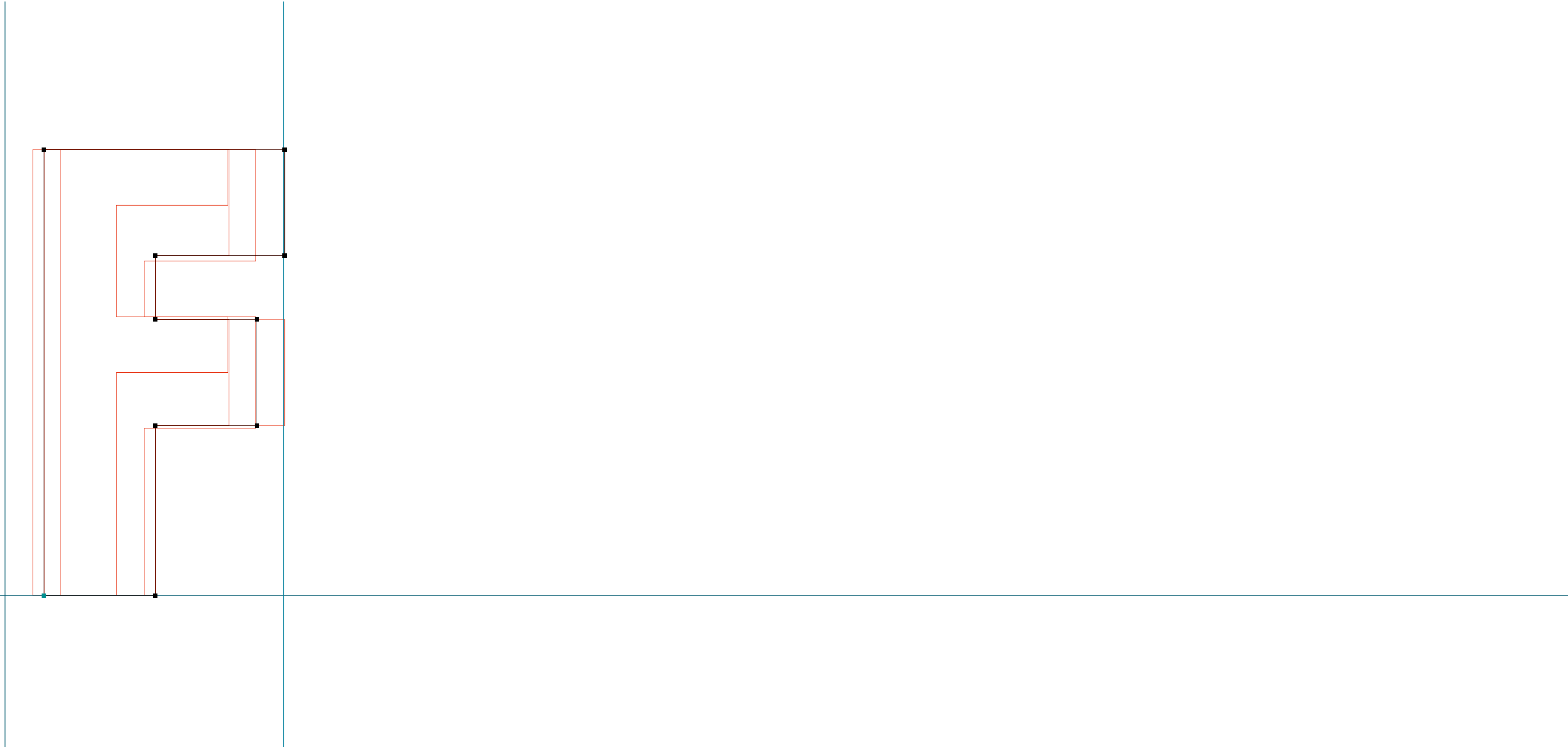

**BASE 9 & 12**

.....  
BaseTwelve SansSCB | G | RoboFog Sketches | 1995 | Emigre Fonts

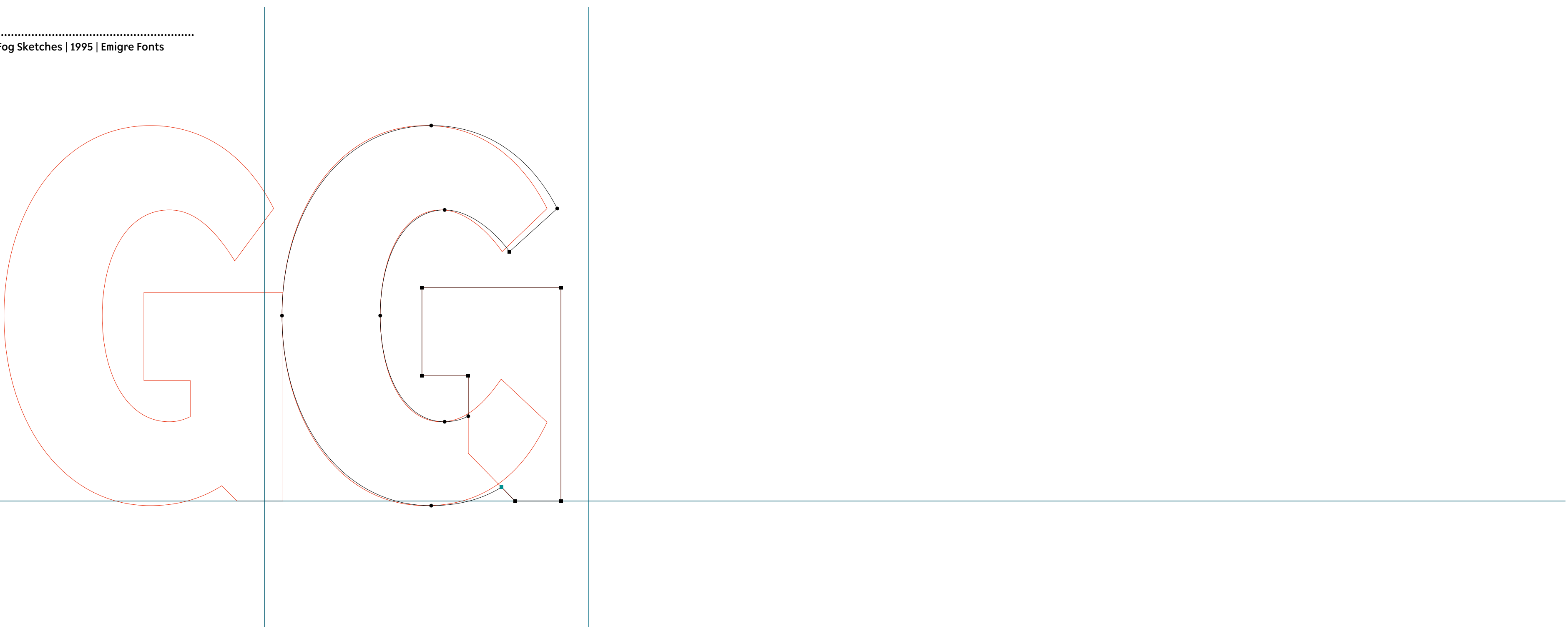

**BASE 9 & 12**

.....  
BaseTwelve SansSCB | I | RoboFog Sketches | 1995 | Emigre Fonts

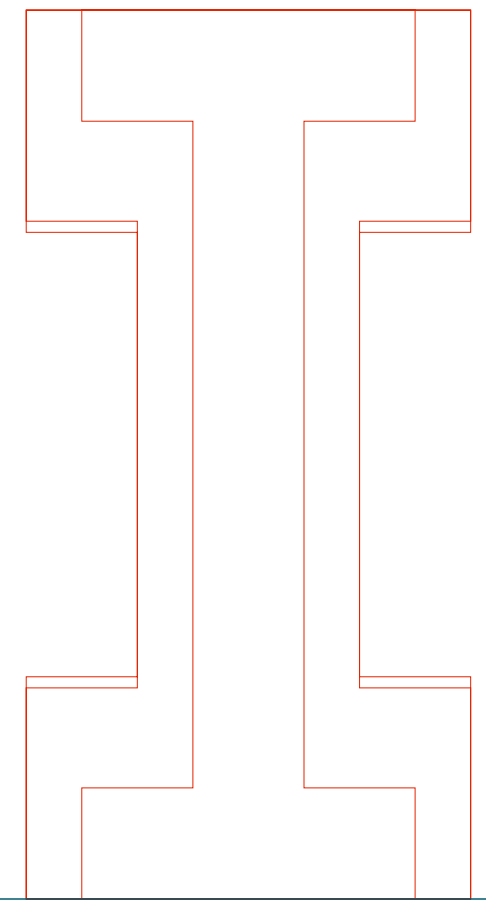
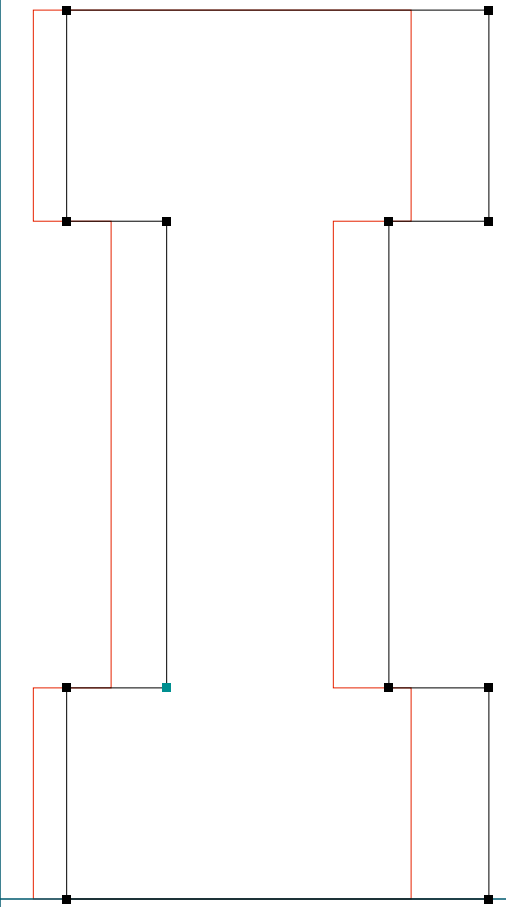

**BASE 9 & 12**

.....  
BaseTwelve SansSCB | J | RoboFog Sketches | 1995 | Emigre Fonts

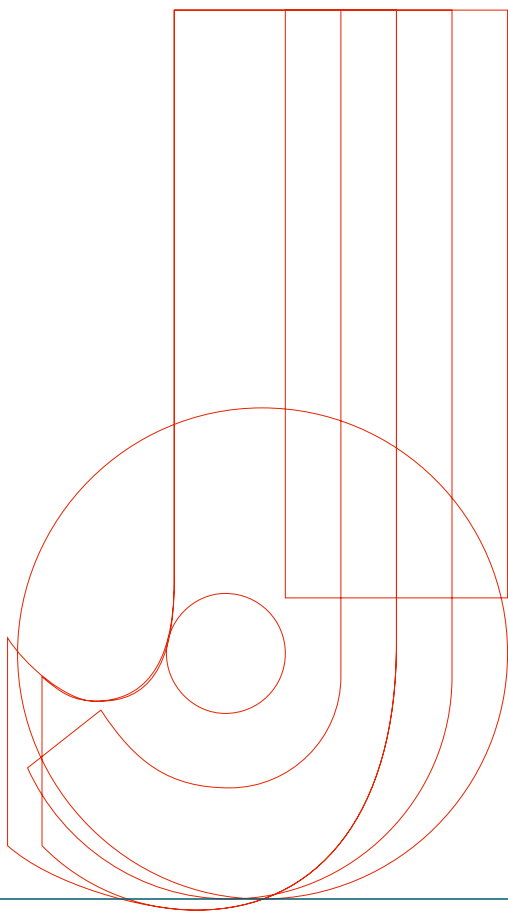
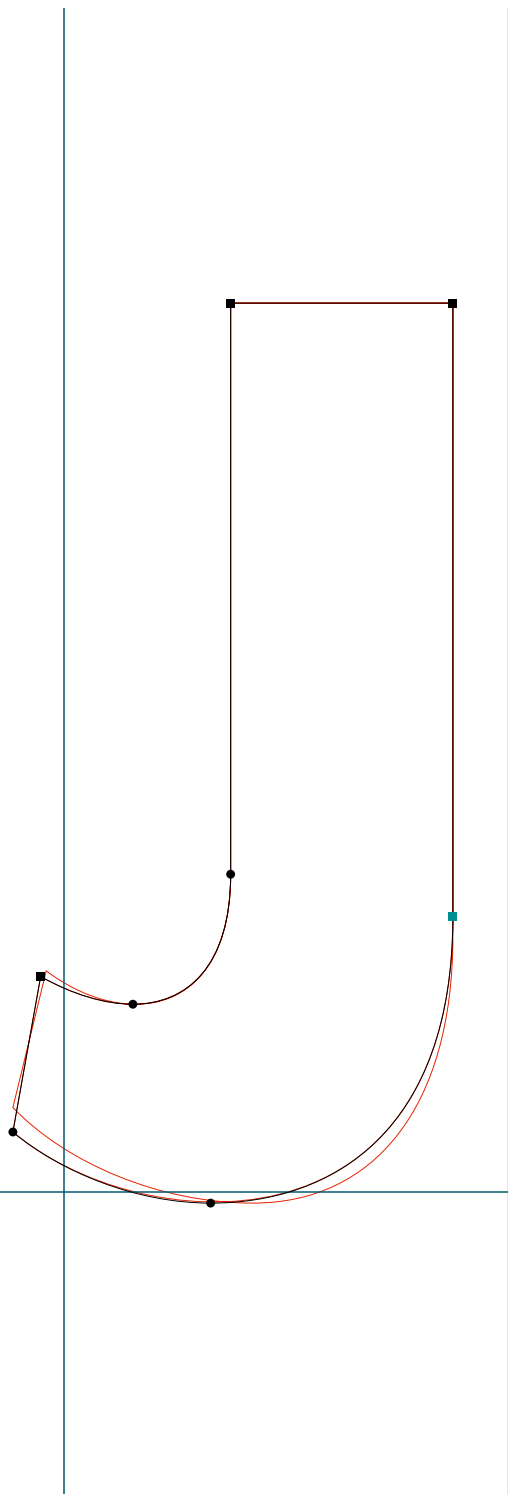

**BASE 9 & 12**

.....  
BaseTwelve SansSCB | K | RoboFog Sketches | 1995 | Emigre Fonts

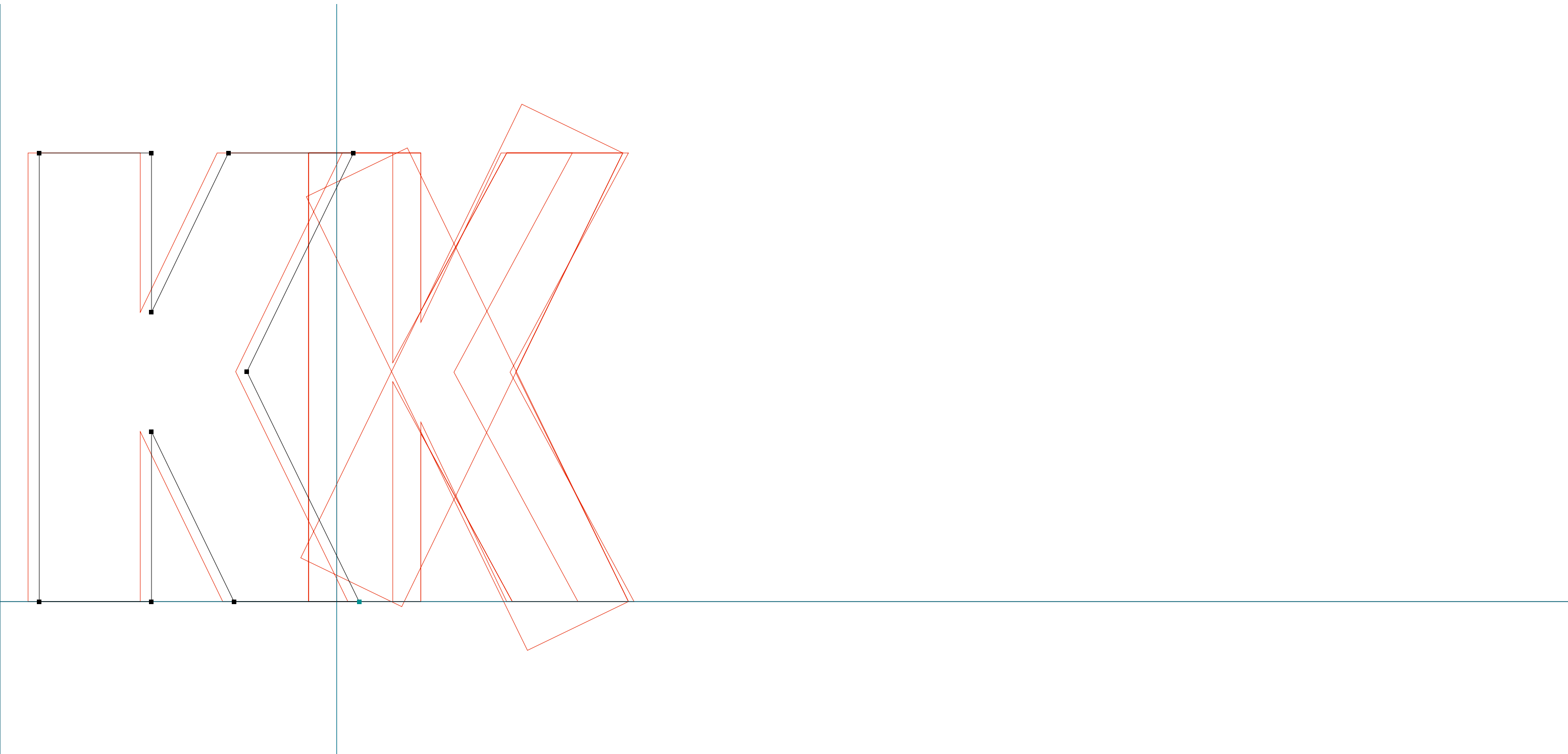

**BASE 9 & 12**

.....  
BaseTwelve SansSCB | M | RoboFog Sketches | 1995 | Emigre Fonts

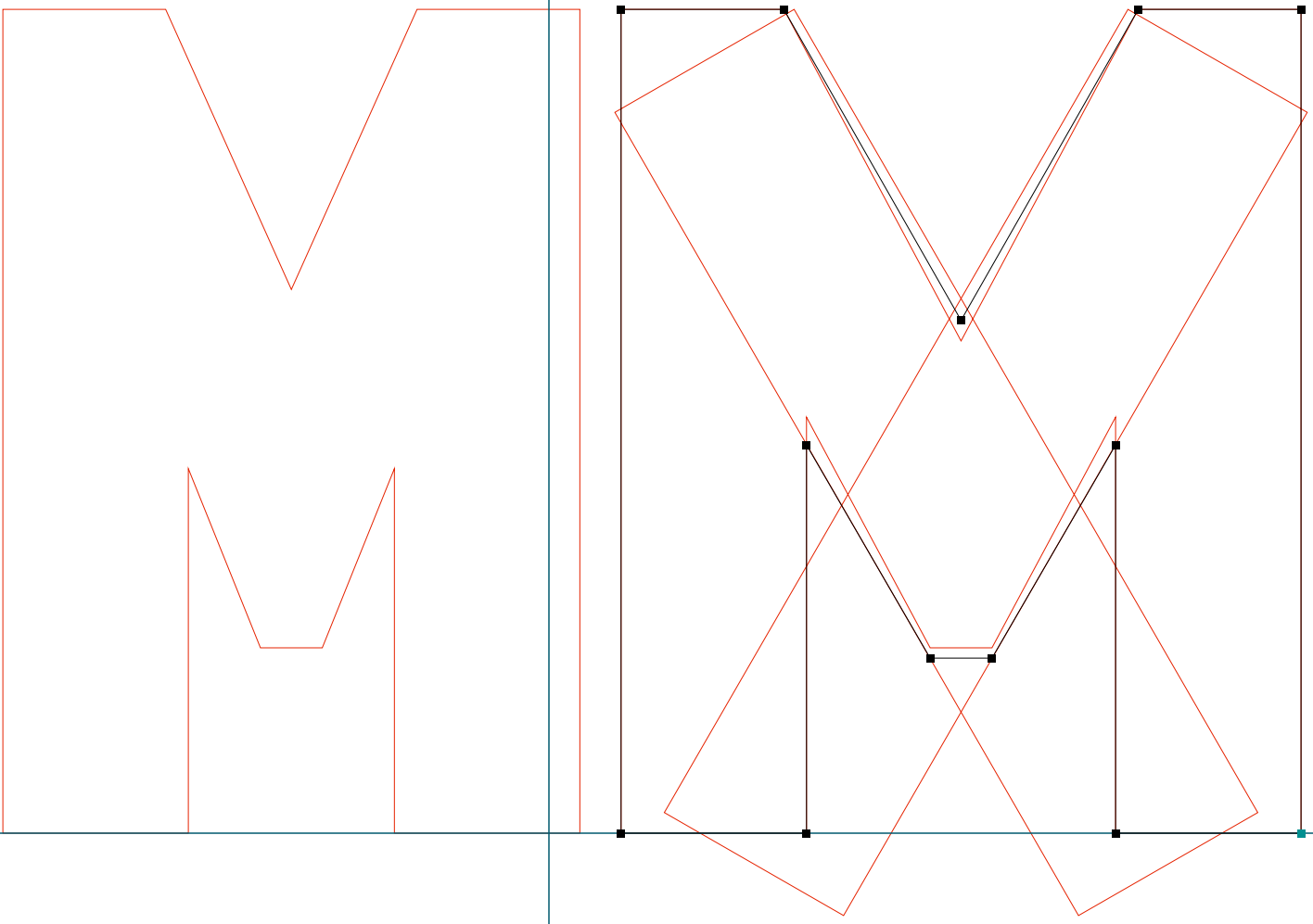

**BASE 9 & 12**

.....  
BaseTwelve SansSCB | N | RoboFog Sketches | 1995 | Emigre Fonts

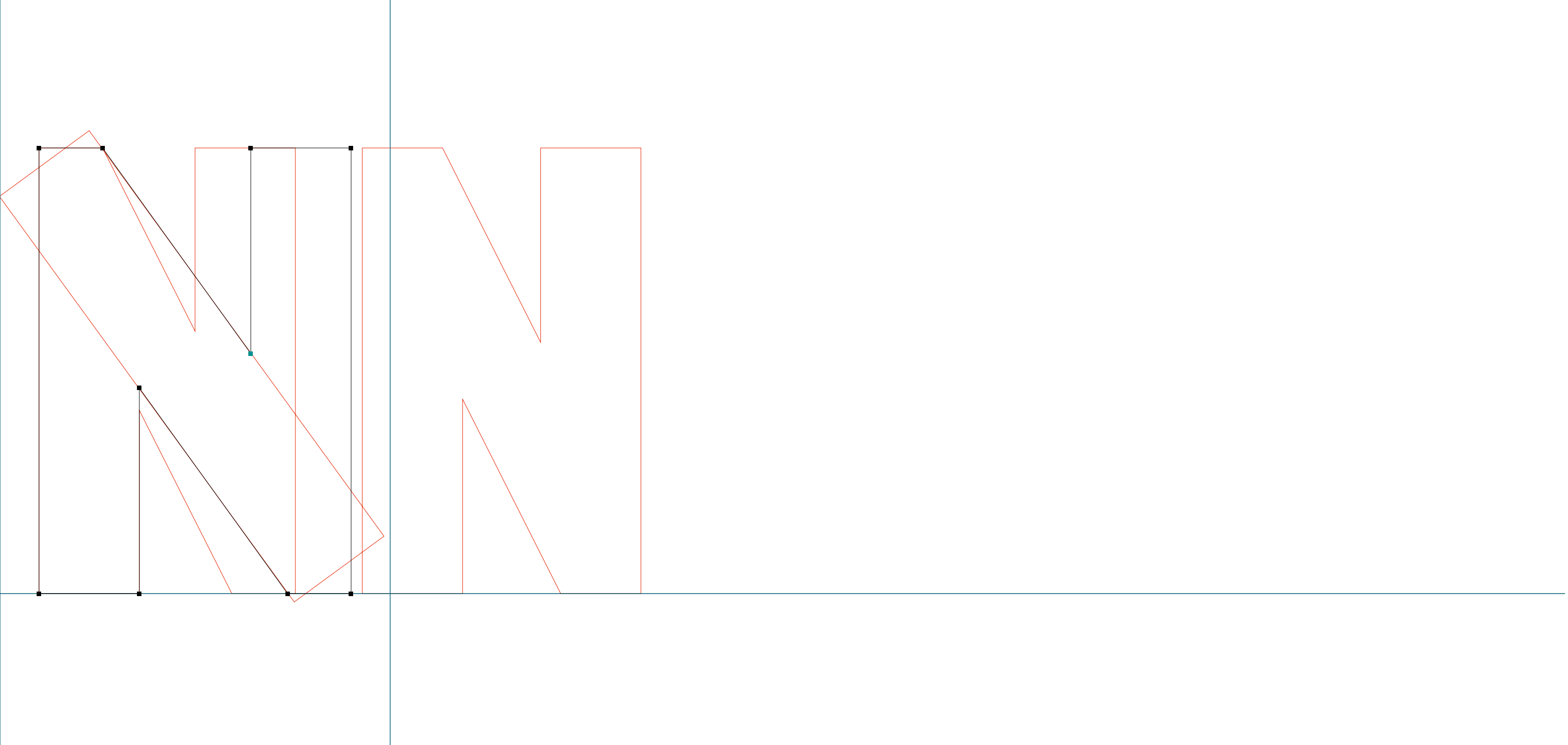

**BASE 9 & 12**

.....  
BaseTwelve SansSCB | P | RoboFog Sketches | 1995 | Emigre Fonts

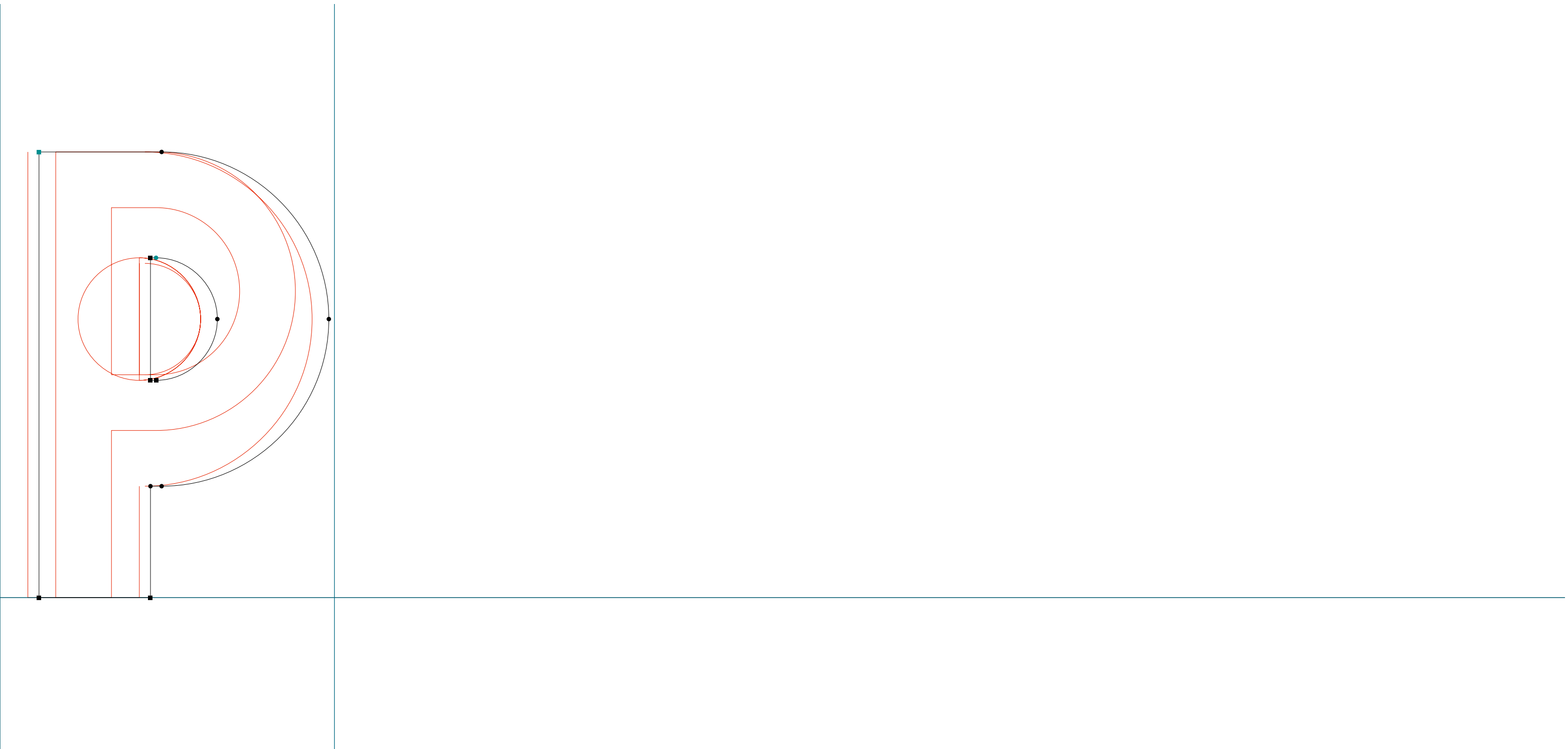



**BASE 9 & 12**

.....  
BaseTwelve SansSCB | R | RoboFog Sketches | 1995 | Emigre Fonts

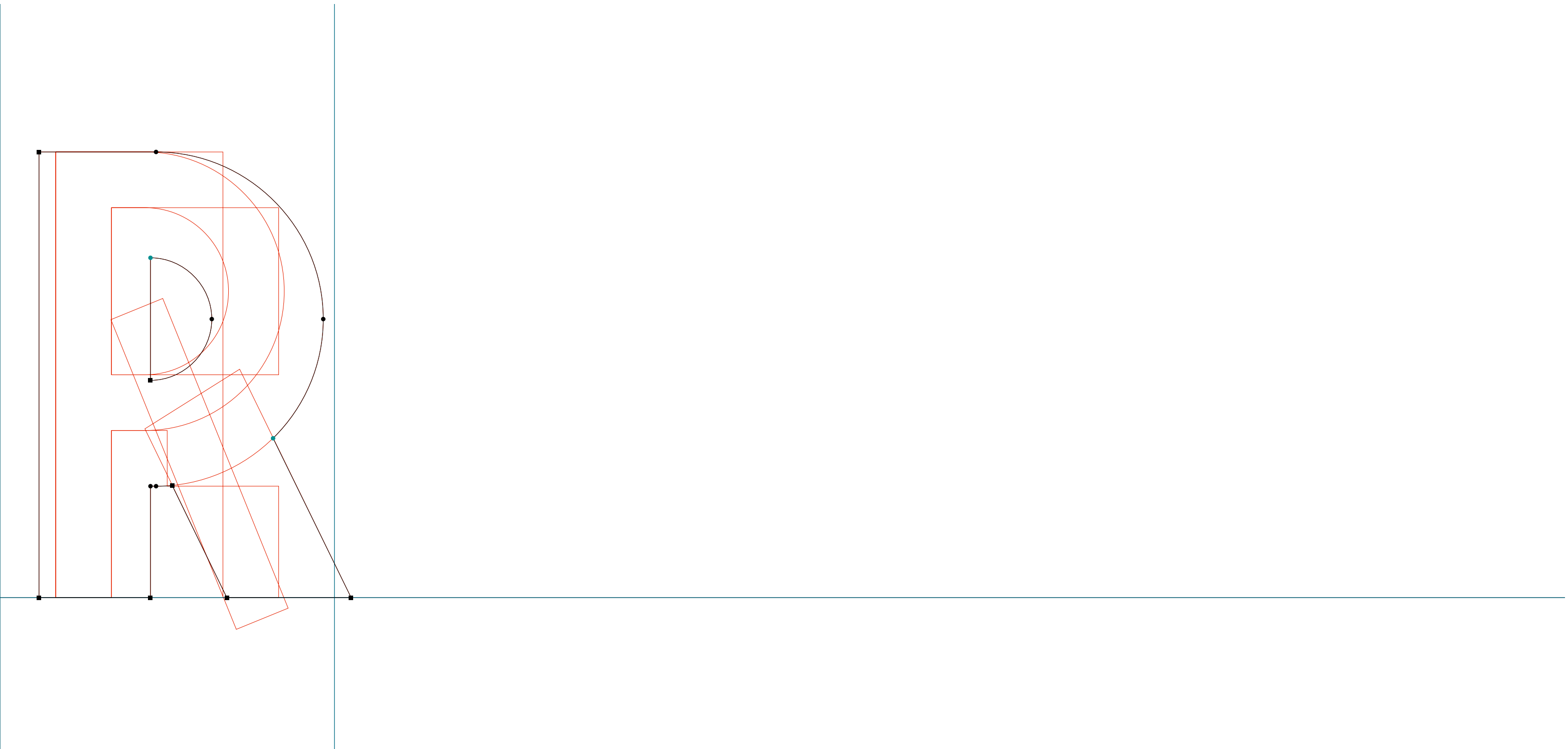

**BASE 9 & 12**

.....  
BaseTwelve SansSCB | S | RoboFog Sketches | 1995 | Emigre Fonts



**BASE 9 & 12**

.....  
BaseTwelve SansSCB | V | RoboFog Sketches | 1995 | Emigre Fonts

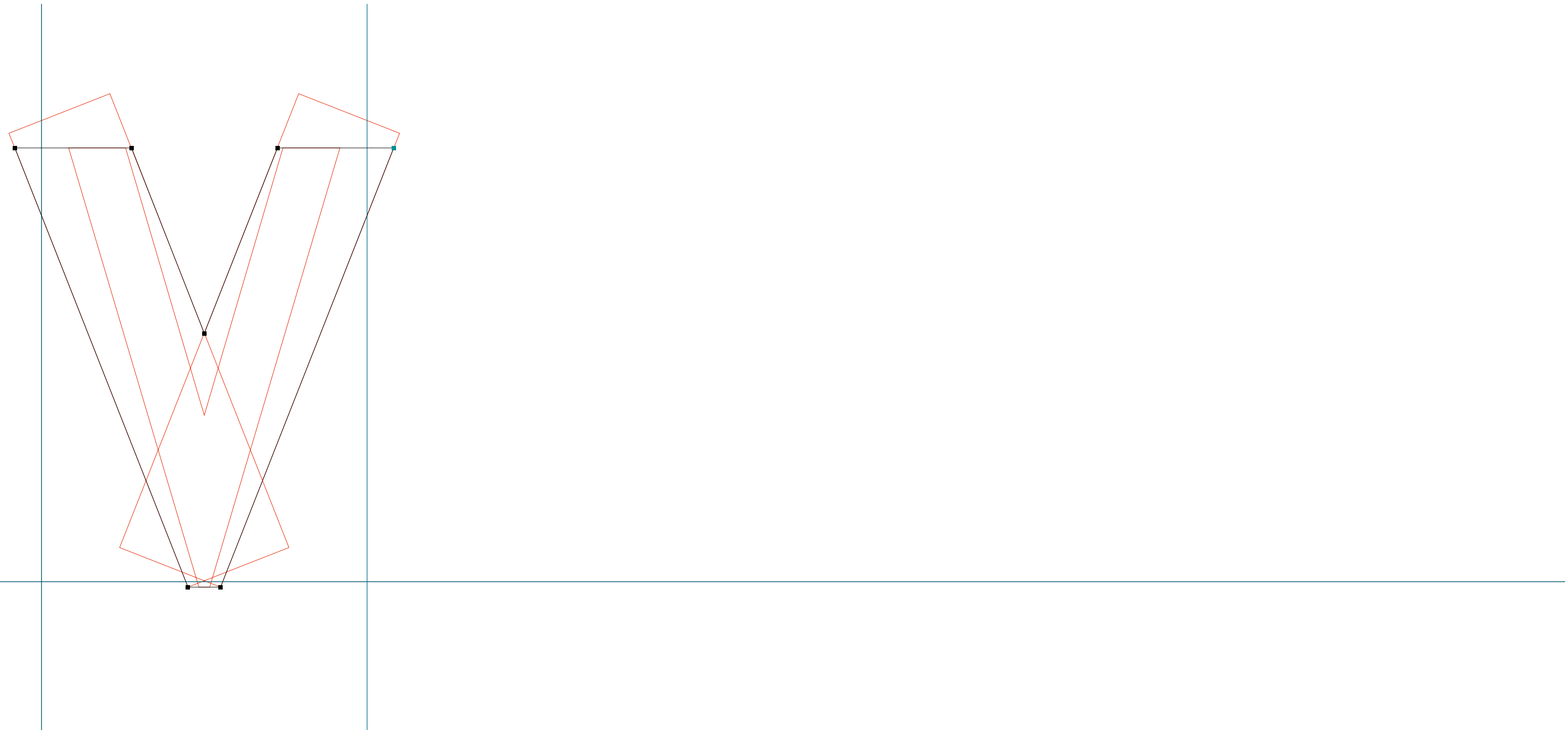

**BASE 9 & 12**

.....  
BaseTwelve SansSCB | X | RoboFog Sketches | 1995 | Emigre Fonts



**BASE 9 & 12**

.....  
BaseTwelve SansSCB | Y | RoboFog Sketches | 1995 | Emigre Fonts

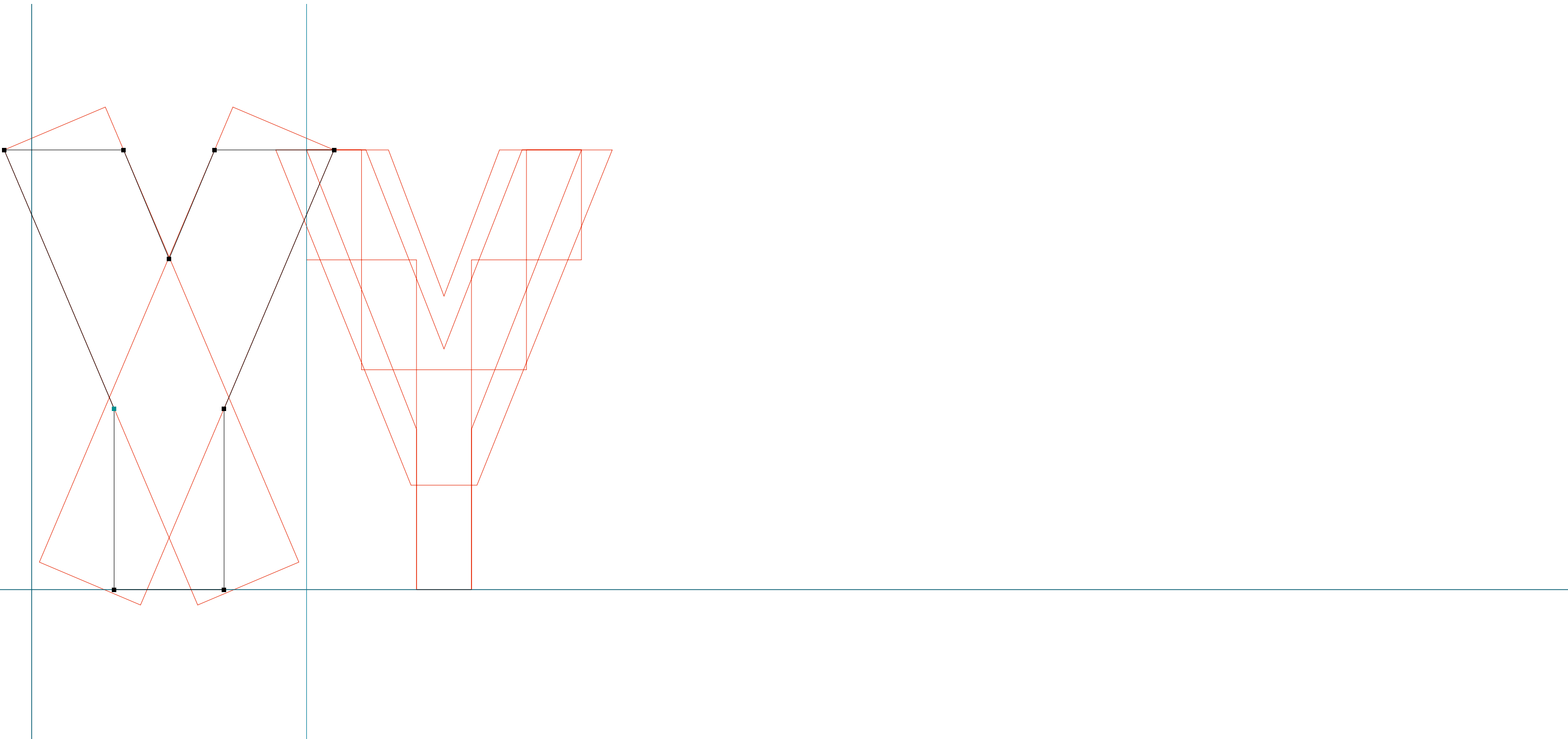

**BASE 9 & 12**

.....  
BaseTwelve SansSCB | d | RoboFog Sketches | 1995 | Emigre Fonts

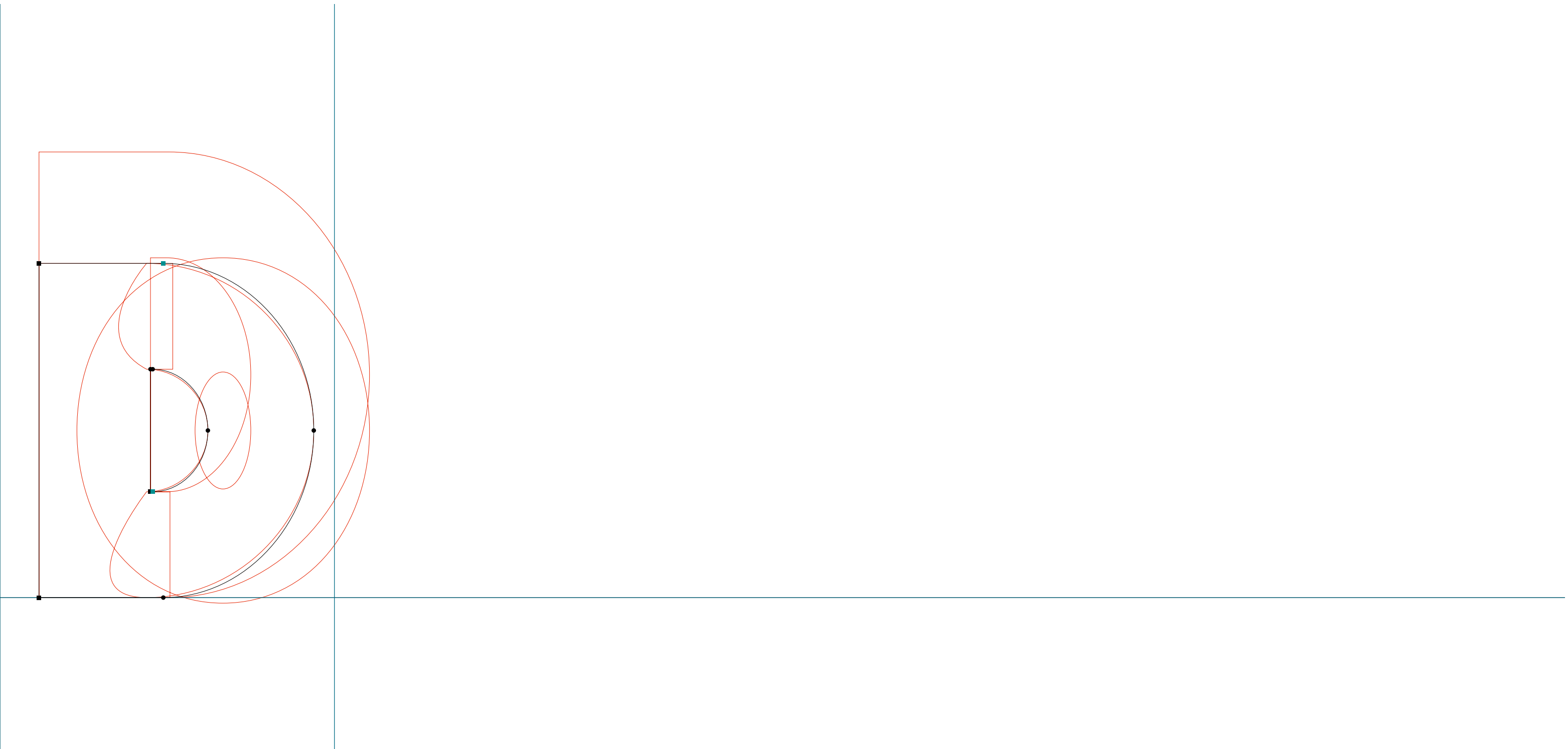

**BASE 9 & 12**

BaseTwelve SansSCB | g | RoboFog Sketches | 1995 | Emigre Fonts

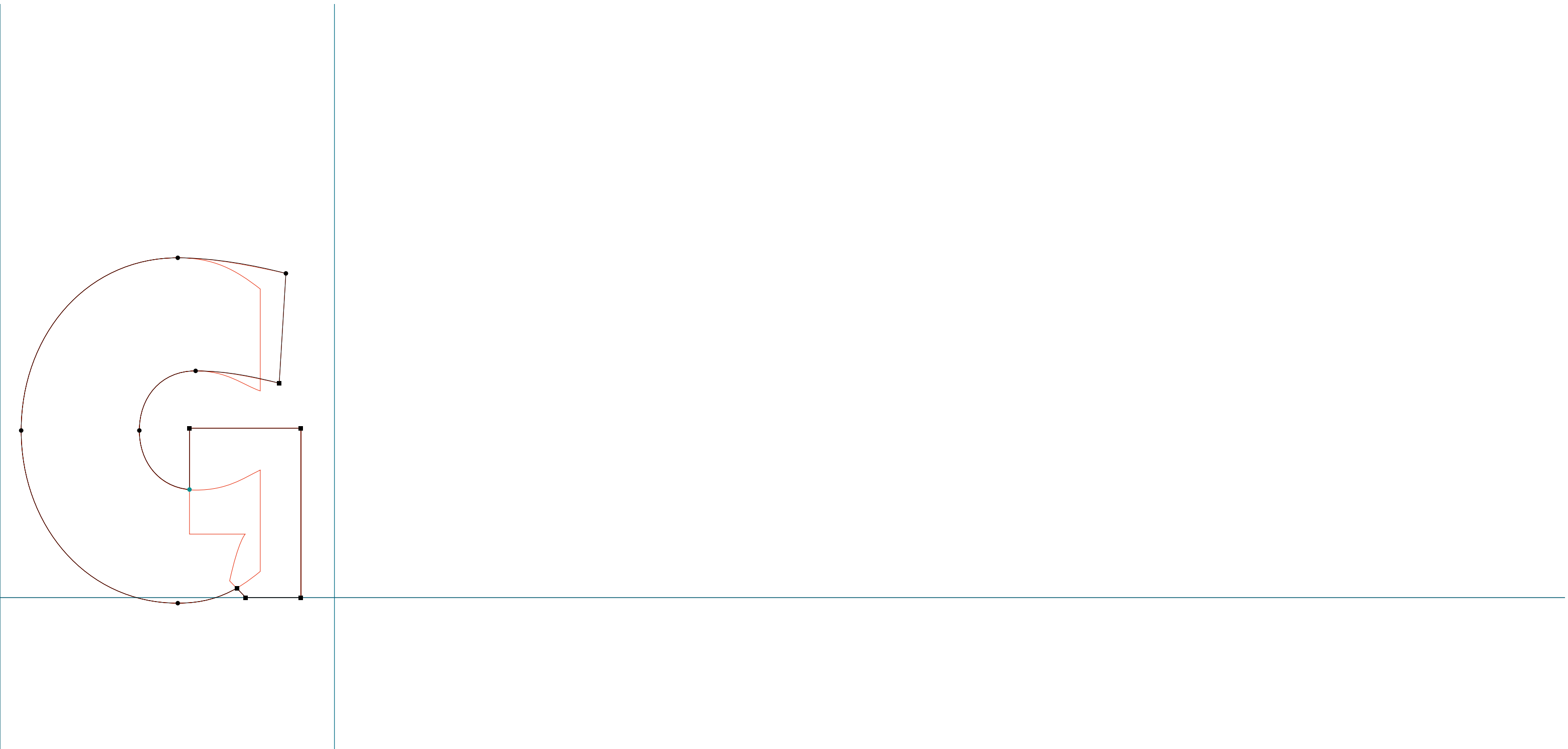

**BASE 9 & 12**

.....  
BaseTwelve SansSCB | p | RoboFog Sketches | 1995 | Emigre Fonts

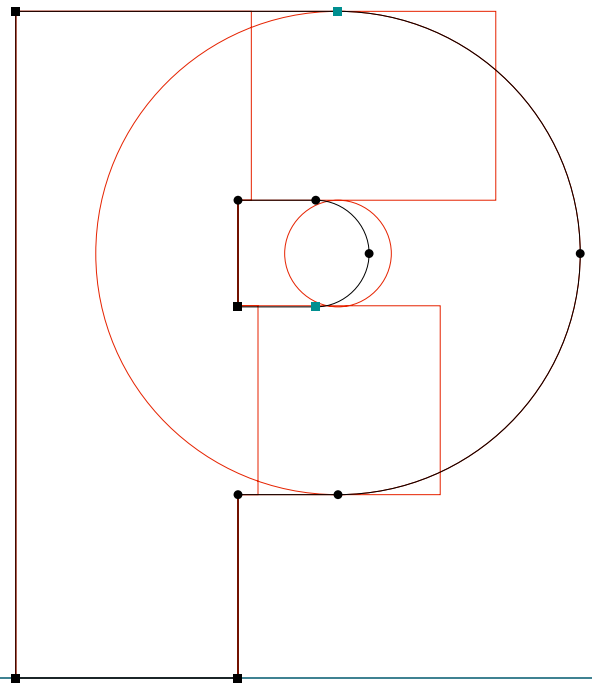



**BASE 9 & 12**

BaseTwelve SansSCB | section | RoboFog Sketches | 1995 | Emigre Fonts

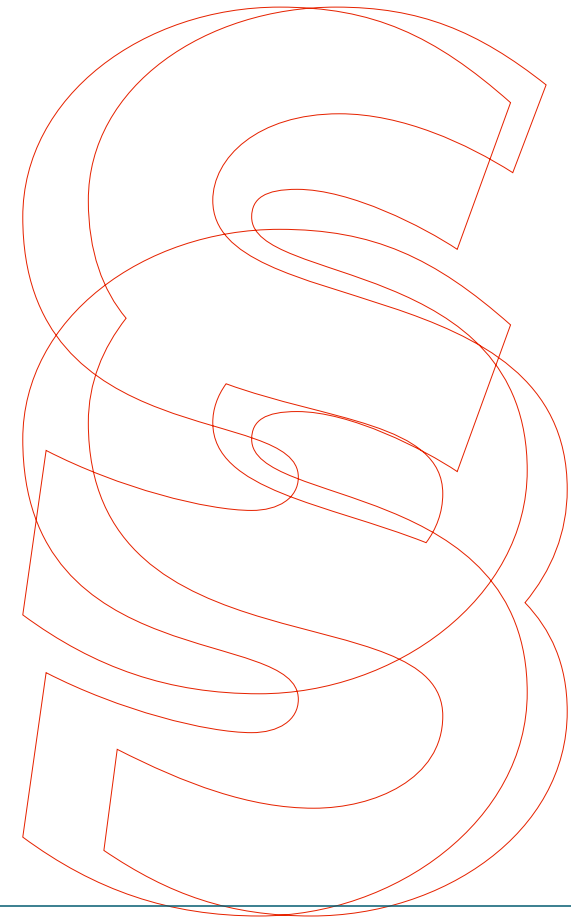
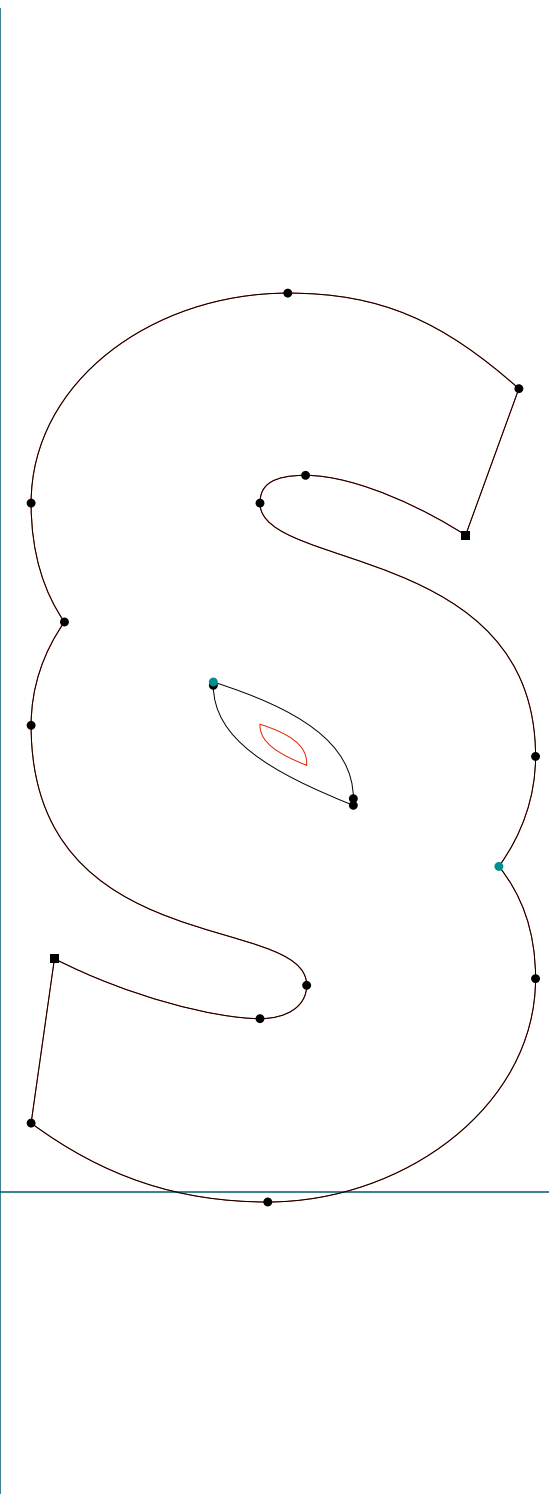

**BASE 9 & 12**

BaseTwelve SansSCB | AE | RoboFog Sketches | 1995 | Emigre Fonts

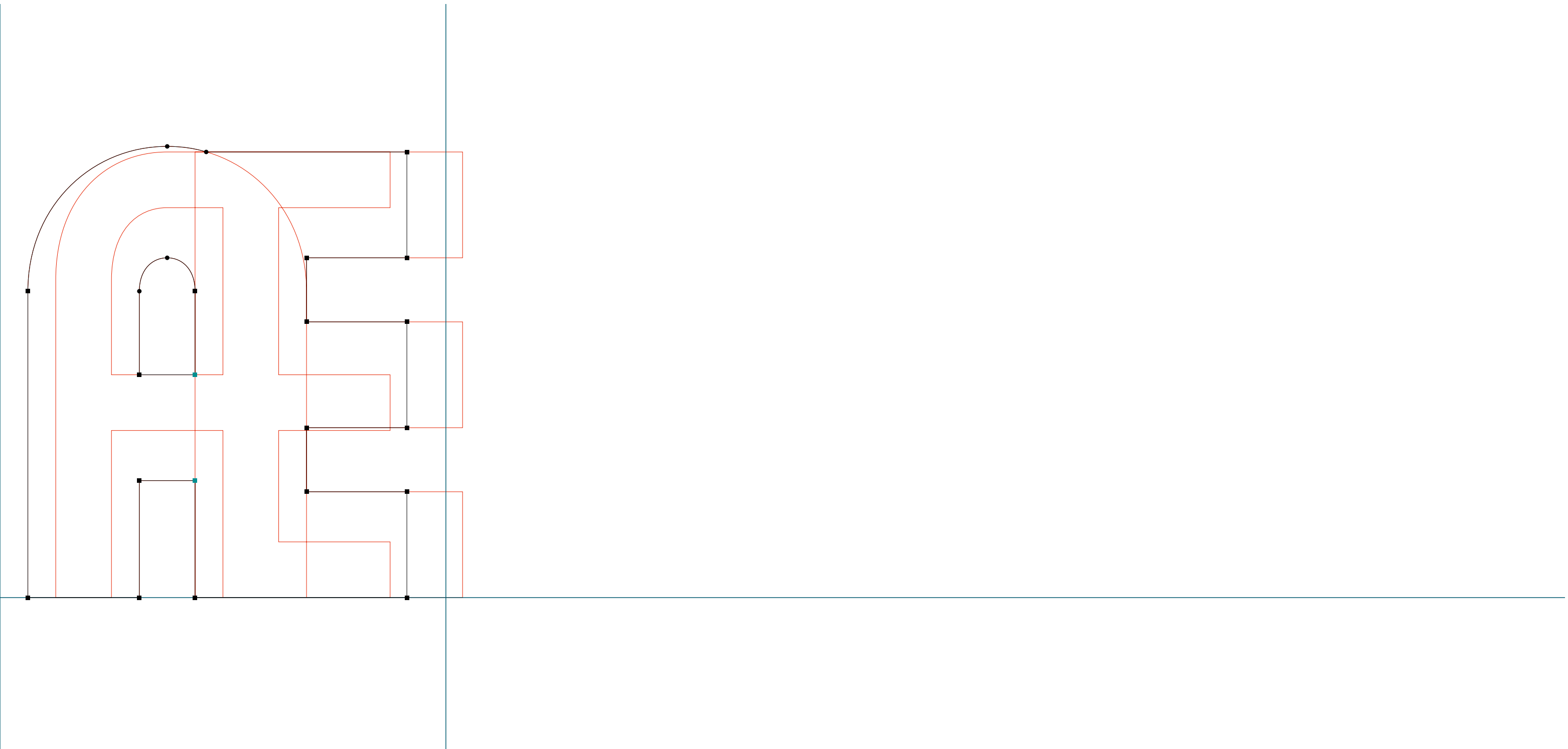

**BASE 9 & 12**

.....  
BaseTwelve SansSCB | Omega | RoboFog Sketches | 1995 | Emigre Fonts

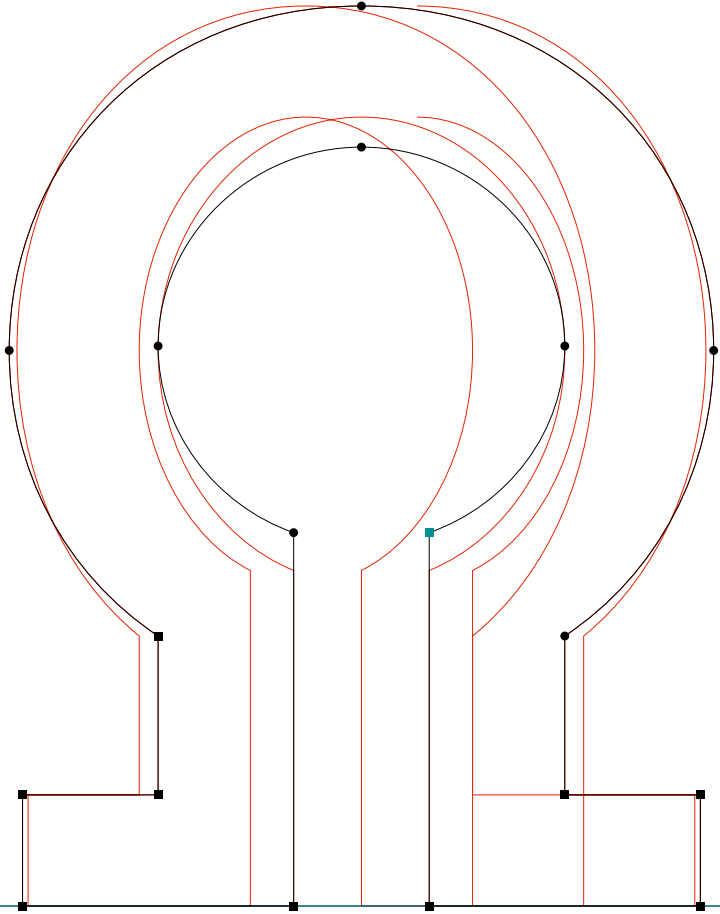

**BASE 9 & 12**

BaseTwelve SansSCB | daggerdbl | RoboFog Sketches | 1995 | Emigre Fonts

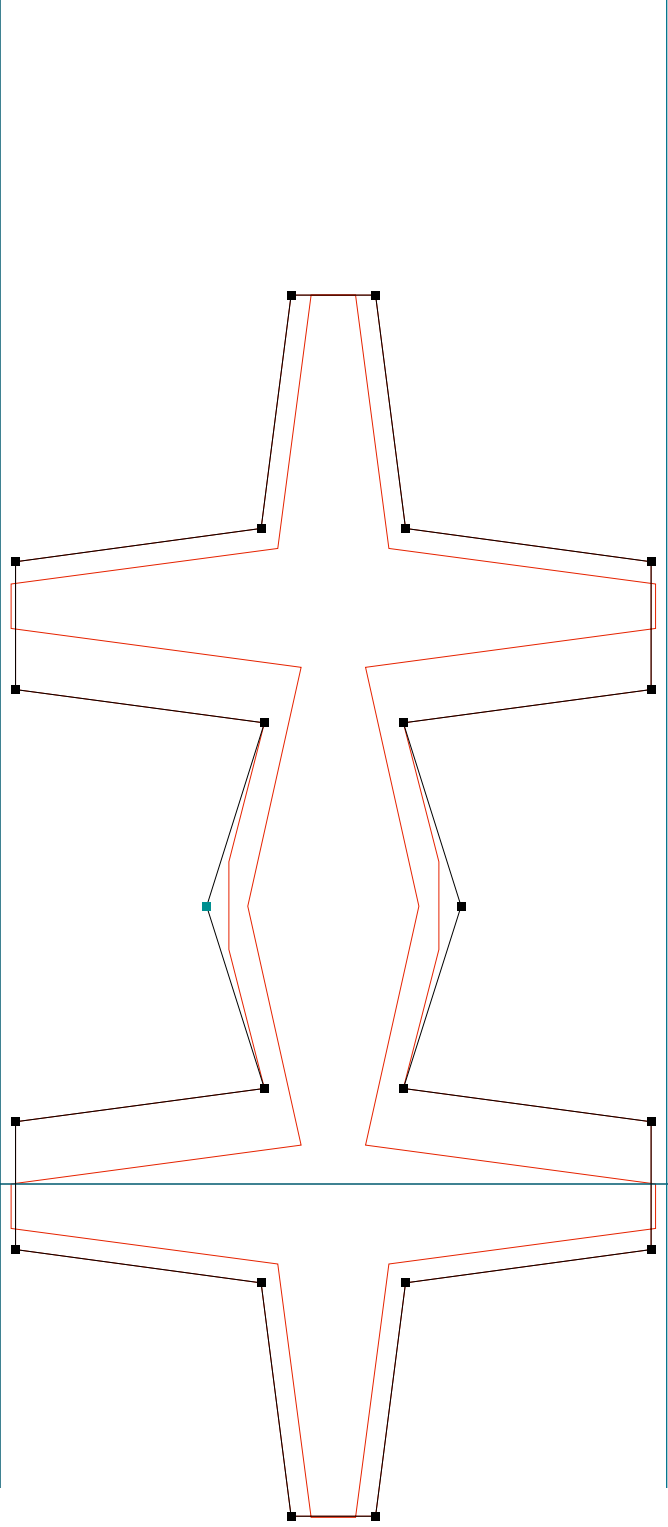

**BASE 9 & 12**

.....  
BaseTwelve SansBI | quotedbl | RoboFog Sketches | 1995 | Emigre Fonts

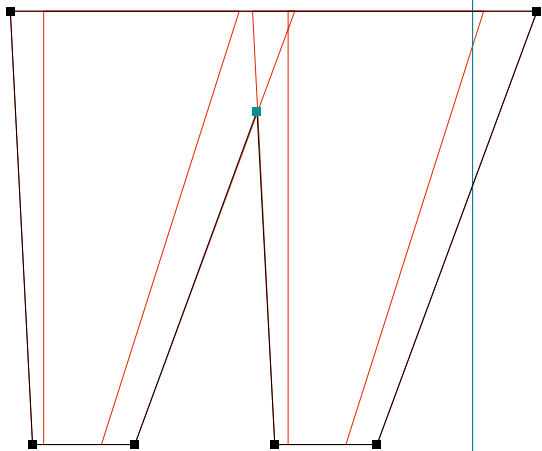

**BASE 9 & 12**

.....  
BaseTwelve SansBI | six | RoboFog Sketches | 1995 | Emigre Fonts

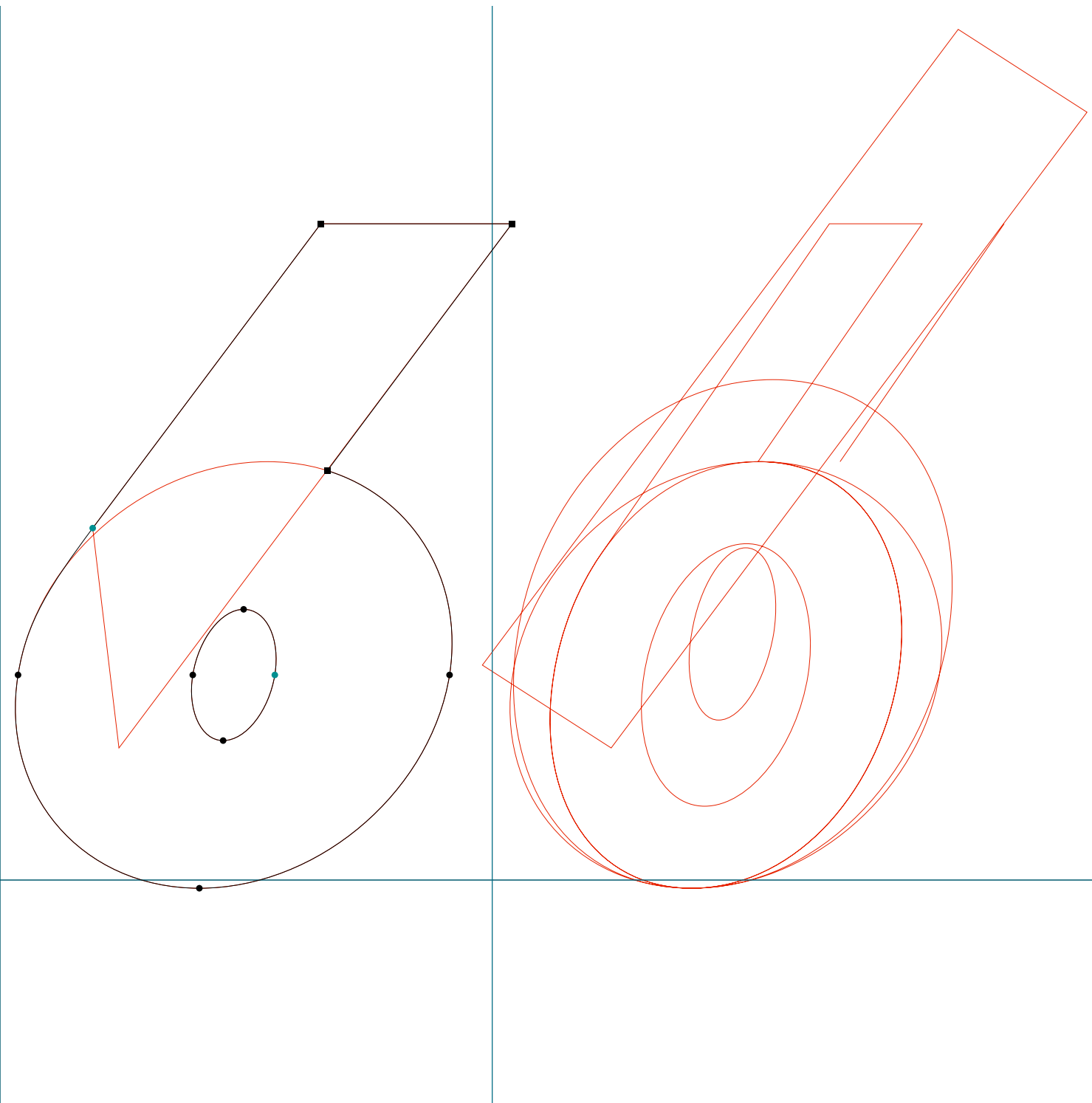

**BASE 9 & 12**

.....  
BaseTwelve SansBI | eight | RoboFog Sketches | 1995 | Emigre Fonts

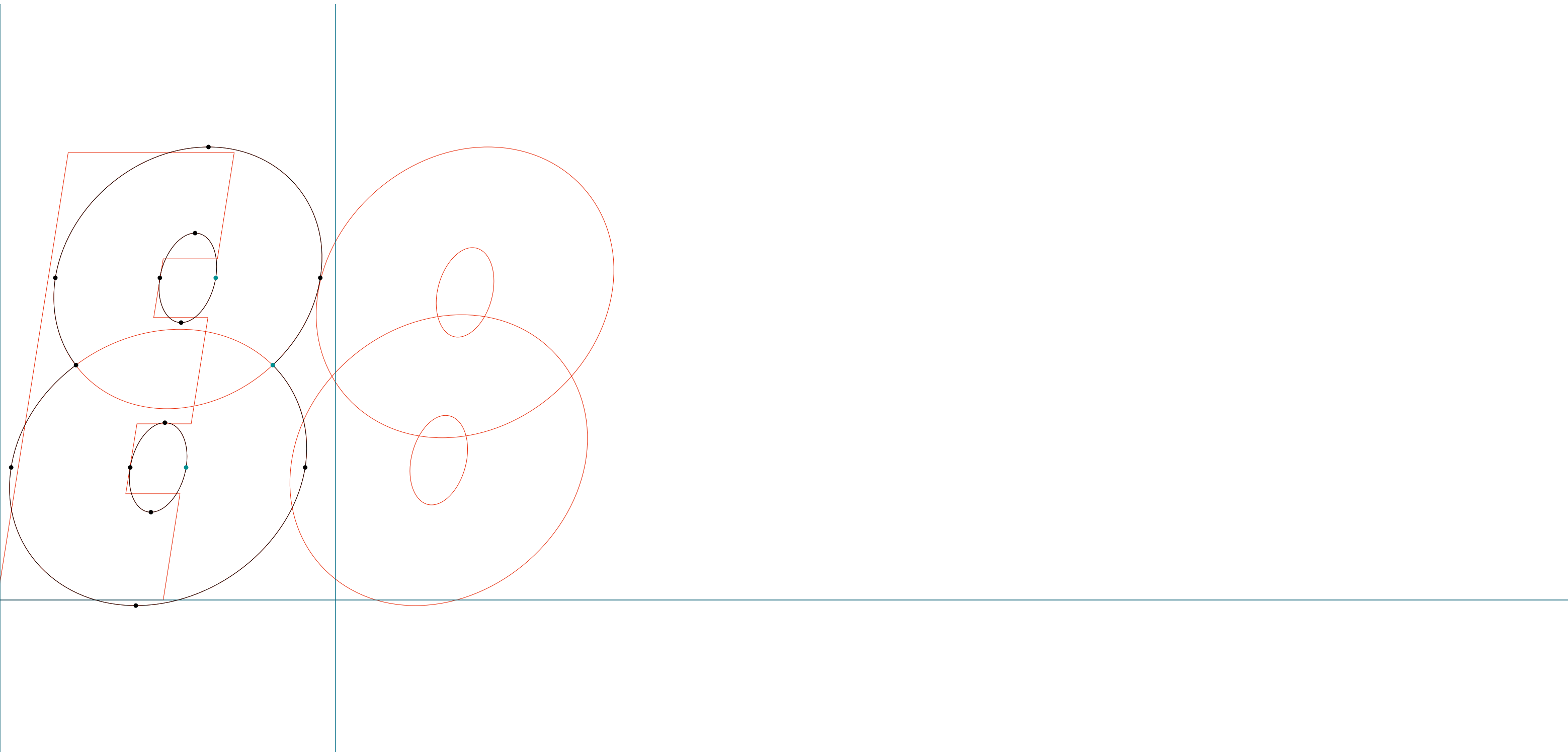

**BASE 9 & 12**

.....  
BaseTwelve SansBI | A | RoboFog Sketches | 1995 | Emigre Fonts

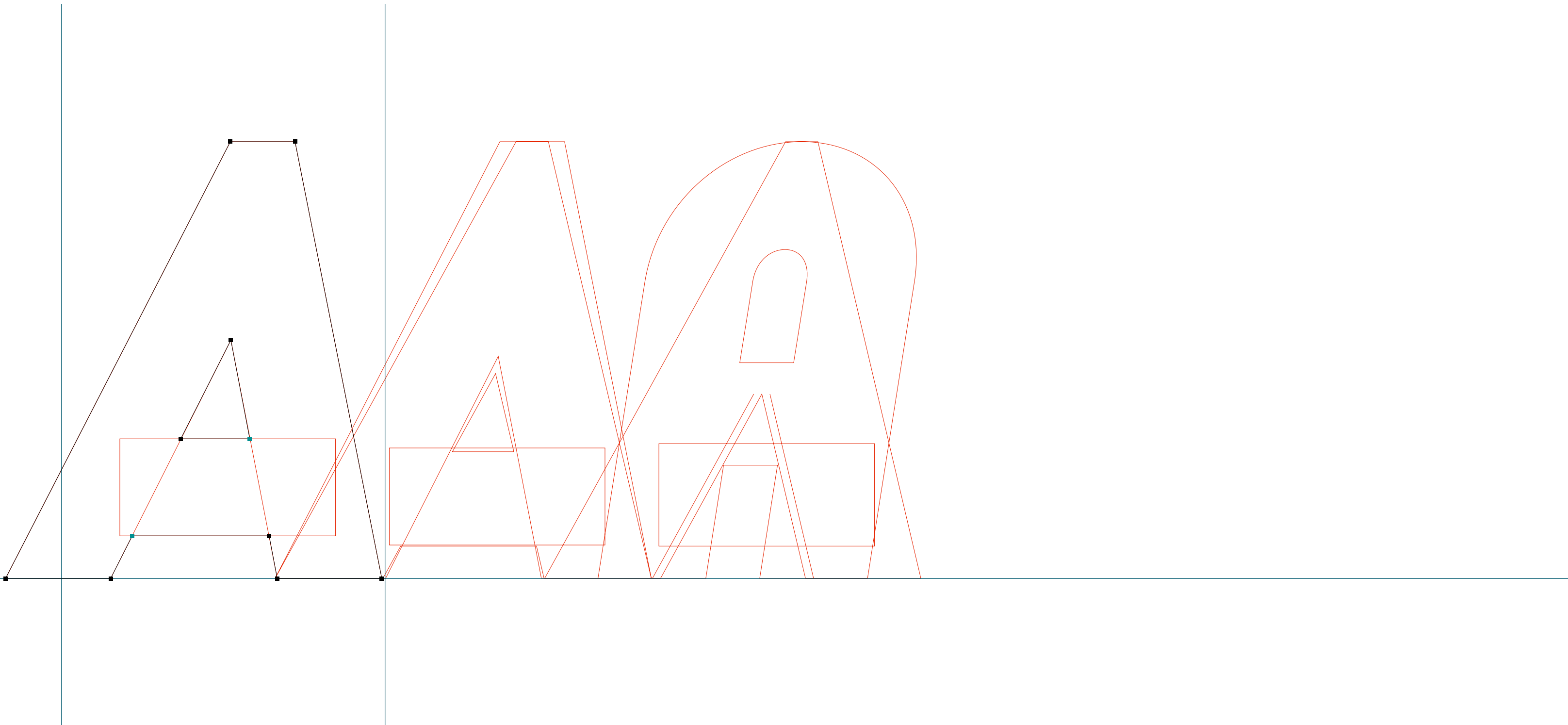



**BASE 9 & 12**

.....  
BaseTwelve SansBI | B | RoboFog Sketches | 1995 | Emigre Fonts

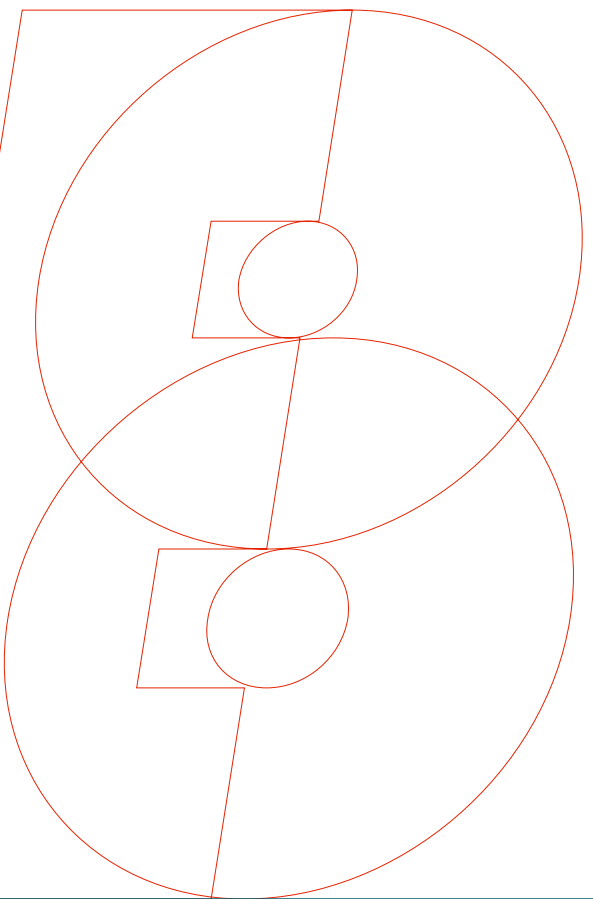
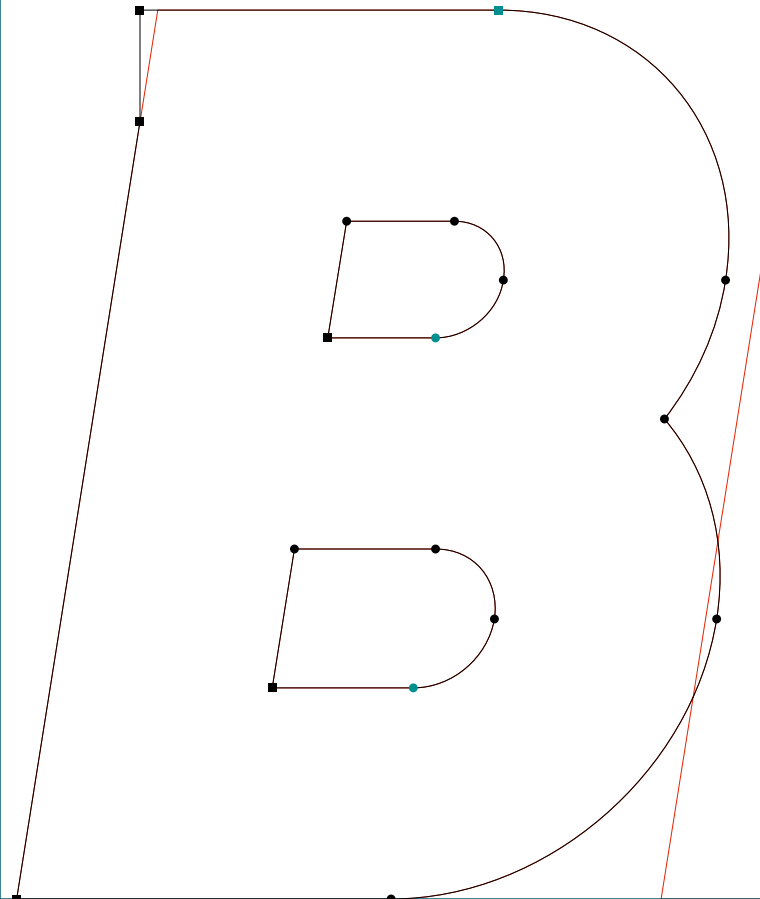
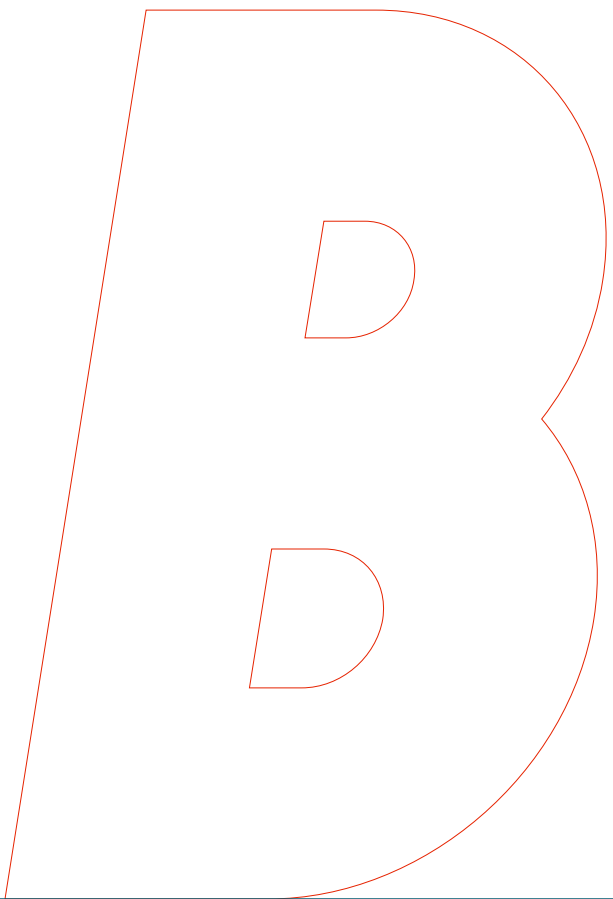

**BASE 9 & 12**

.....  
BaseTwelve SansBI | e | RoboFog Sketches | 1995 | Emigre Fonts

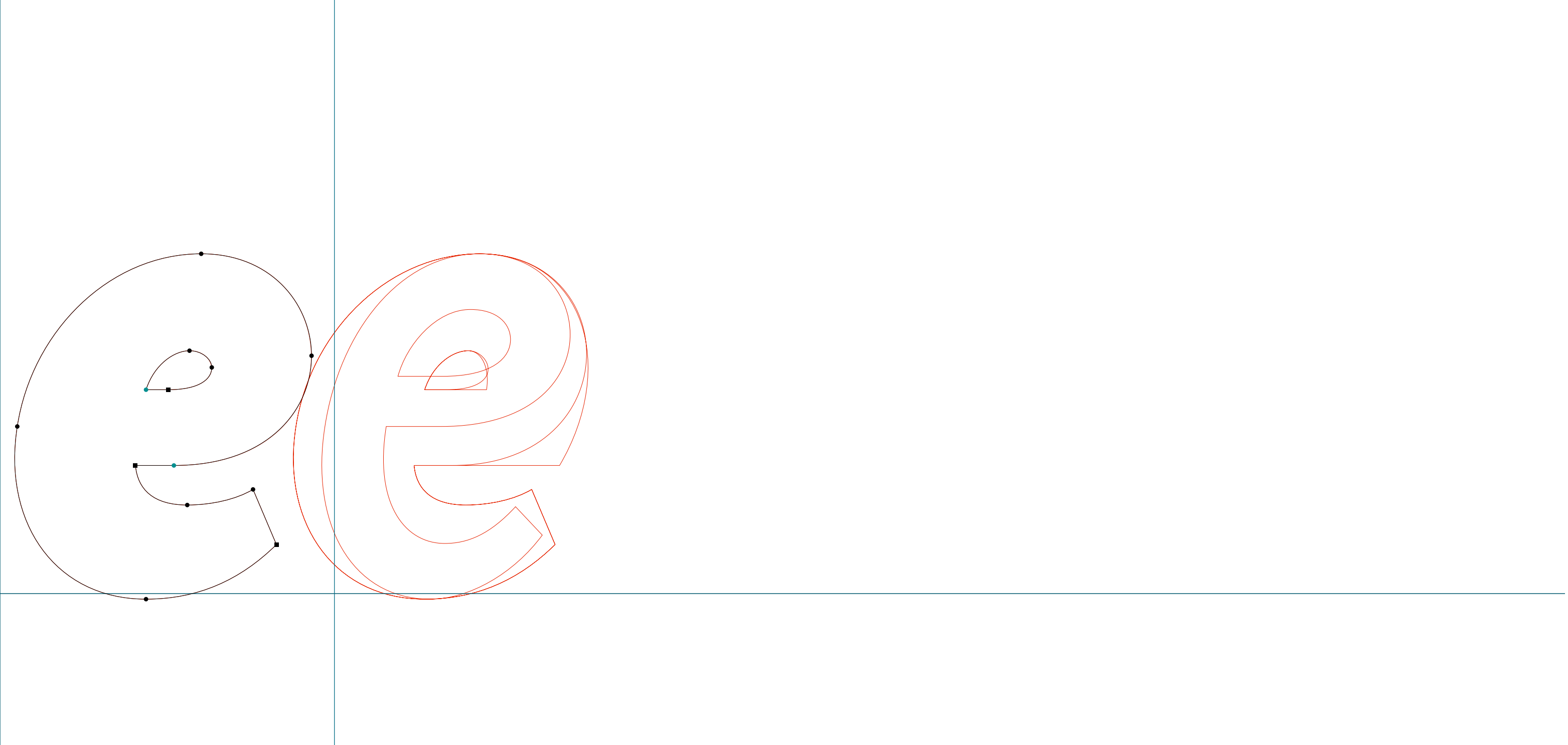

**BASE 9 & 12**

.....  
BaseTwelve SansBI | section | RoboFog Sketches | 1995 | Emigre Fonts

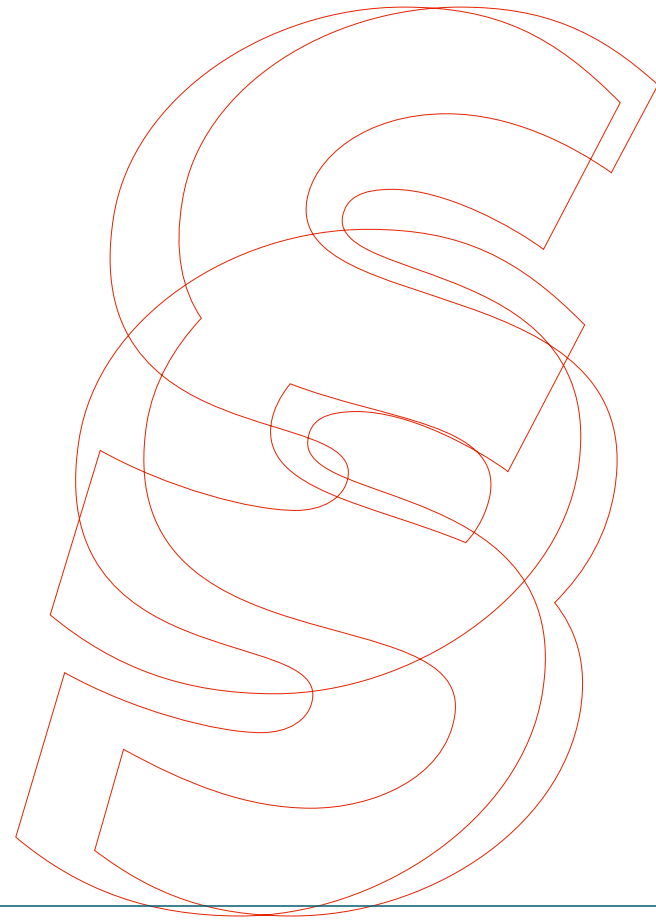
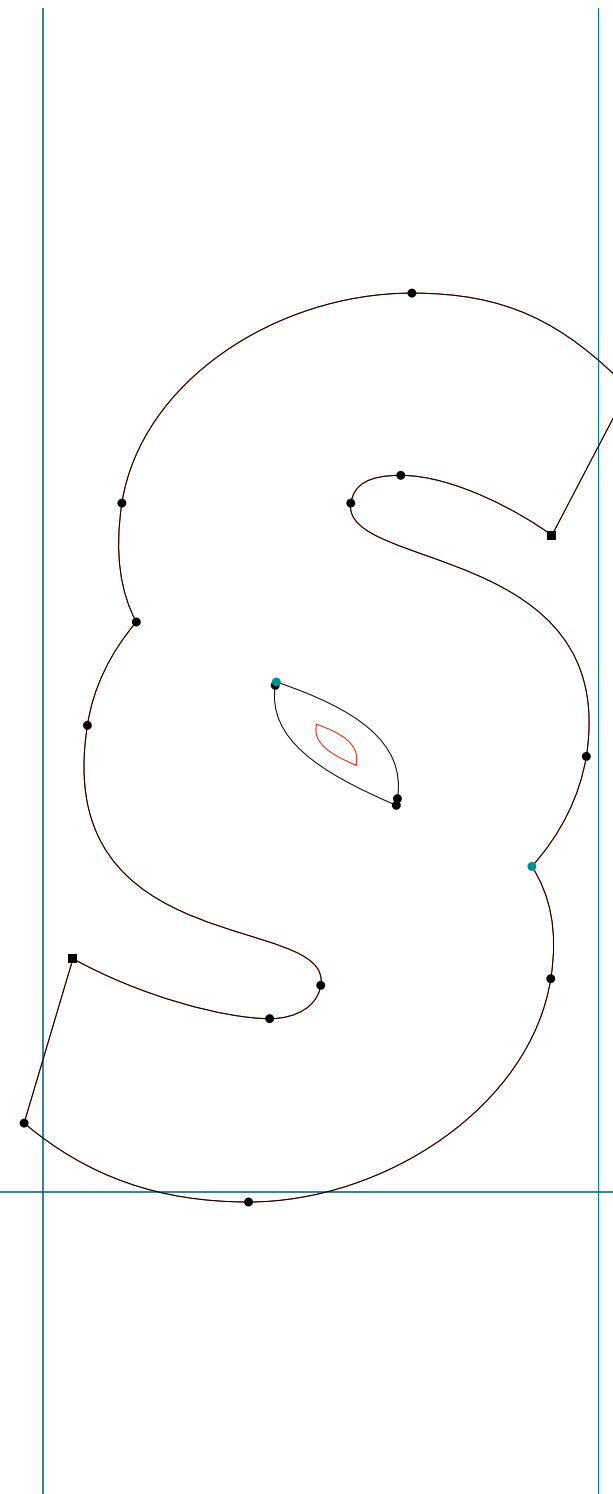

**BASE 9 & 12**

.....  
BaseTwelve SansBI | AE | RoboFog Sketches | 1995 | Emigre Fonts

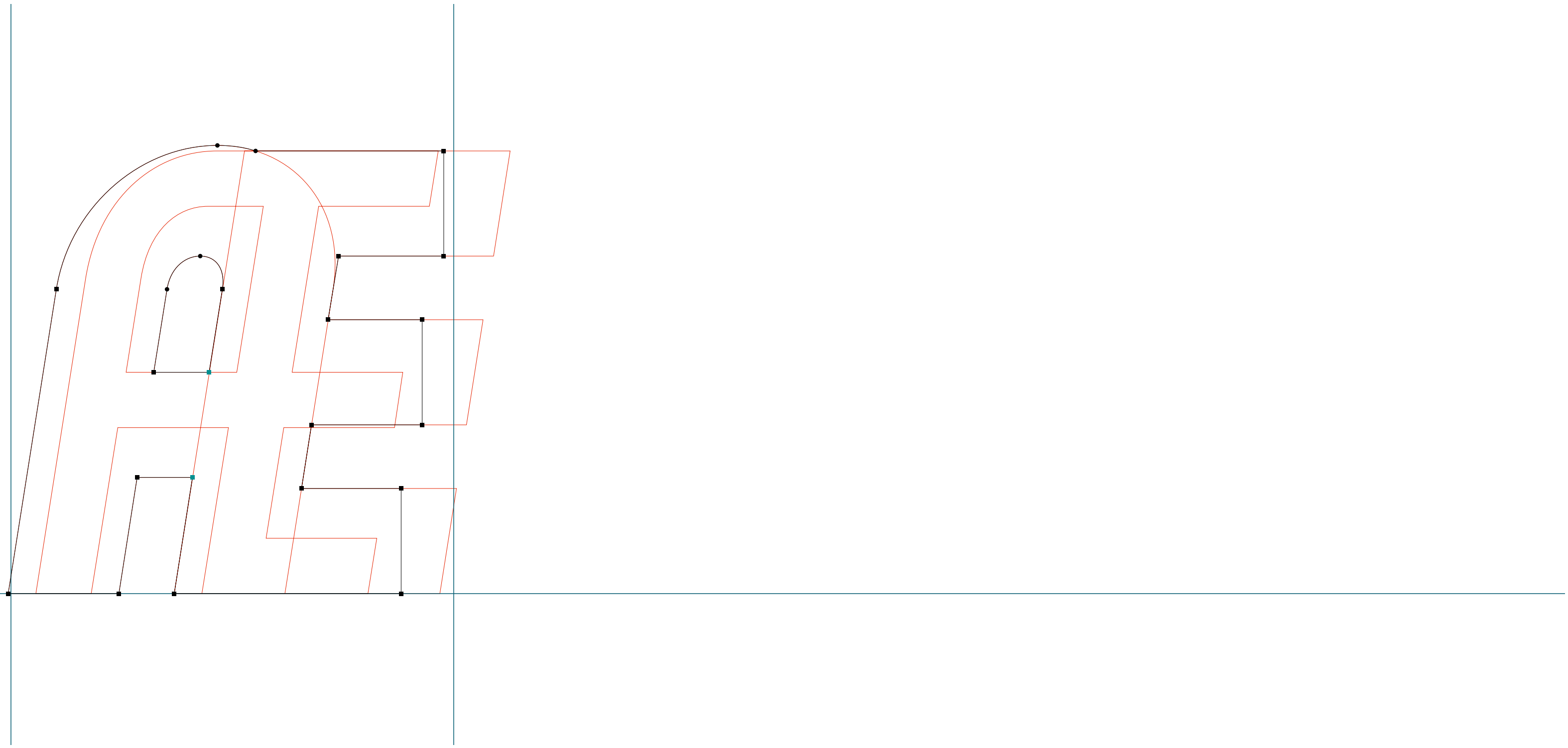

**BASE 9 & 12**

.....  
BaseTwelve SansBI | Omega | RoboFog Sketches | 1995 | Emigre Fonts

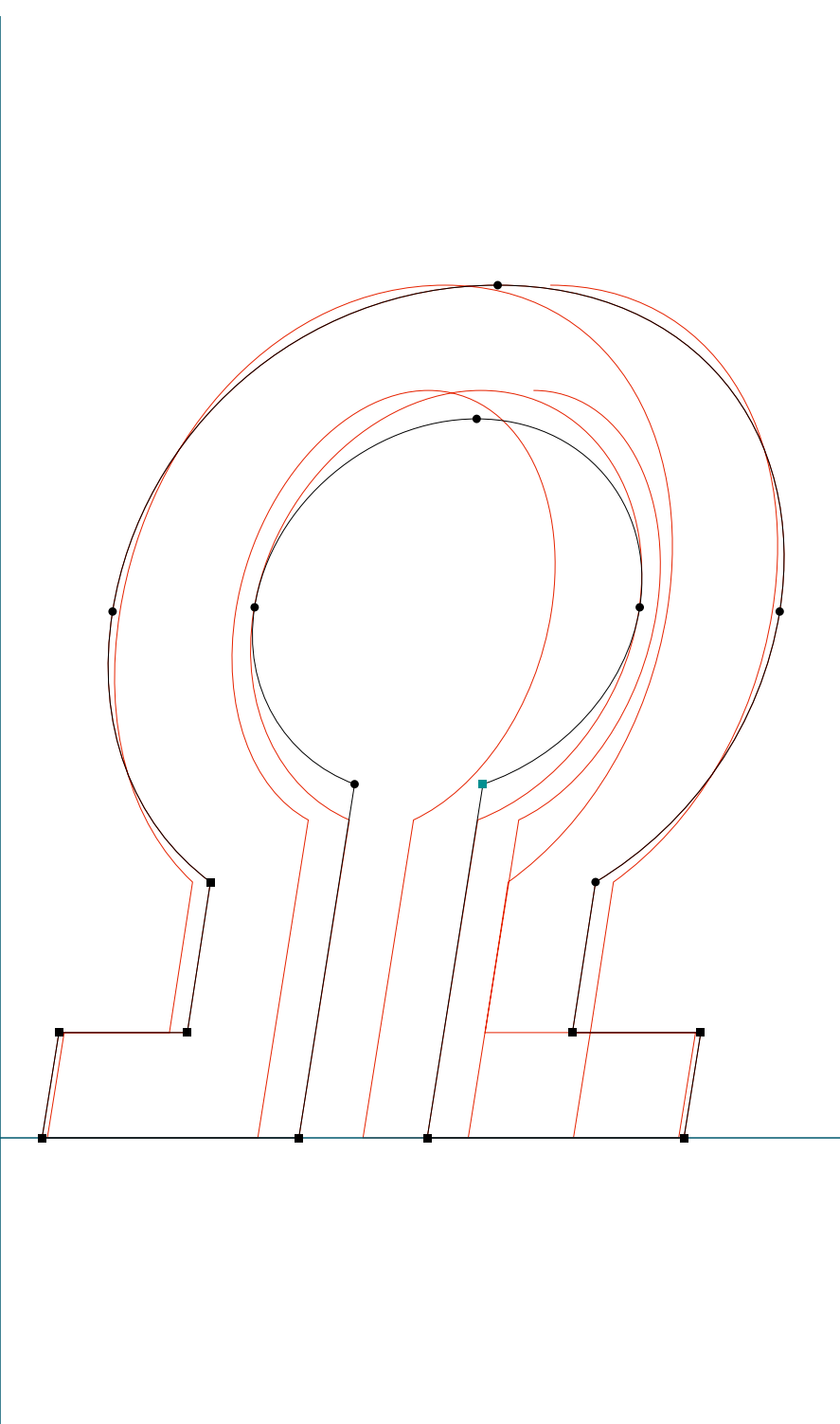

**BASE 9 & 12**

.....  
BaseTwelve SansBI | daggerdbl | RoboFog Sketches | 1995 | Emigre Fonts

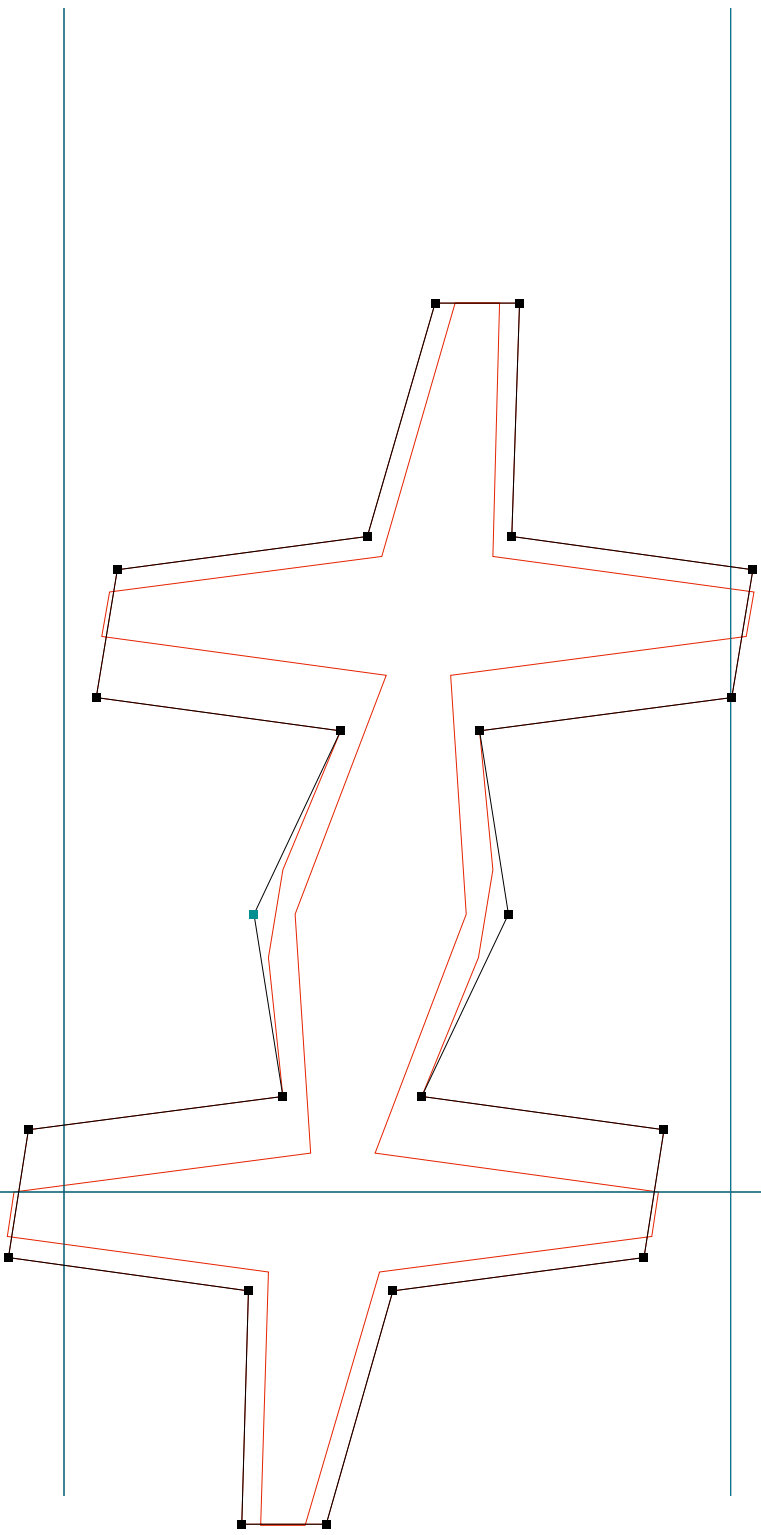

**BASE 9 & 12**

.....  
BaseTwelve SansSCBI | quotedbl | RoboFog Sketches | 1995 | Emigre Fonts

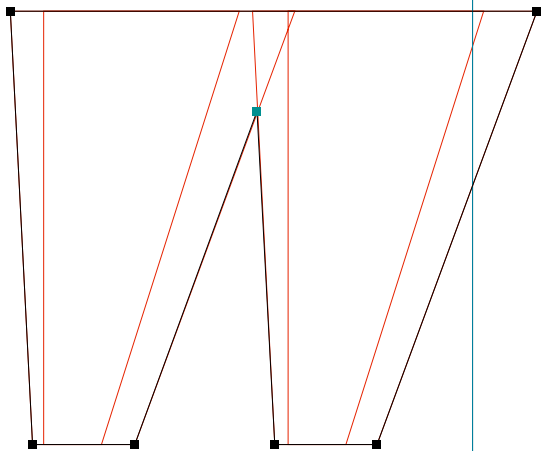

**BASE 9 & 12**

.....  
BaseTwelve SansSCBI | B | RoboFog Sketches | 1995 | Emigre Fonts

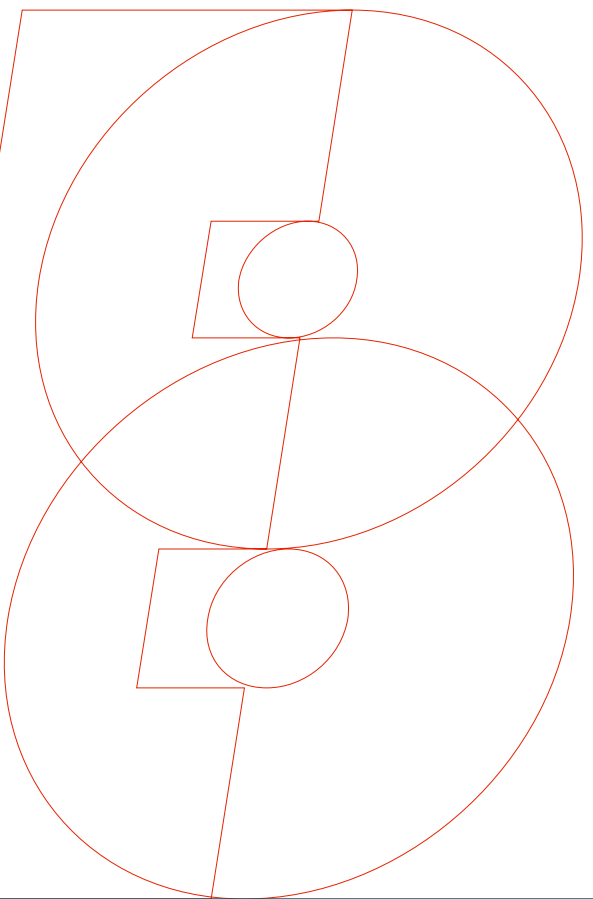
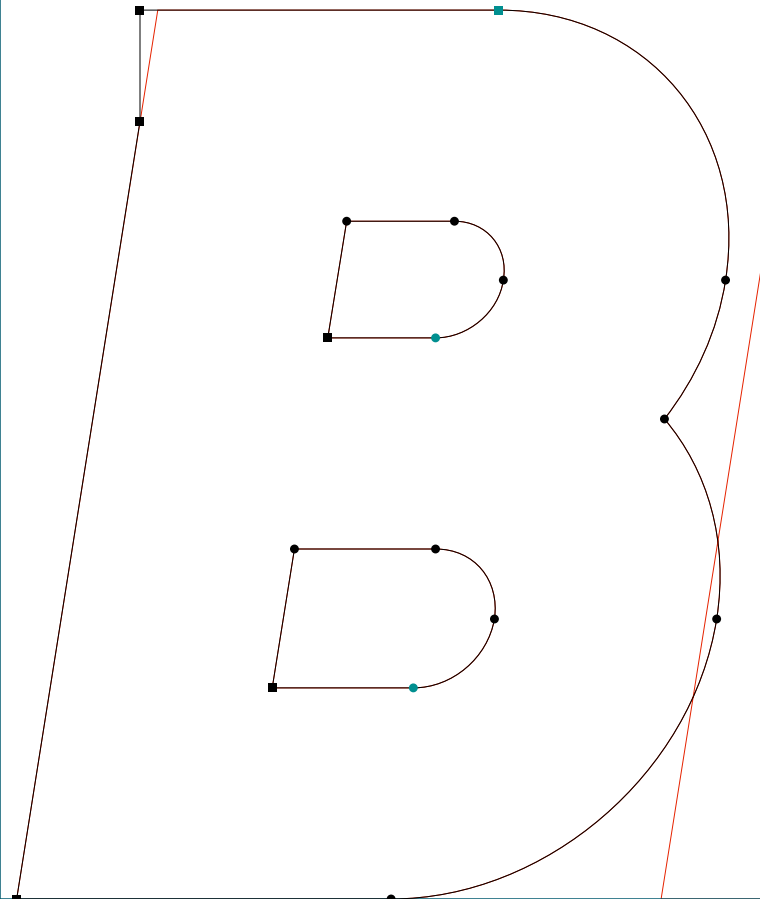
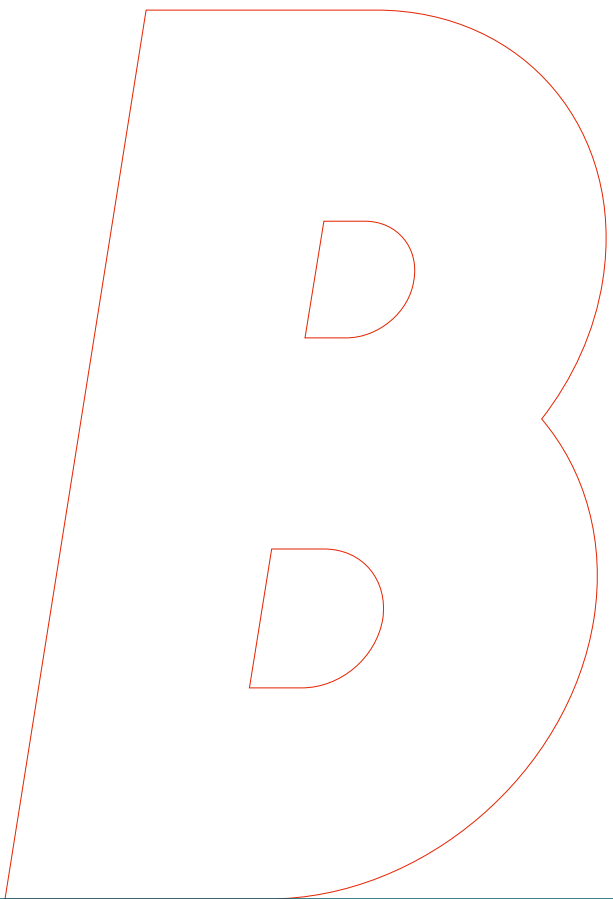



**BASE 9 & 12**

.....  
BaseTwelve SansSCBI | a | RoboFog Sketches | 1995 | Emigre Fonts

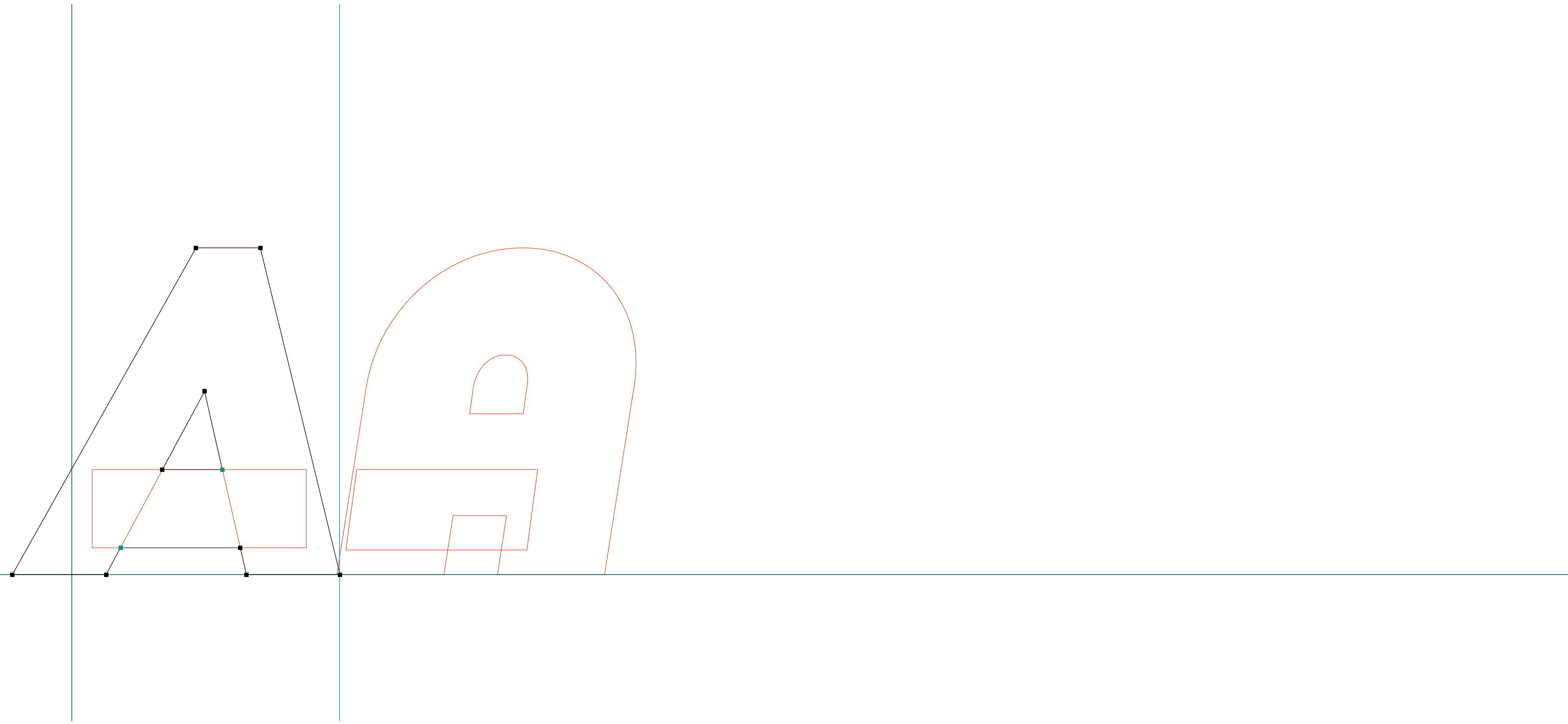

**BASE 9 & 12**

.....  
BaseTwelve SansSCBI | section | RoboFog Sketches | 1995 | Emigre Fonts

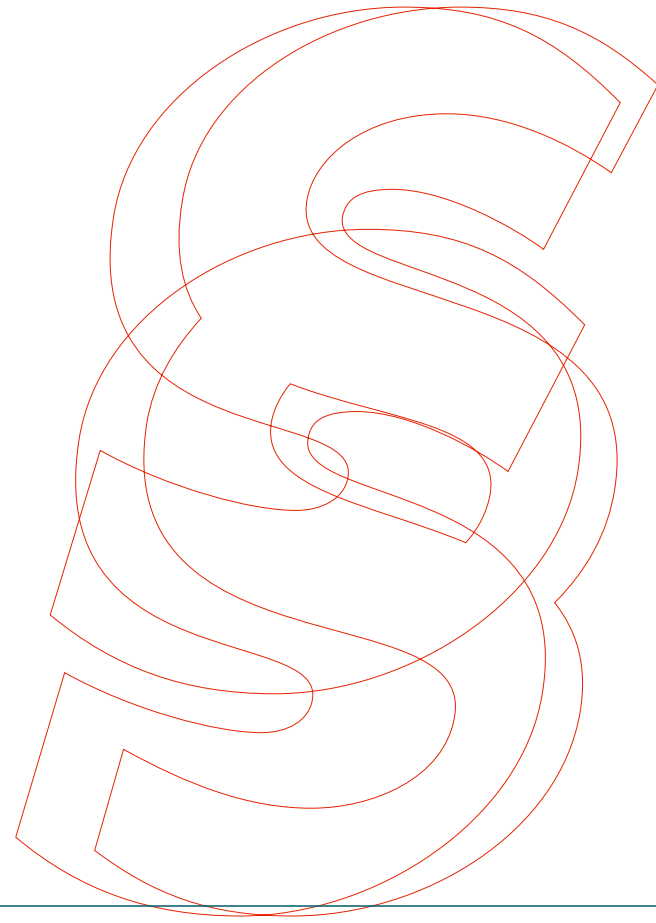
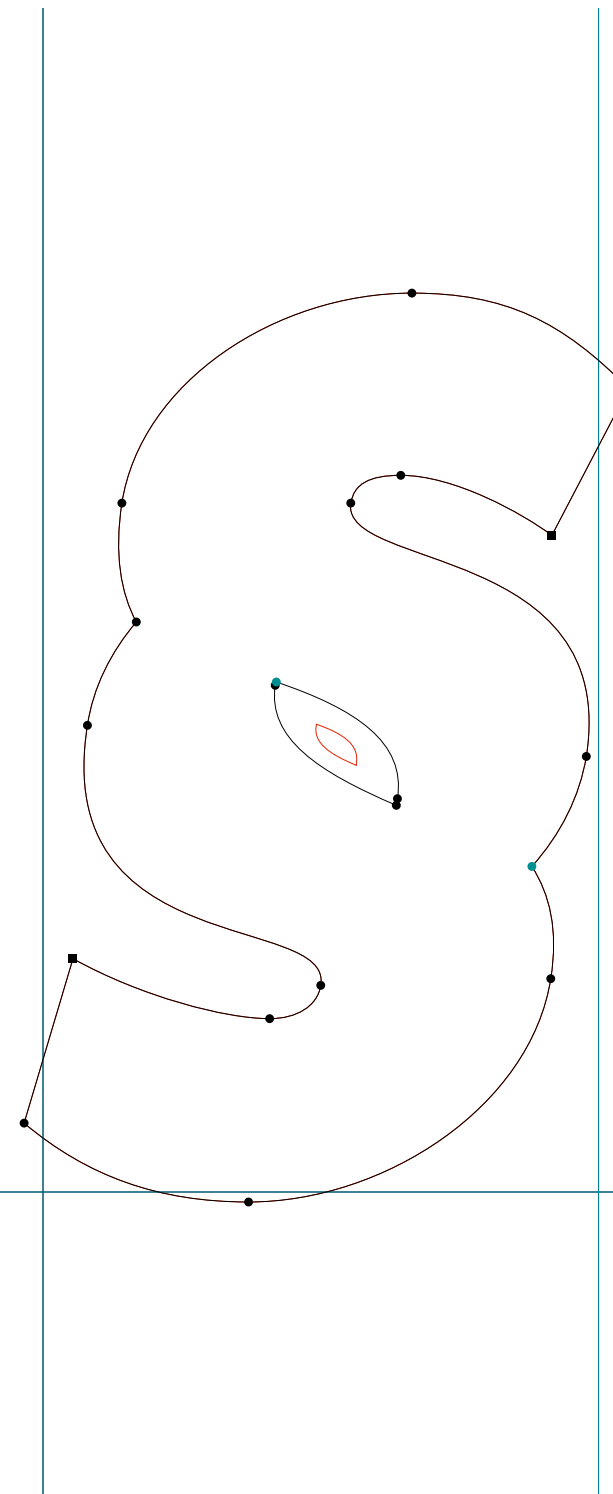

**BASE 9 & 12**

.....  
BaseTwelve SansSCBI | AE | RoboFog Sketches | 1995 | Emigre Fonts

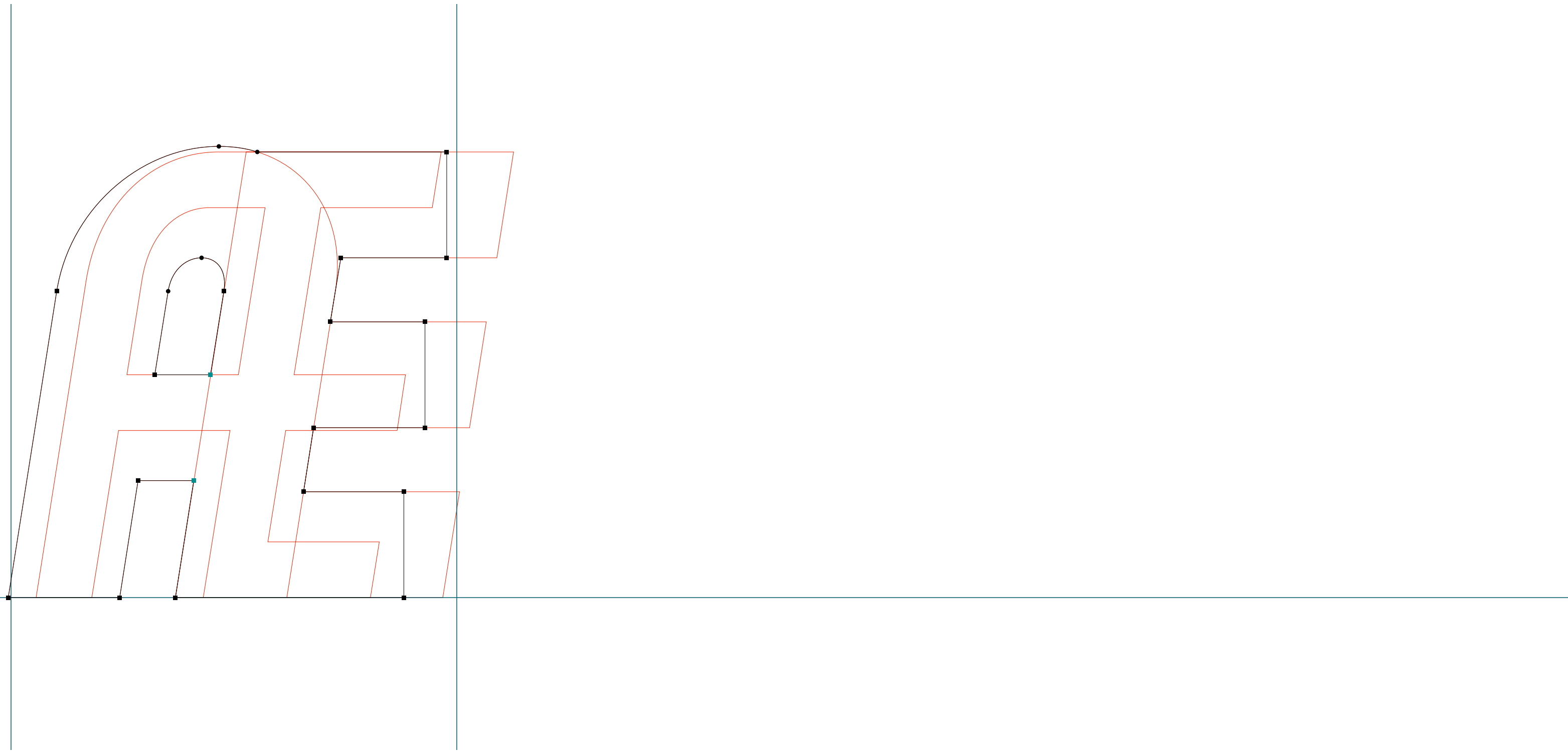

**BASE 9 & 12**

.....  
BaseTwelve SansSCBI | Omega | RoboFog Sketches | 1995 | Emigre Fonts

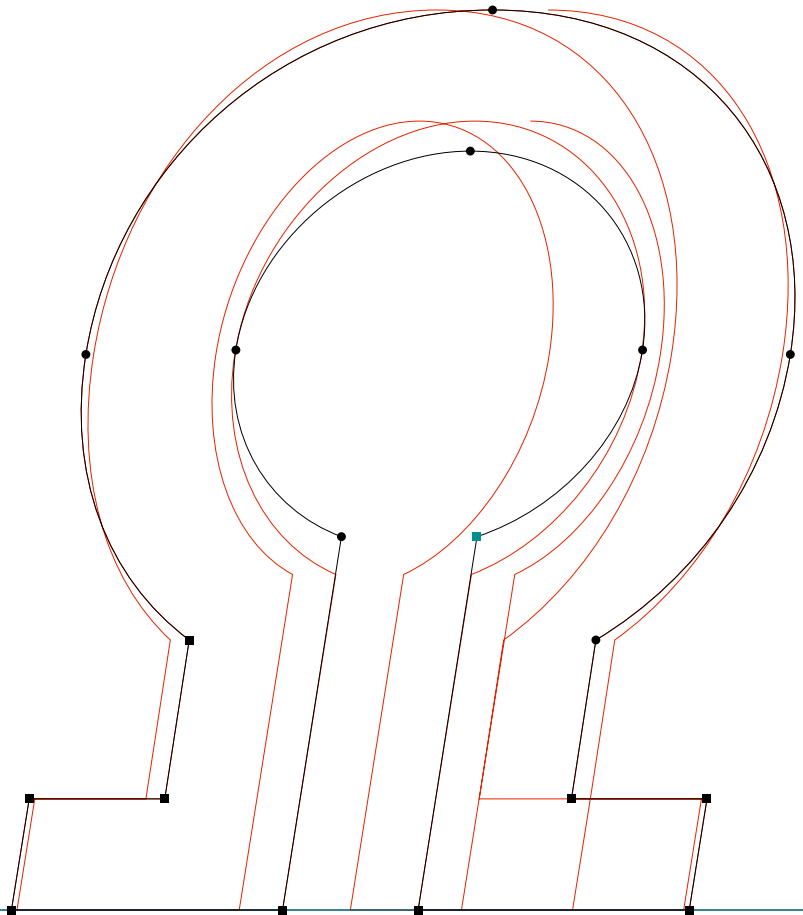

**BASE 9 & 12**

.....  
BaseTwelve SansSCBI | daggerdbl | RoboFog Sketches | 1995 | Emigre Fonts

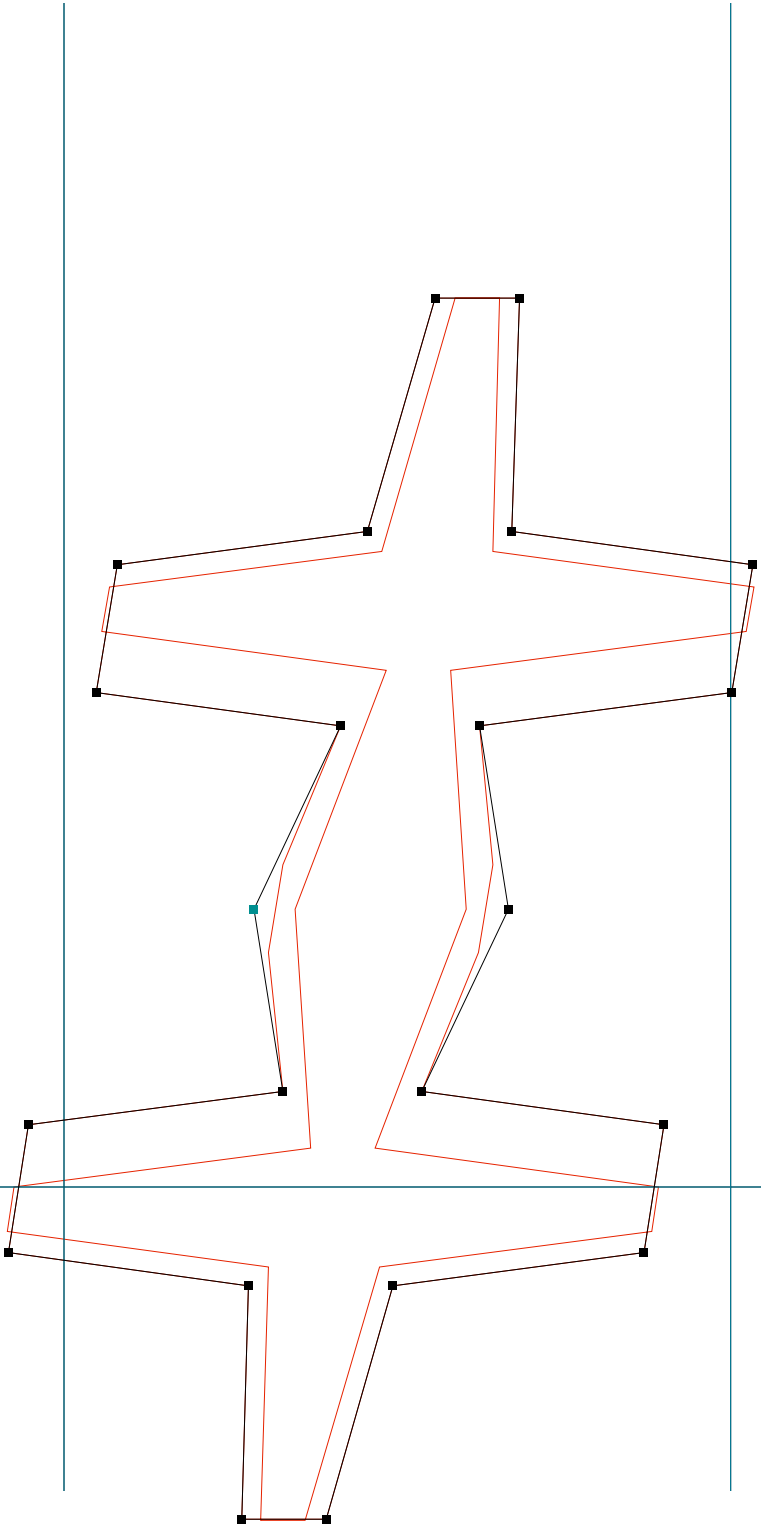

**BASE 9 & 12**

.....  
BaseTwelve Serif | ampersand | RoboFog Sketches | 1995 | Emigre Fonts

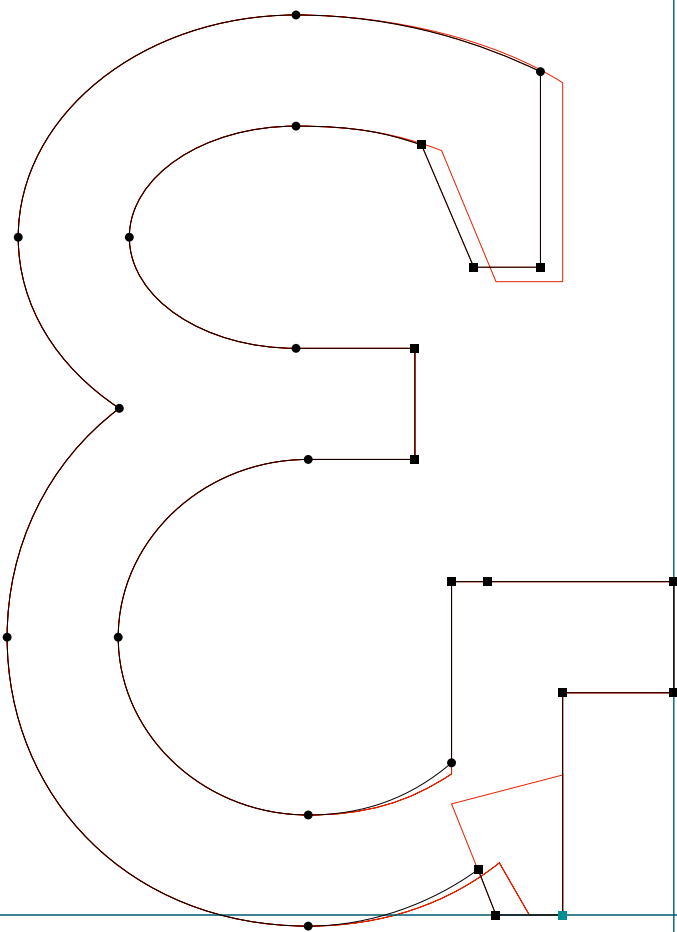

**BASE 9 & 12**

.....  
BaseTwelve Serif | two | RoboFog Sketches | 1995 | Emigre Fonts

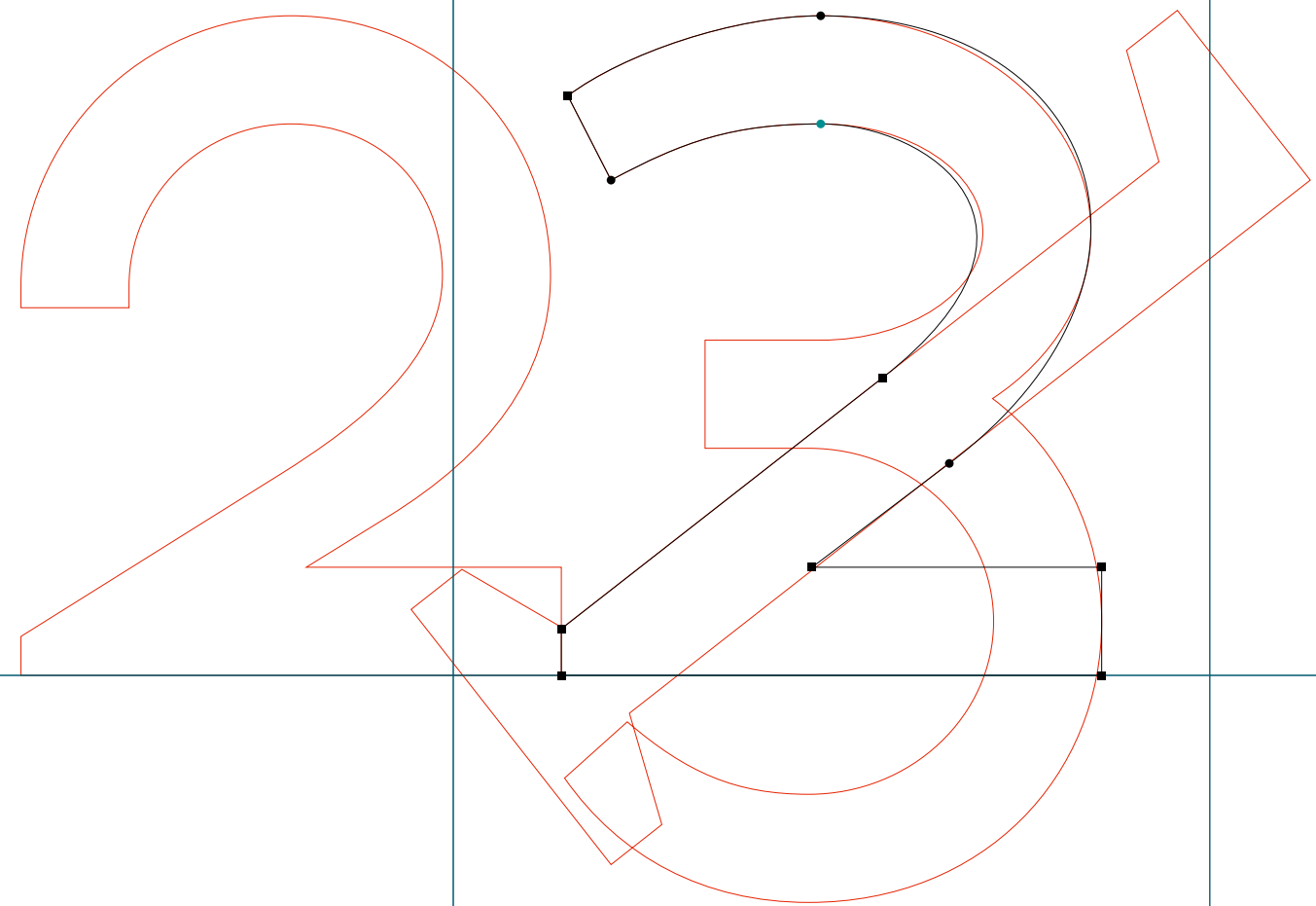

**BASE 9 & 12**

.....  
BaseTwelve Serif | three | RoboFog Sketches | 1995 | Emigre Fonts

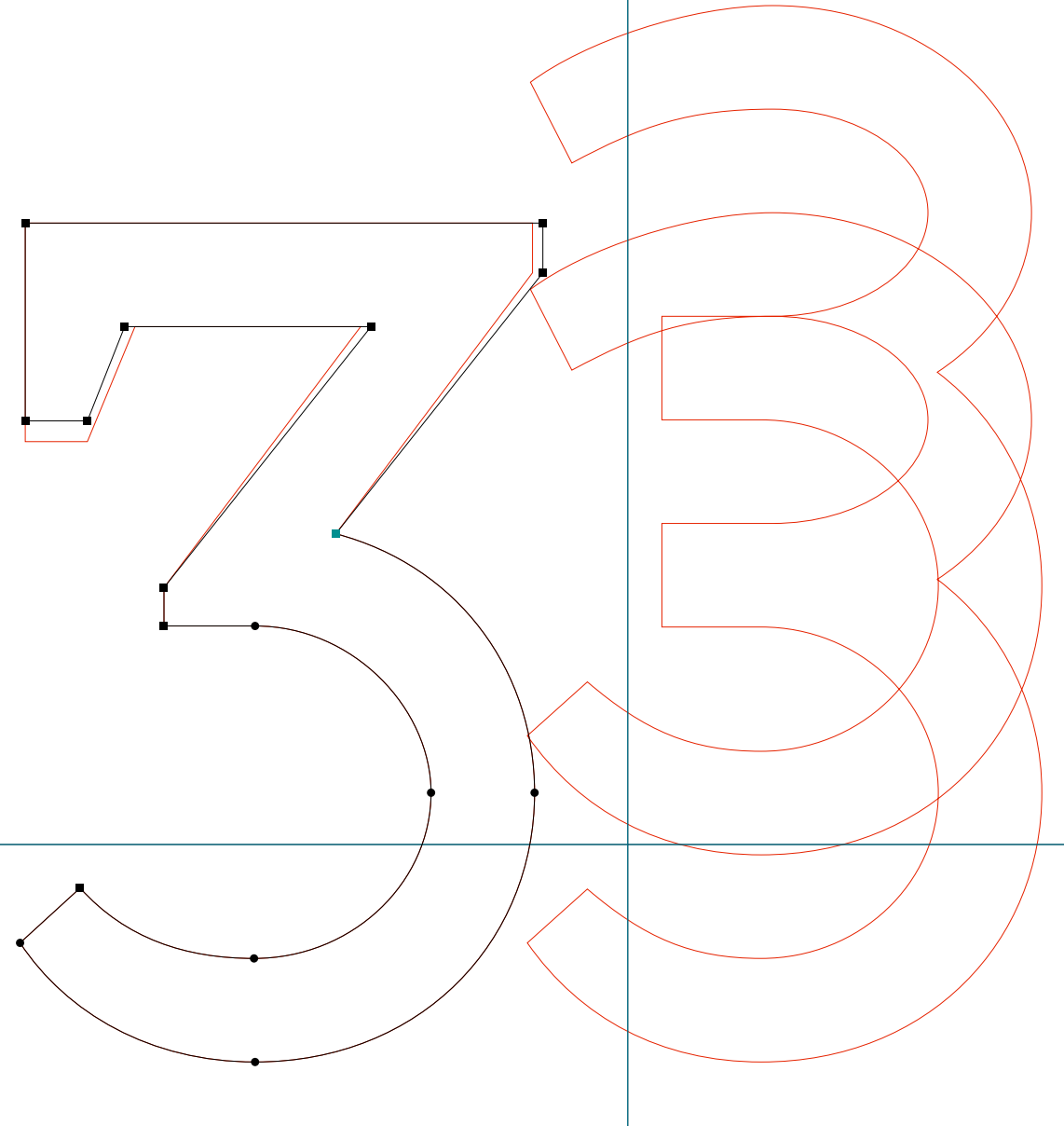



**BASE 9 & 12**

.....  
BaseTwelve Serif | question | RoboFog Sketches | 1995 | Emigre Fonts

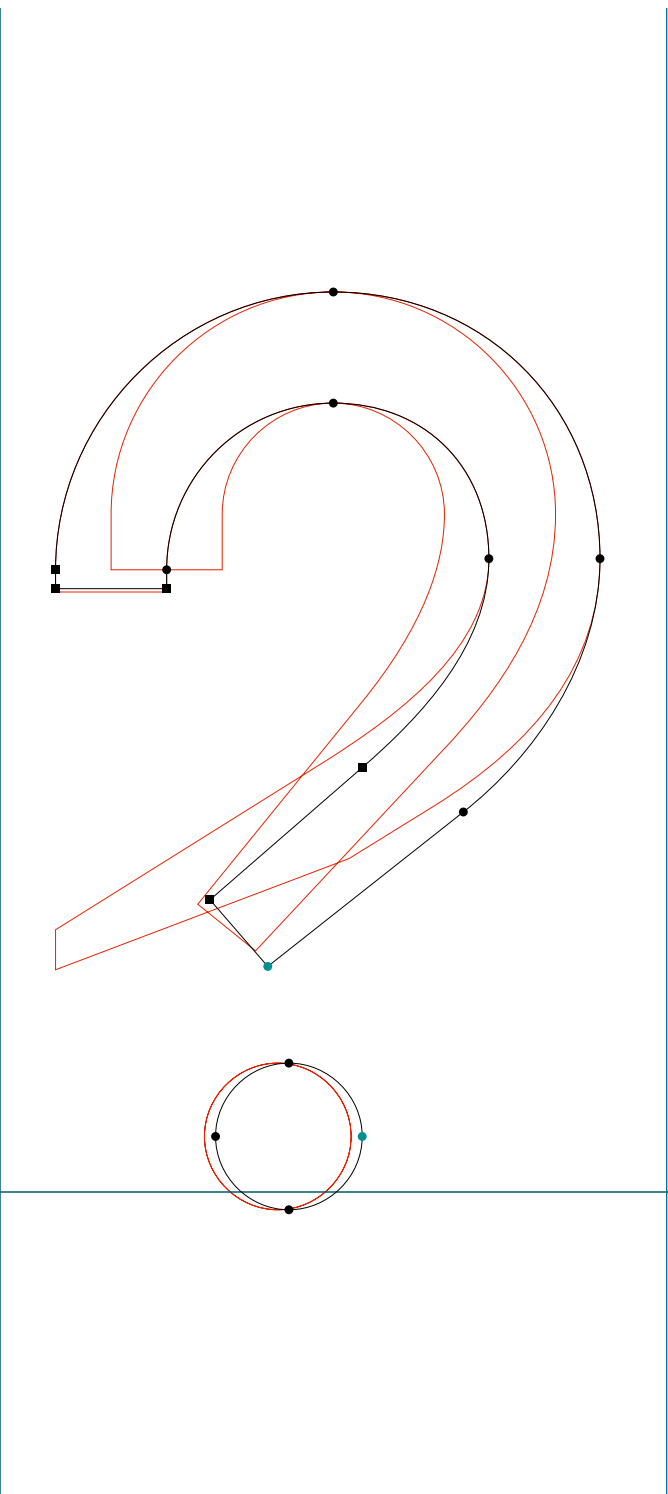

**BASE 9 & 12**

.....  
BaseTwelve Serif | G | RoboFog Sketches | 1995 | Emigre Fonts

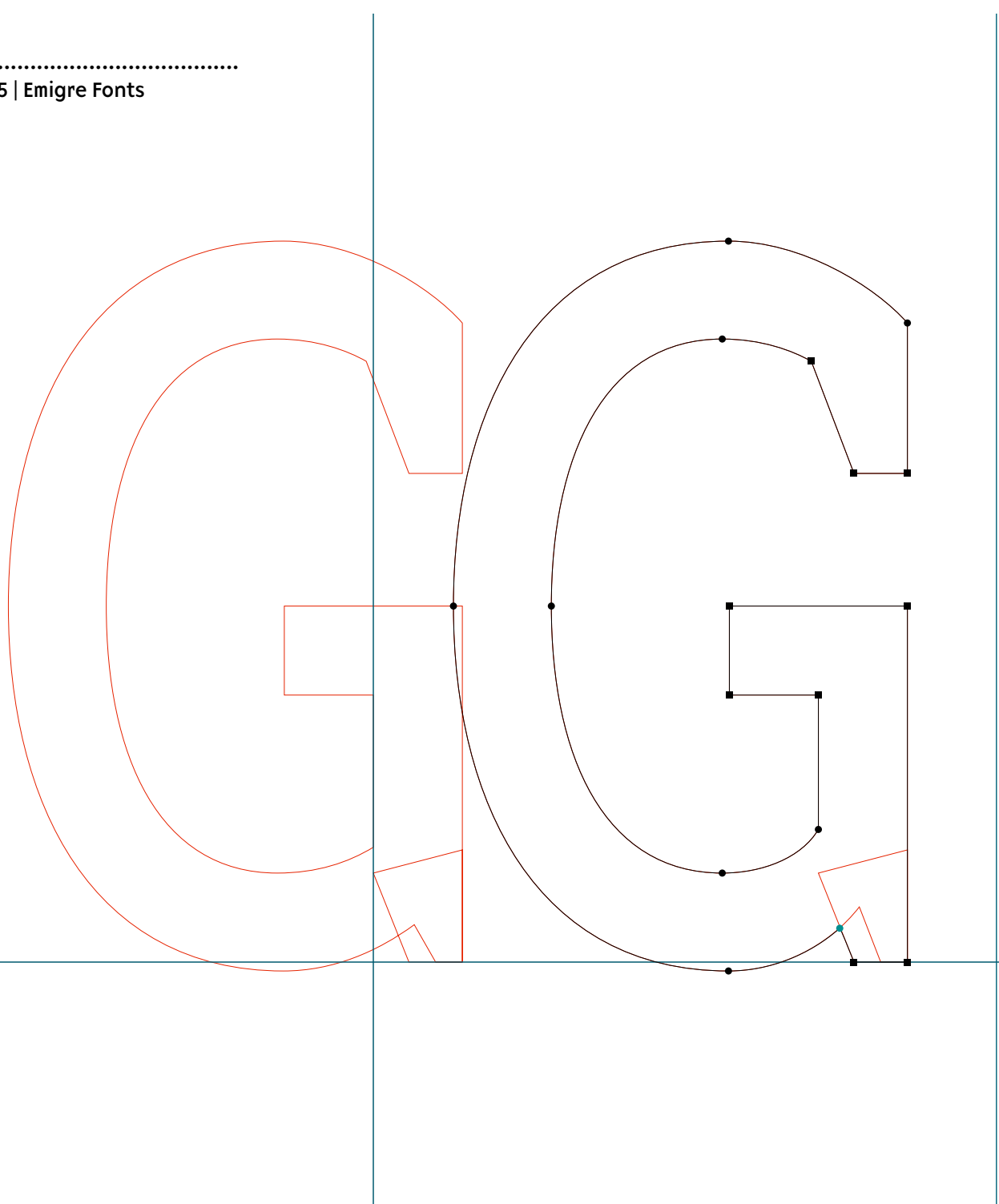

**BASE 9 & 12**

.....  
BaseTwelve Serif | a | RoboFog Sketches | 1995 | Emigre Fonts

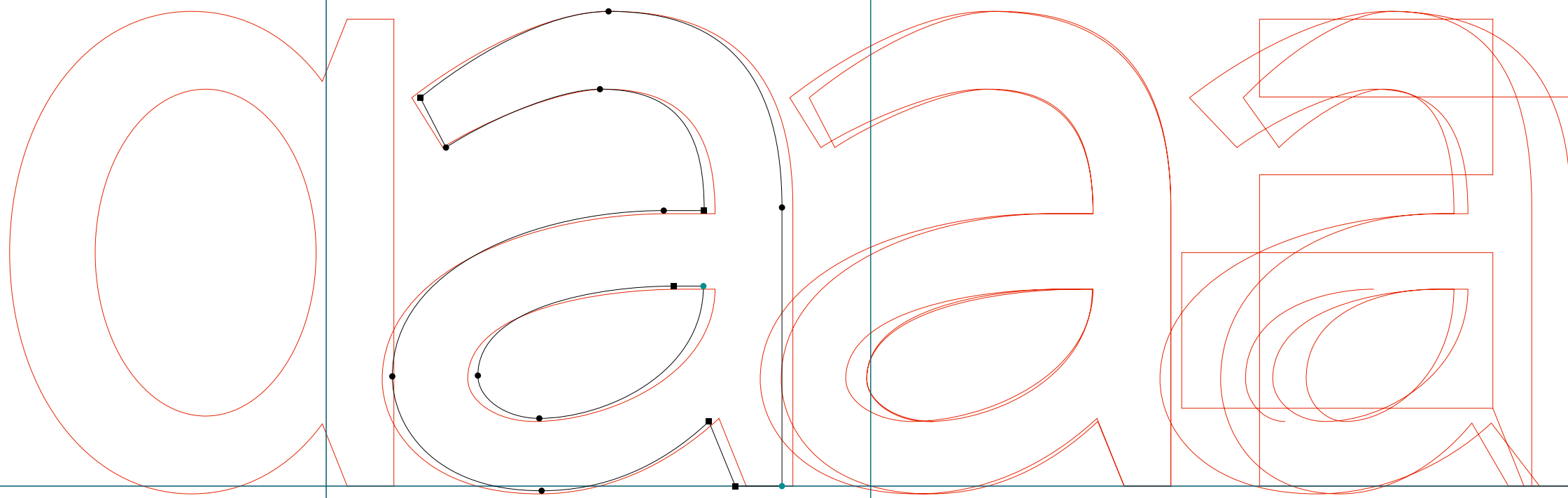

**BASE 9 & 12**

BaseTwelve Serif | g | RoboFog Sketches | 1995 | Emigre Fonts

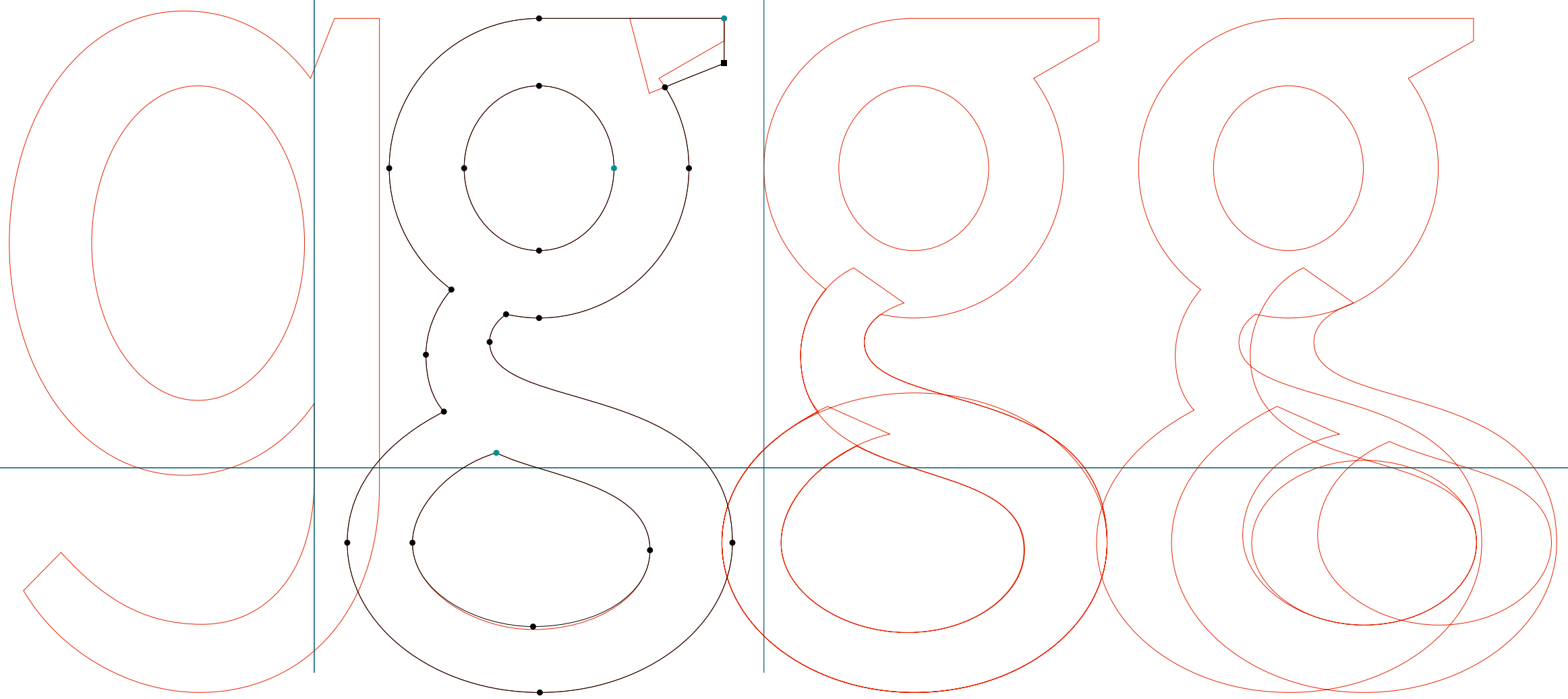

**BASE 9 & 12**

.....  
BaseTwelve SerifSmallcaps | two | RoboFog Sketches | 1995 | Emigre Fonts

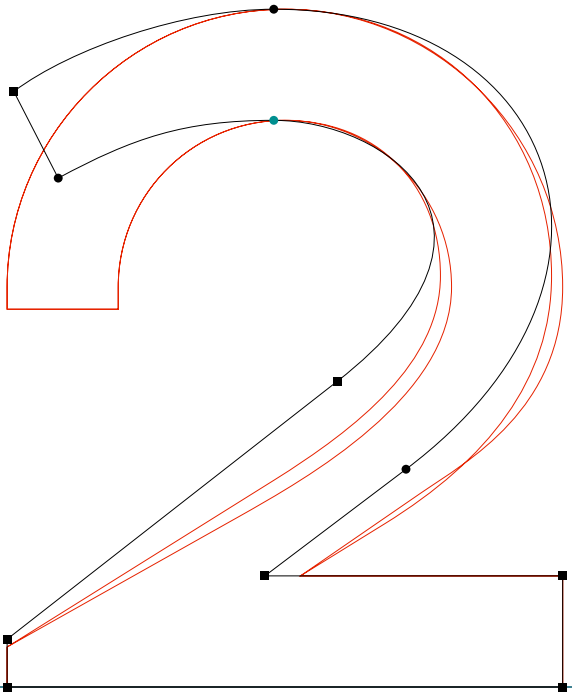

**BASE 9 & 12**

.....  
BaseTwelve SerifSmallcaps | three | RoboFog Sketches | 1995 | Emigre Fonts

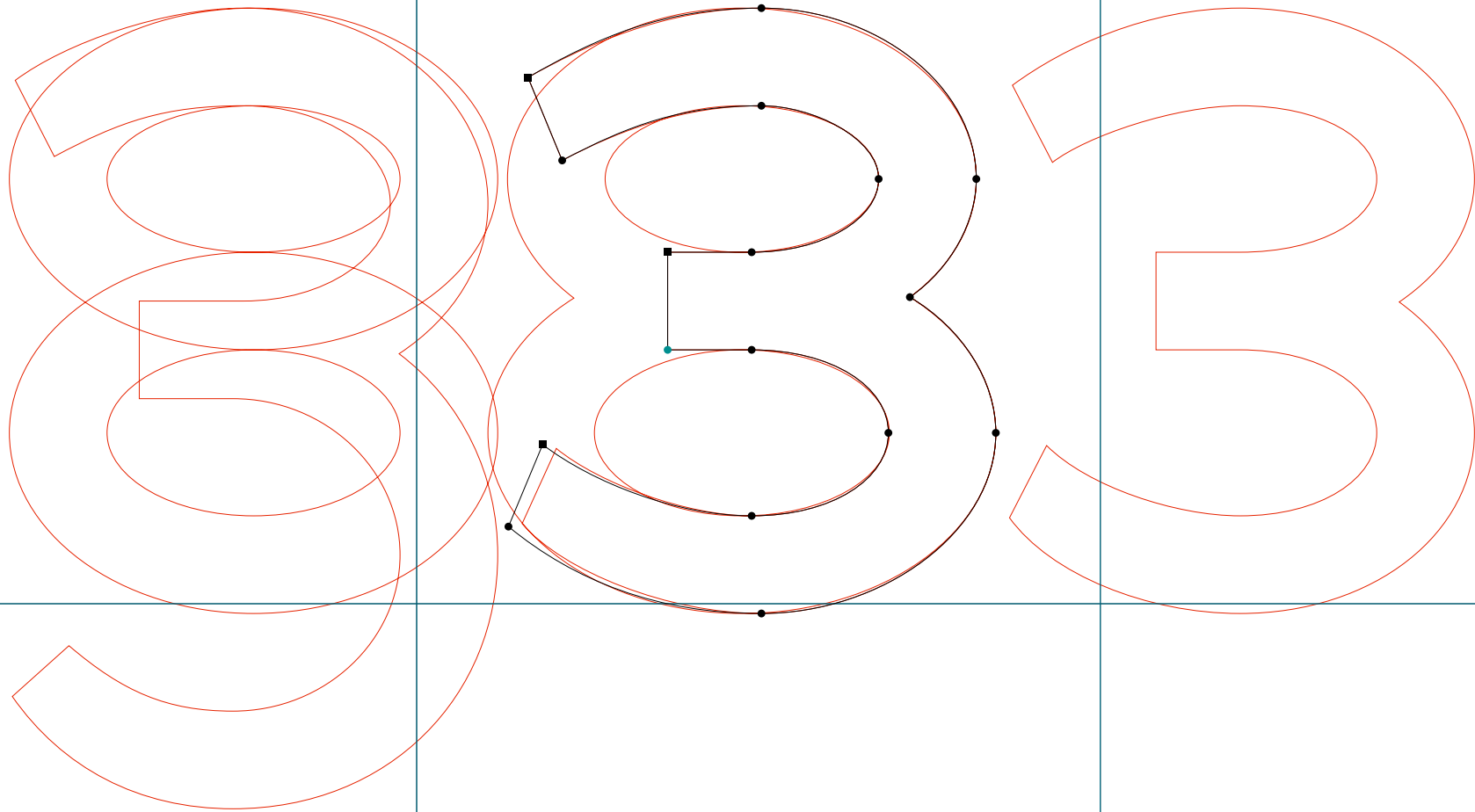

**BASE 9 & 12**

.....  
BaseTwelve SerifSmallcaps | five | RoboFog Sketches | 1995 | Emigre Fonts

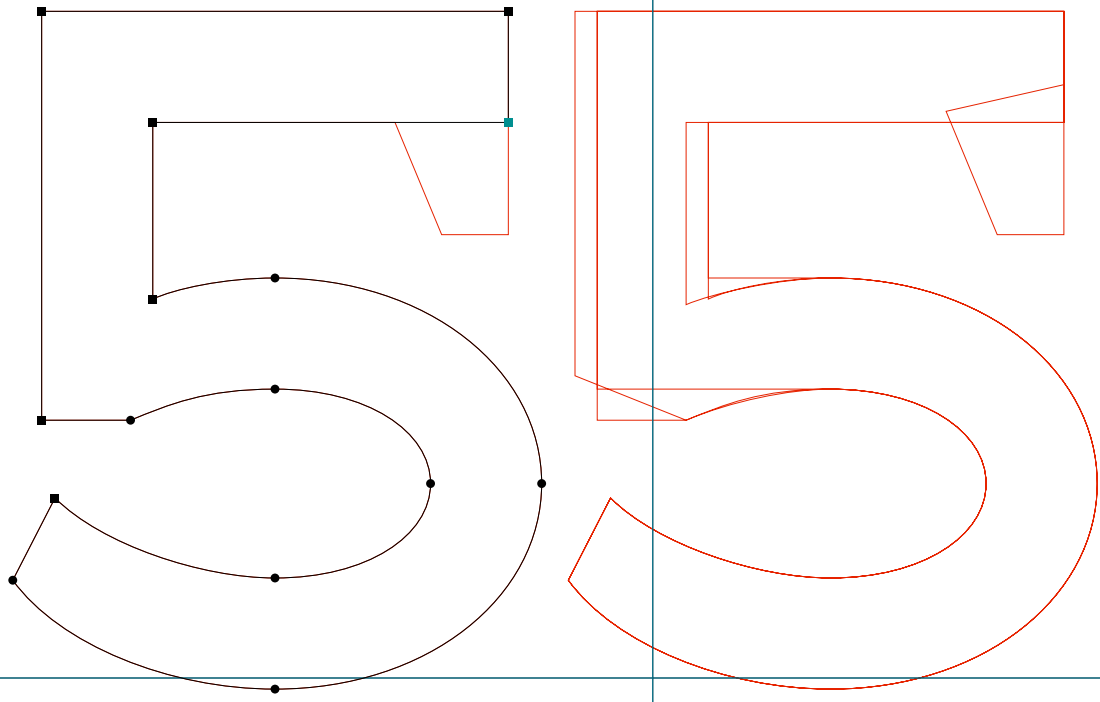

**BASE 9 & 12**

.....  
BaseTwelve SerifSmallcaps | six | RoboFog Sketches | 1995 | Emigre Fonts

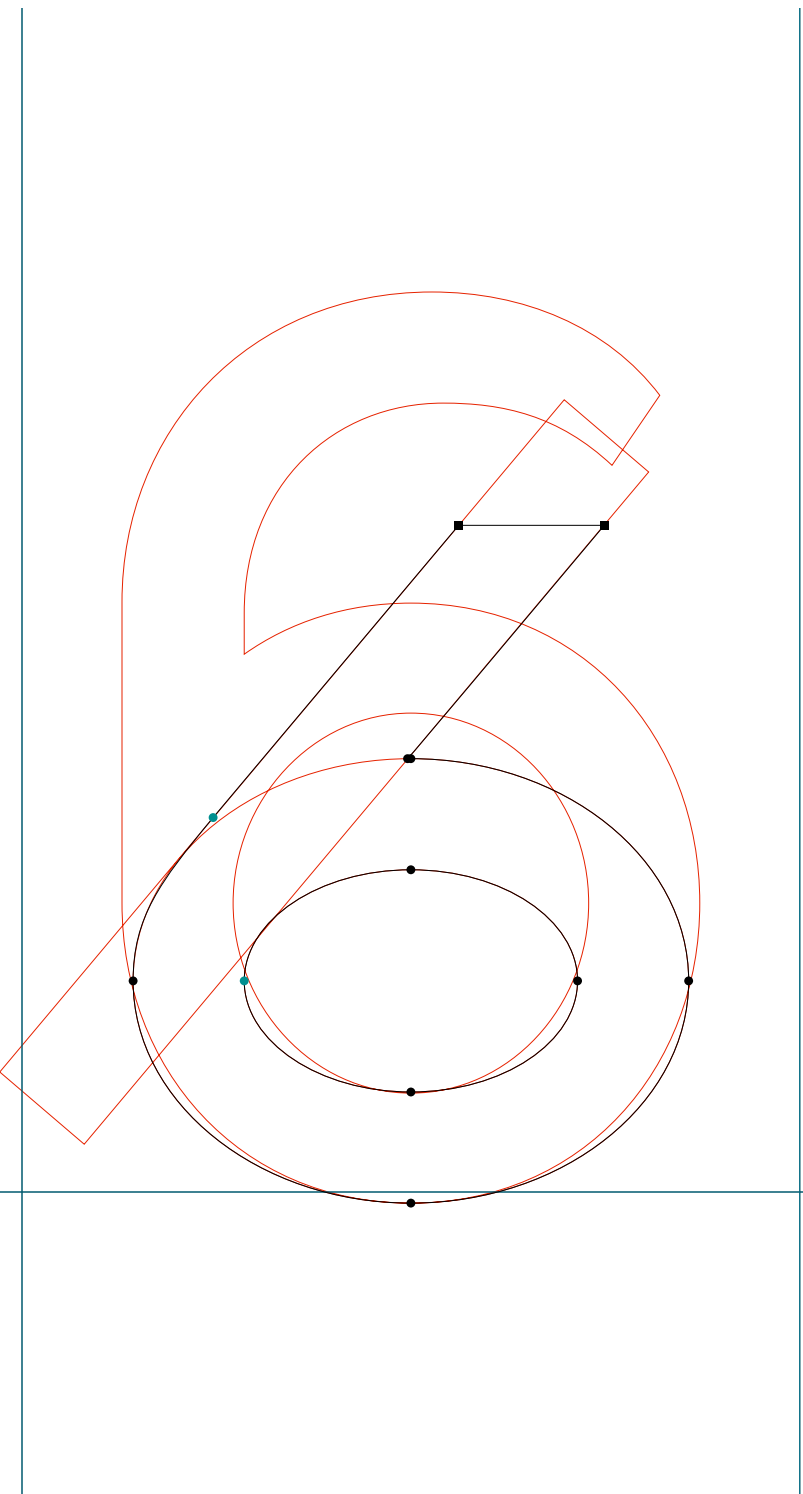



**BASE 9 & 12**

.....  
BaseTwelve SerifSmallcaps | S | RoboFog Sketches | 1995 | Emigre Fonts

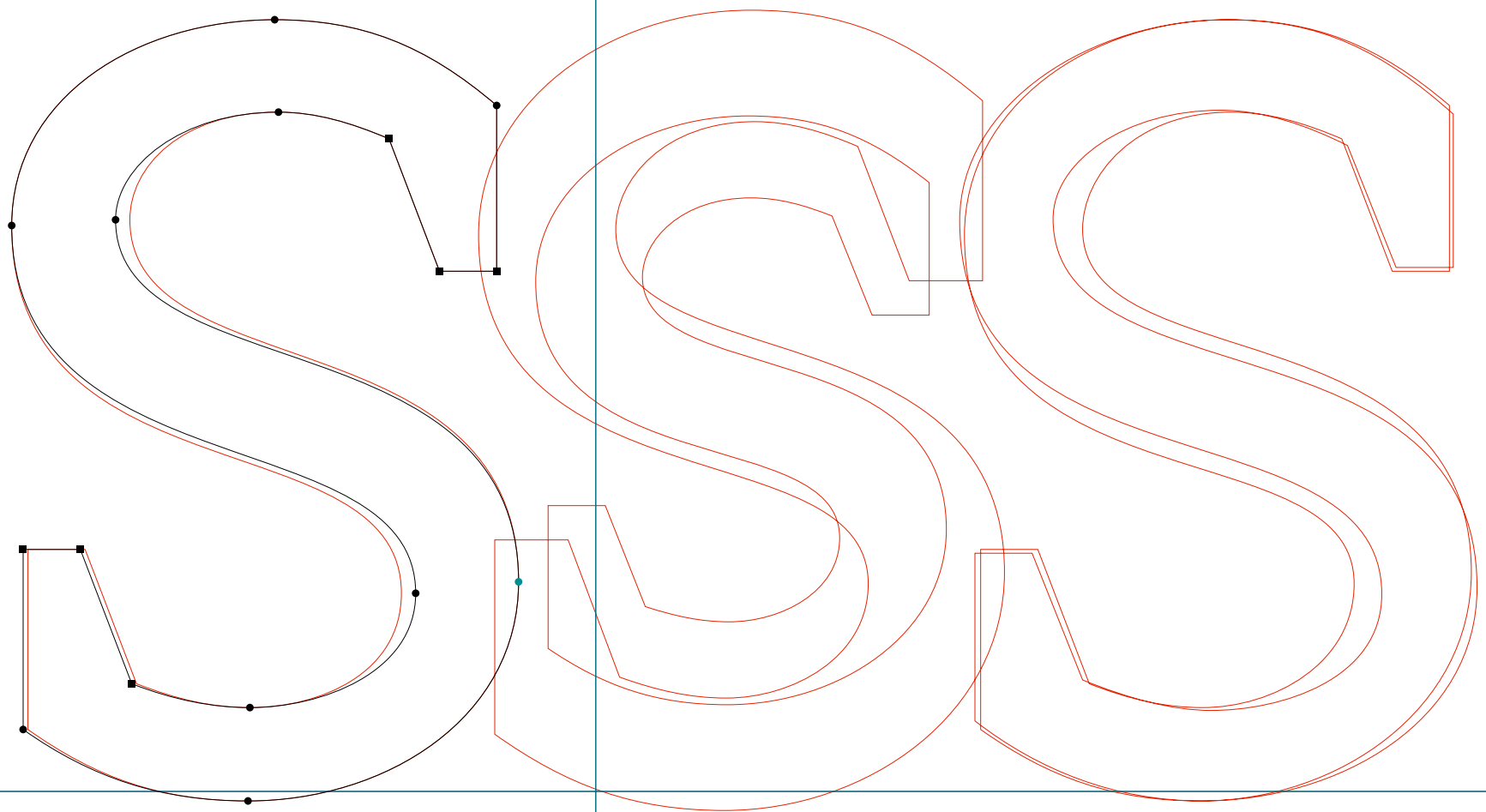

**BASE 9 & 12**

.....  
BaseTwelve SerifSmallcaps | a | RoboFog Sketches | 1995 | Emigre Fonts

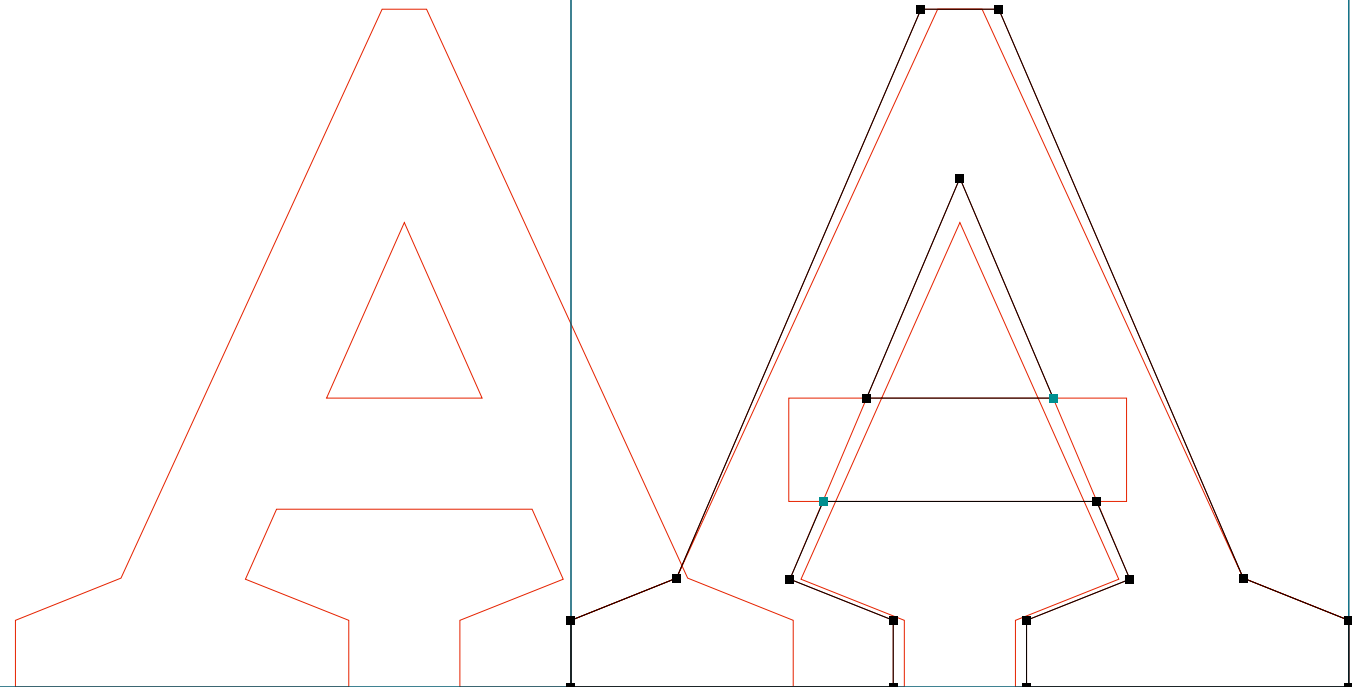

**BASE 9 & 12**

.....  
BaseTwelve SerifSmallcaps | b | RoboFog Sketches | 1995 | Emigre Fonts

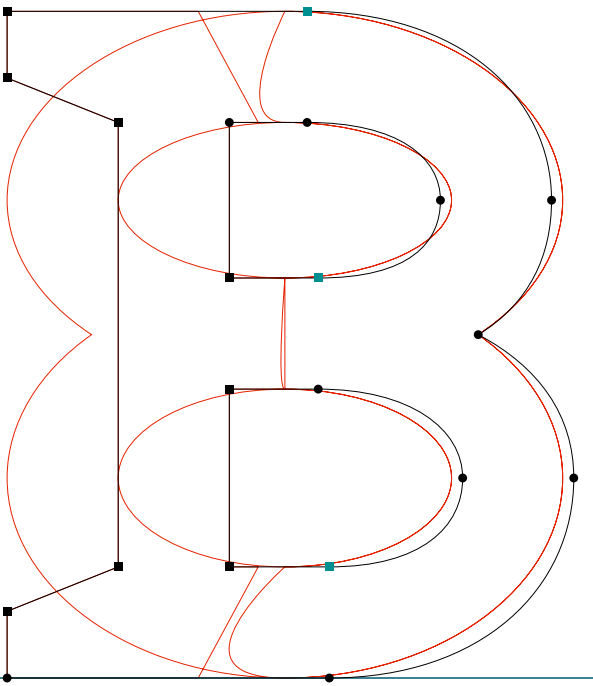

**BASE 9 & 12**

.....  
BaseTwelve SerifSmallcaps | d | RoboFog Sketches | 1995 | Emigre Fonts

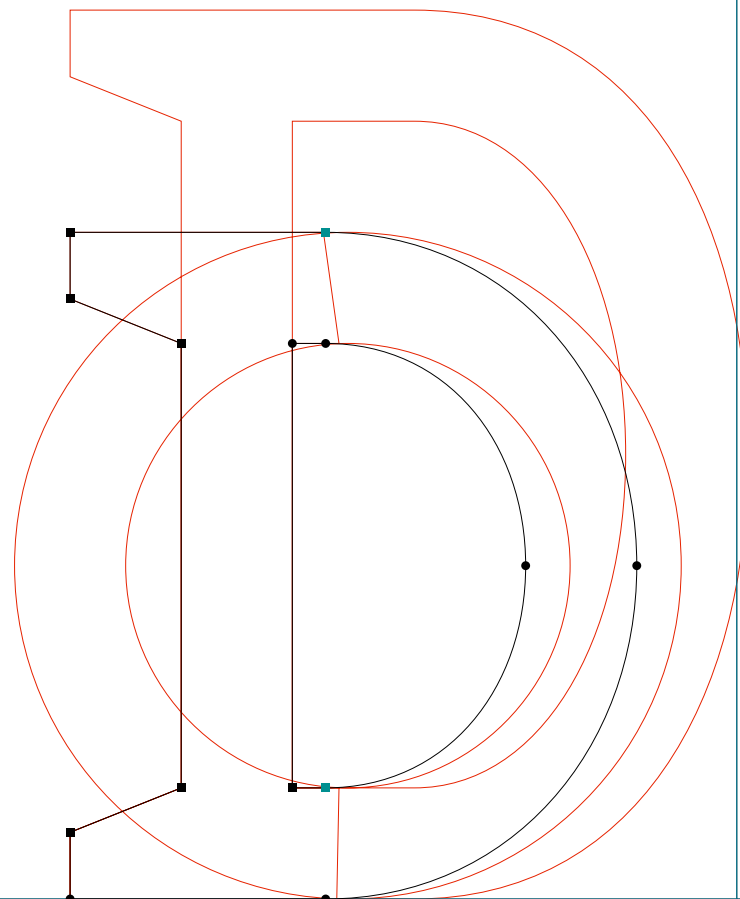

**BASE 9 & 12**

.....  
BaseTwelve SerifSmallcaps | g | RoboFog Sketches | 1995 | Emigre Fonts

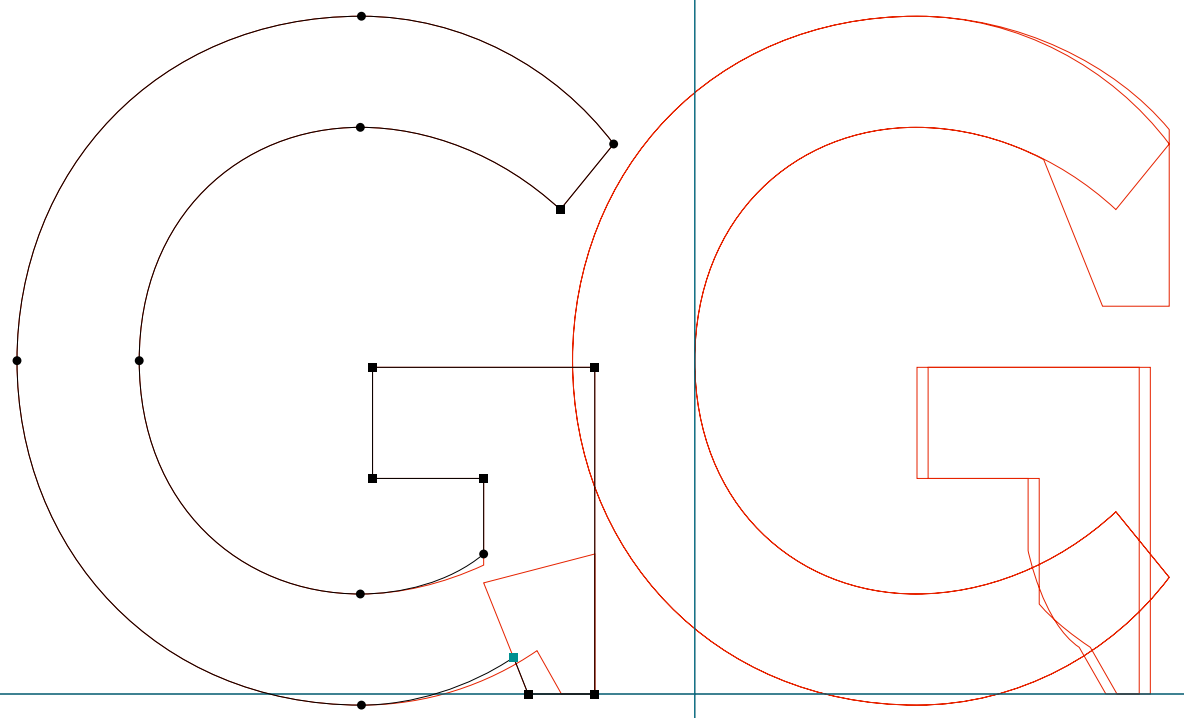

**BASE 9 & 12**

.....  
BaseTwelve SerifI | f | RoboFog Sketches | 1995 | Emigre Fonts



**BASE 9 & 12**

.....  
BaseTwelve SerifB | three | RoboFog Sketches | 1995 | Emigre Fonts

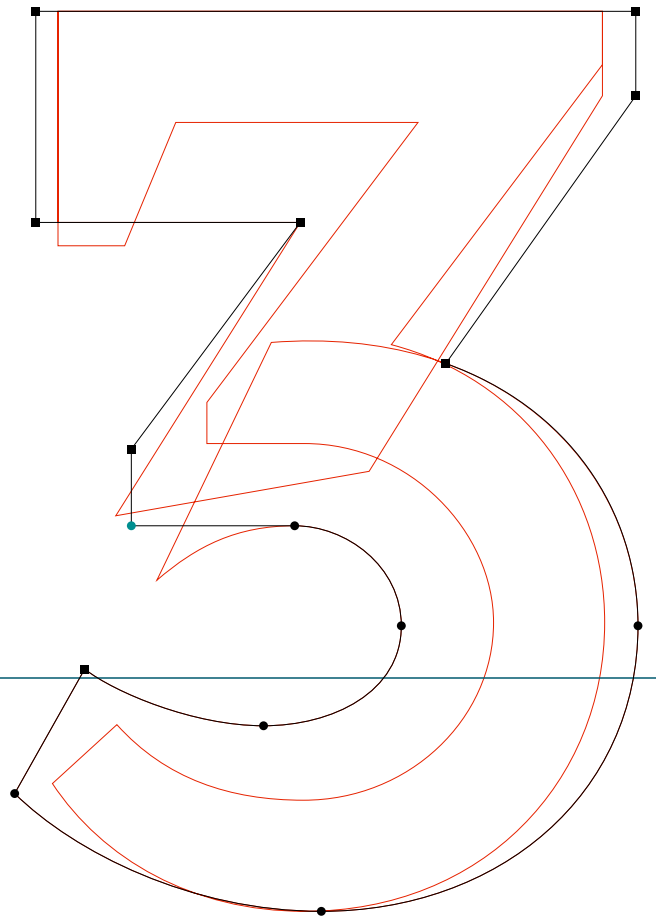

**BASE 9 & 12**

.....  
BaseTwelve SerifB | five | RoboFog Sketches | 1995 | Emigre Fonts

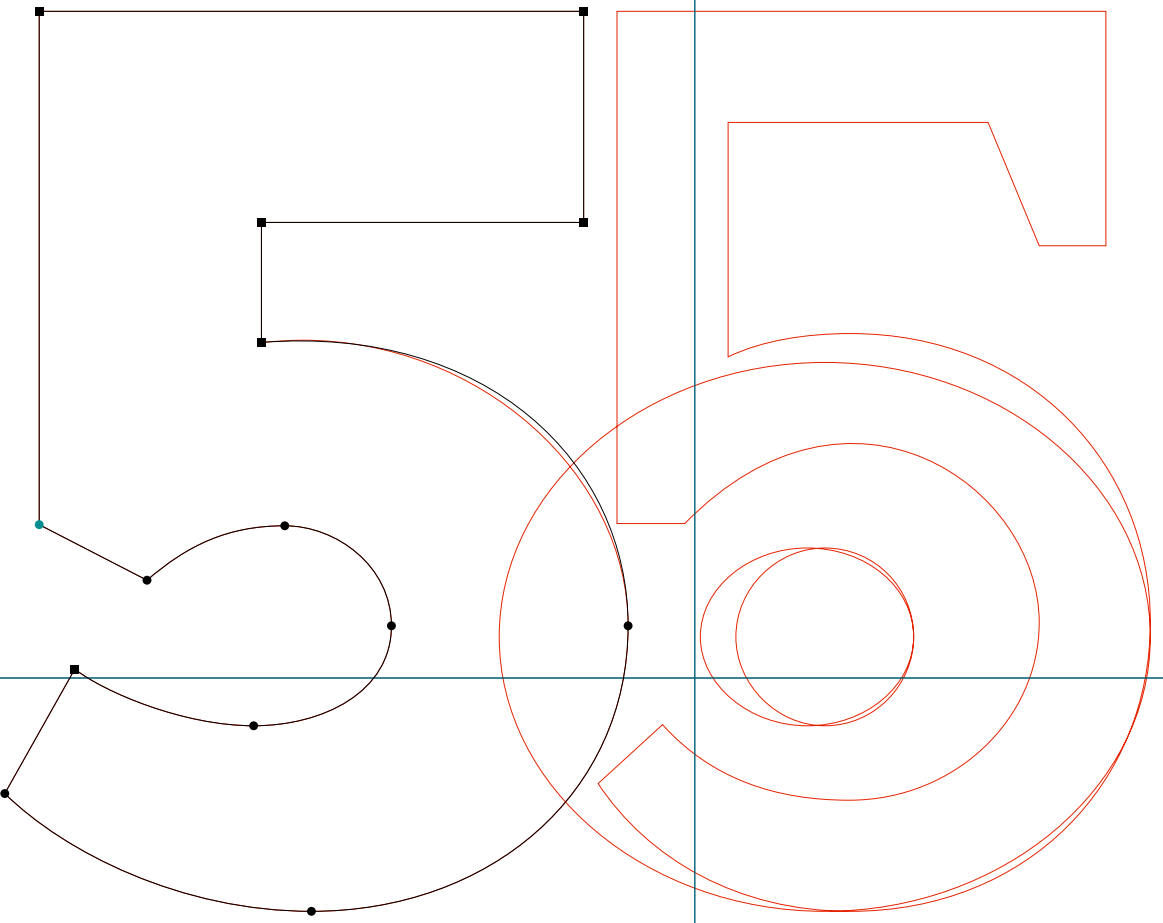



**BASE 9 & 12**

.....  
BaseTwelve SerifB | six | RoboFog Sketches | 1995 | Emigre Fonts

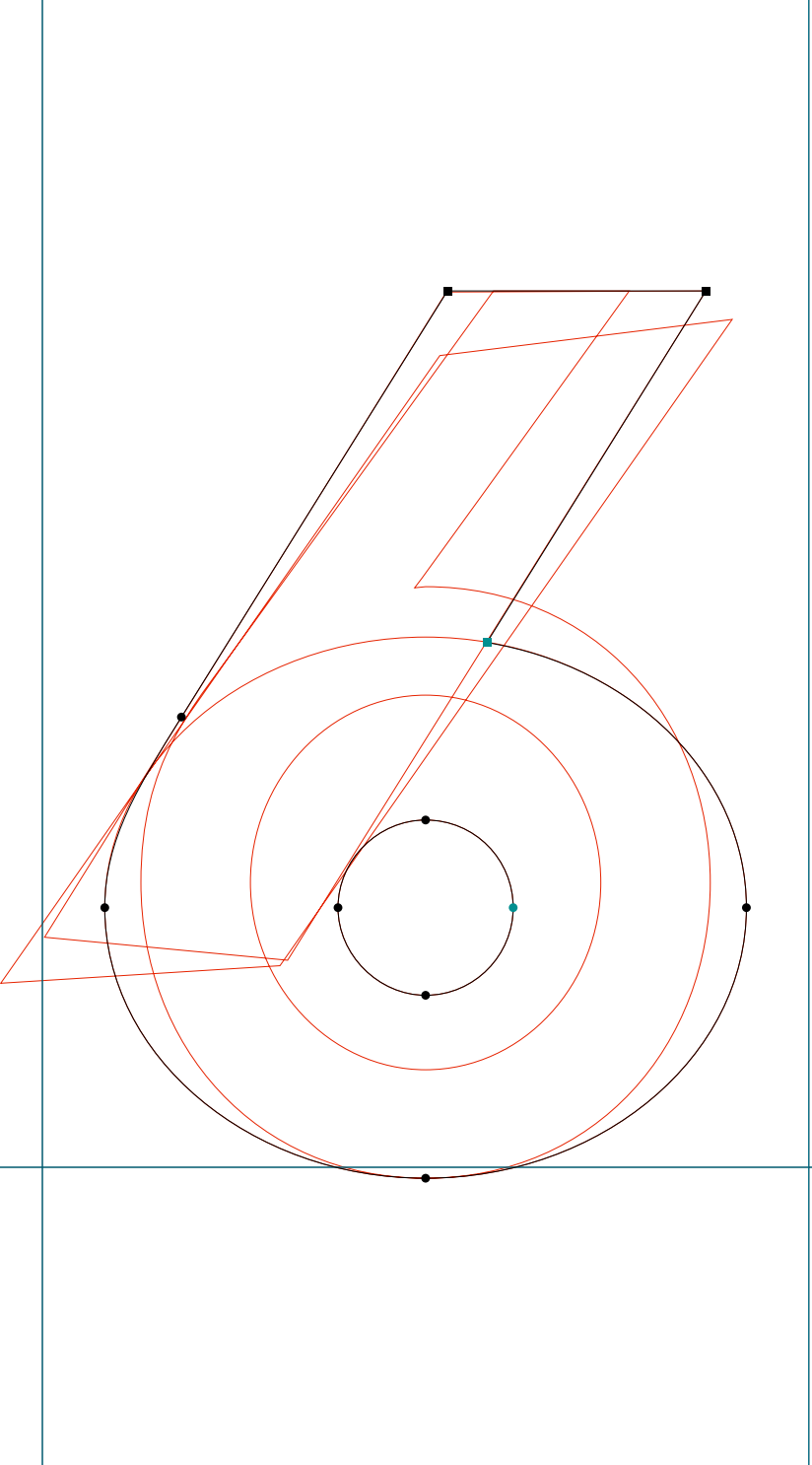

**BASE 9 & 12**

.....  
BaseTwelve SerifB | eight | RoboFog Sketches | 1995 | Emigre Fonts

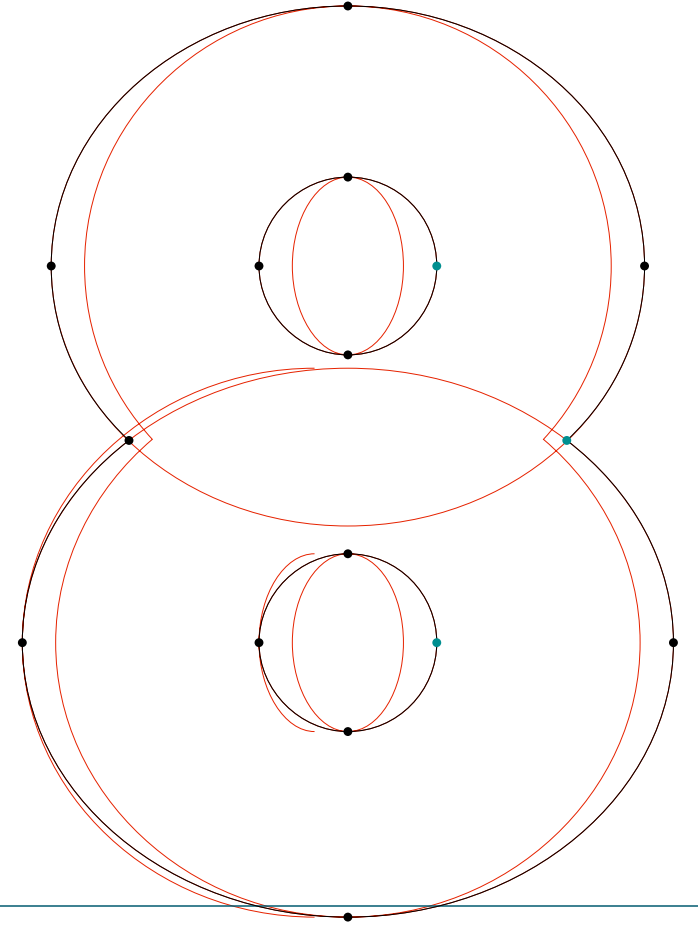

**BASE 9 & 12**

.....  
BaseTwelve SerifB | A | RoboFog Sketches | 1995 | Emigre Fonts

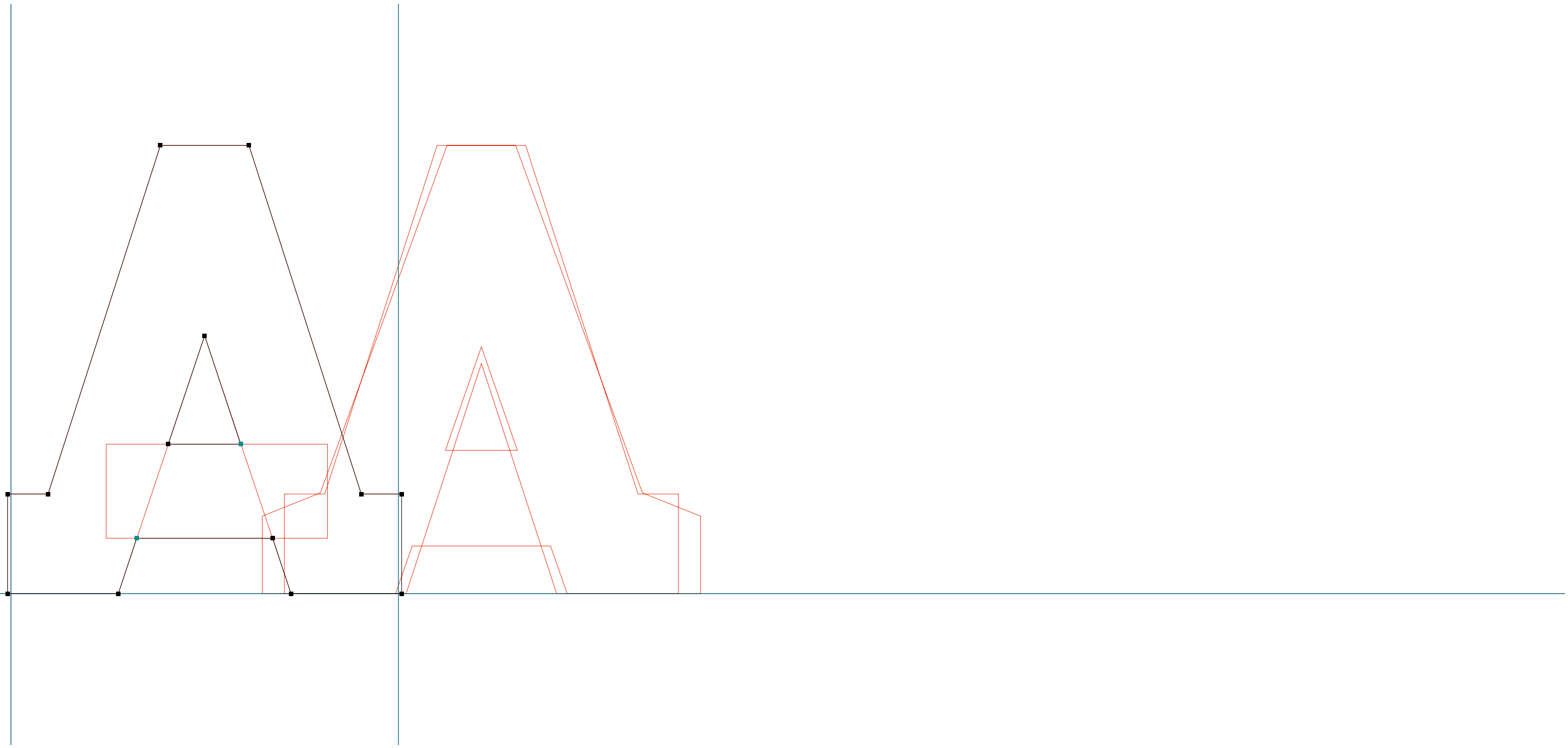

**BASE 9 & 12**

.....  
BaseTwelve SerifB | B | RoboFog Sketches | 1995 | Emigre Fonts

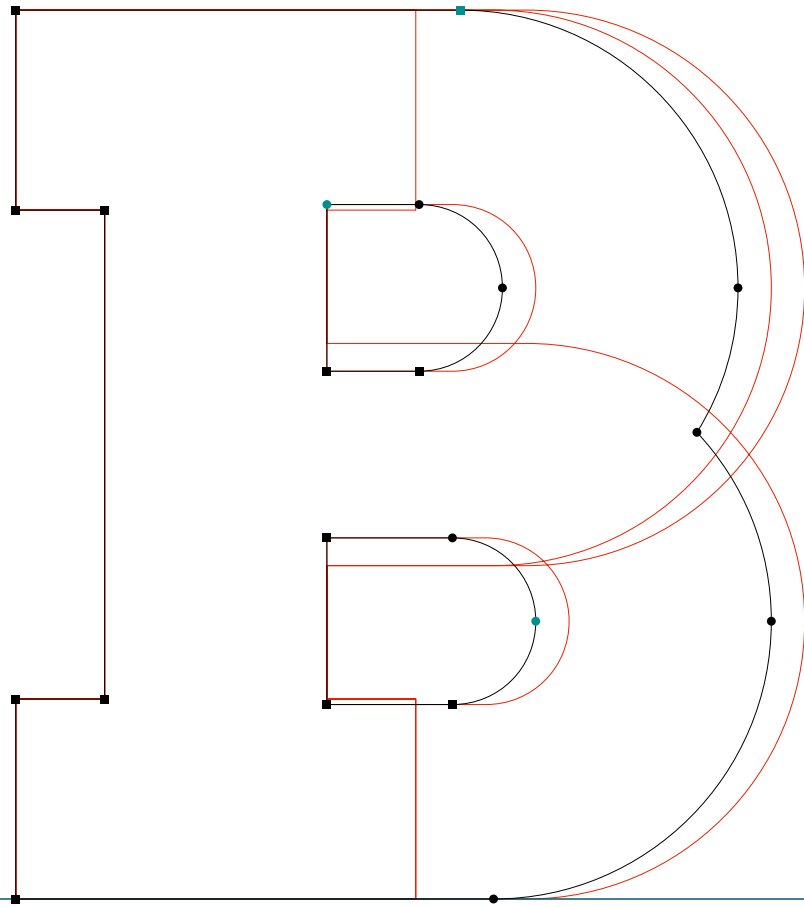

**BASE 9 & 12**

.....  
BaseTwelve SerifB | C | RoboFog Sketches | 1995 | Emigre Fonts

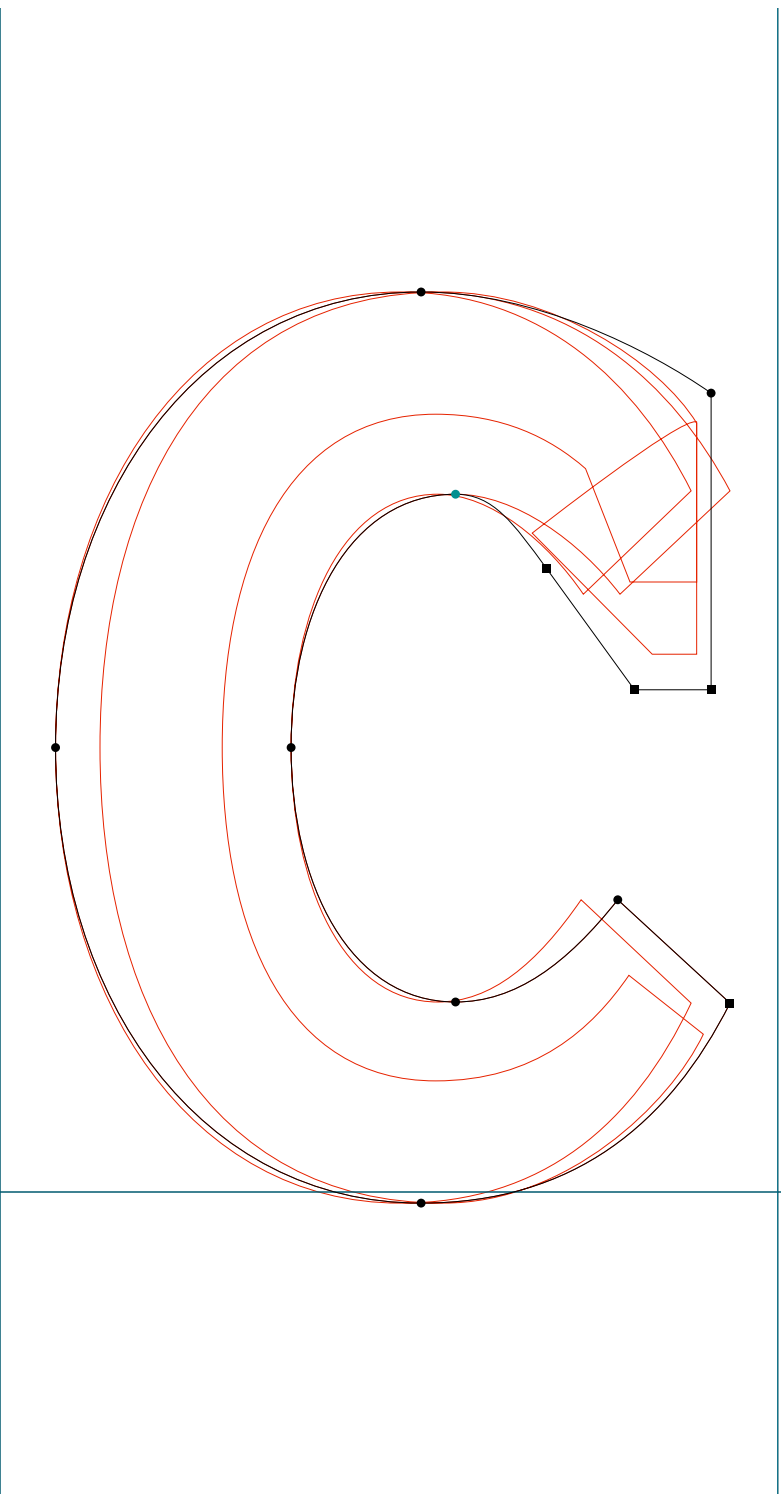

**BASE 9 & 12**

.....  
BaseTwelve SerifB | G | RoboFog Sketches | 1995 | Emigre Fonts



**BASE 9 & 12**

.....  
BaseTwelve SerifB | H | RoboFog Sketches | 1995 | Emigre Fonts

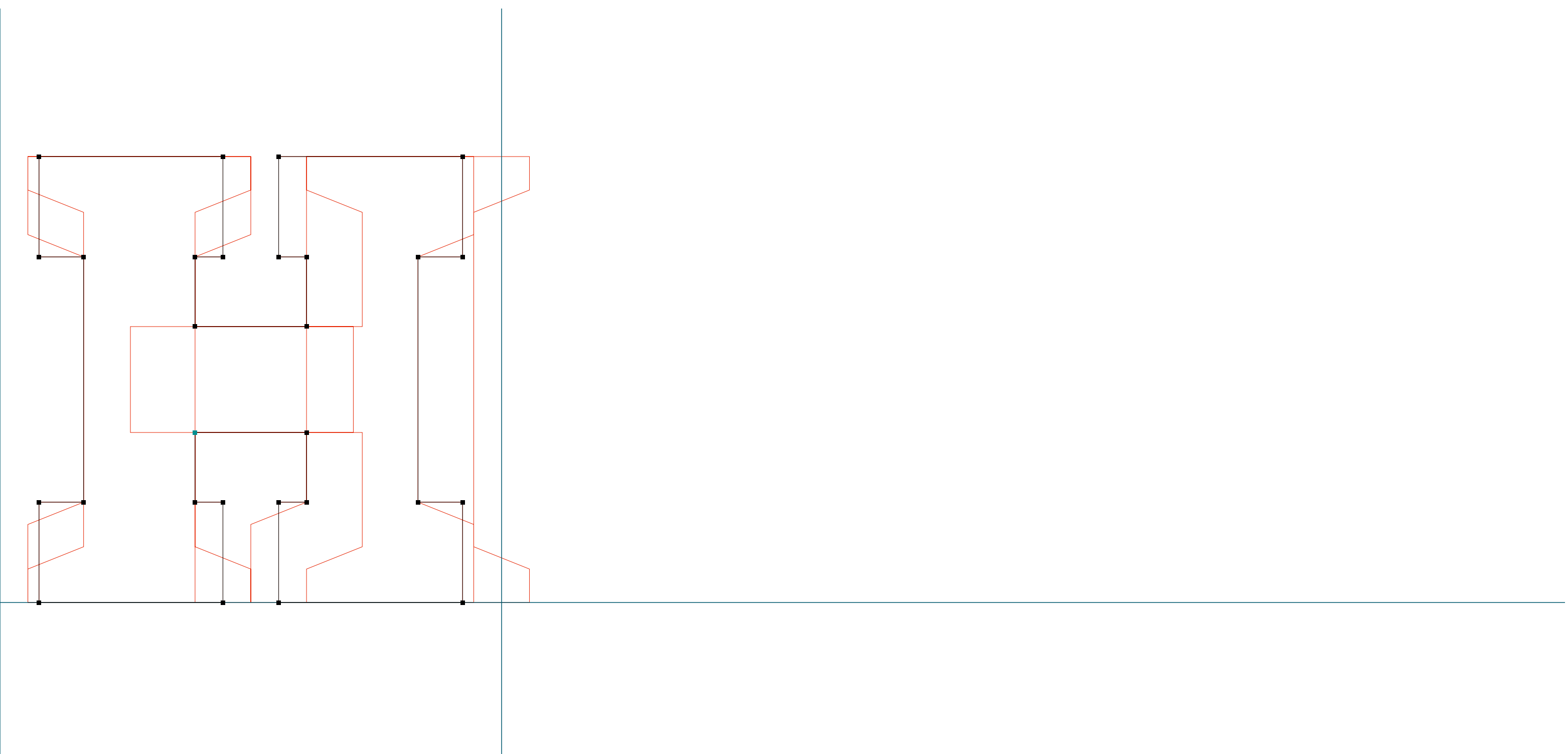

**BASE 9 & 12**

.....  
BaseTwelve SerifB | I | RoboFog Sketches | 1995 | Emigre Fonts

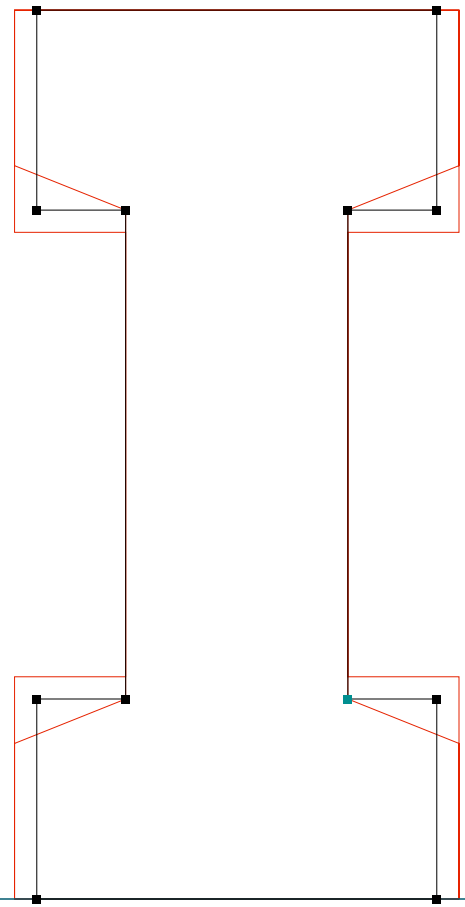
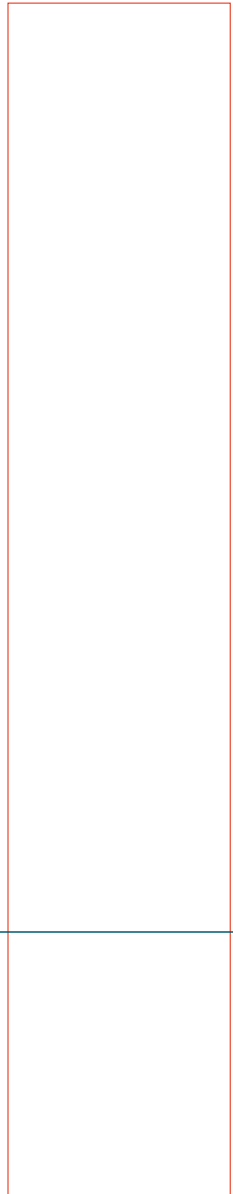



**BASE 9 & 12**

.....  
BaseTwelve SerifB | K | RoboFog Sketches | 1995 | Emigre Fonts

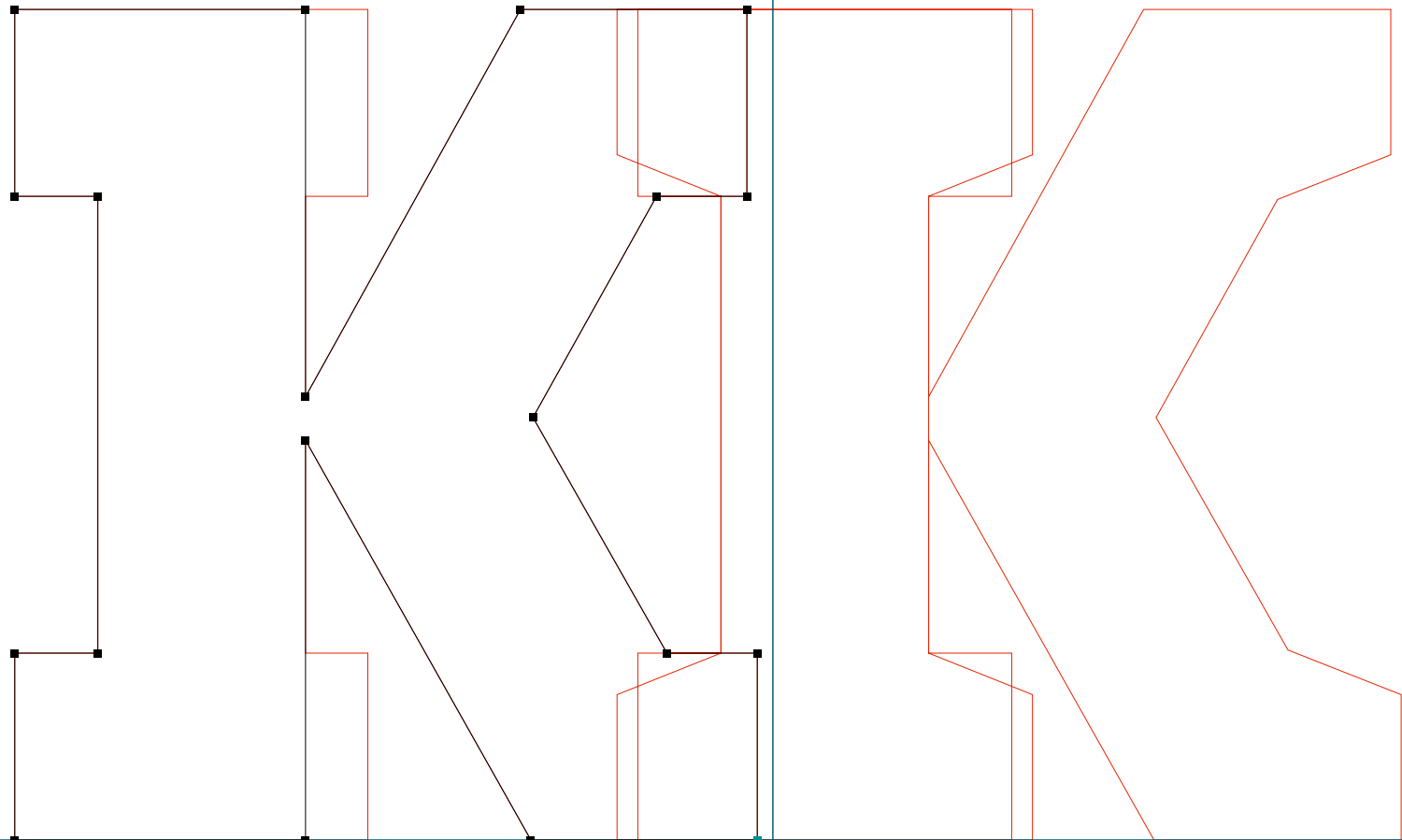

**BASE 9 & 12**

.....  
BaseTwelve SerifB | T | RoboFog Sketches | 1995 | Emigre Fonts

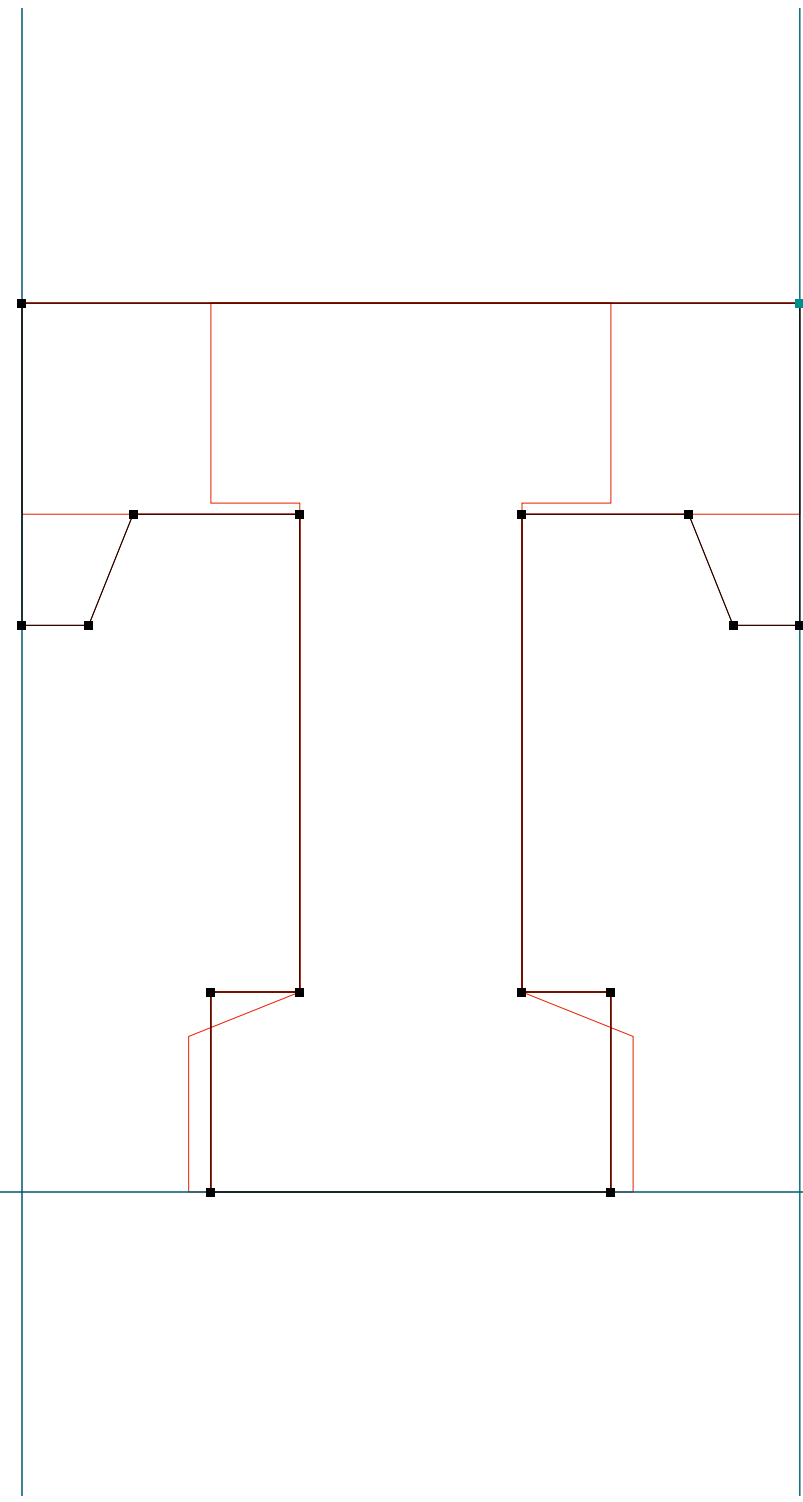

**BASE 9 & 12**

.....  
BaseTwelve SerifB | W | RoboFog Sketches | 1995 | Emigre Fonts

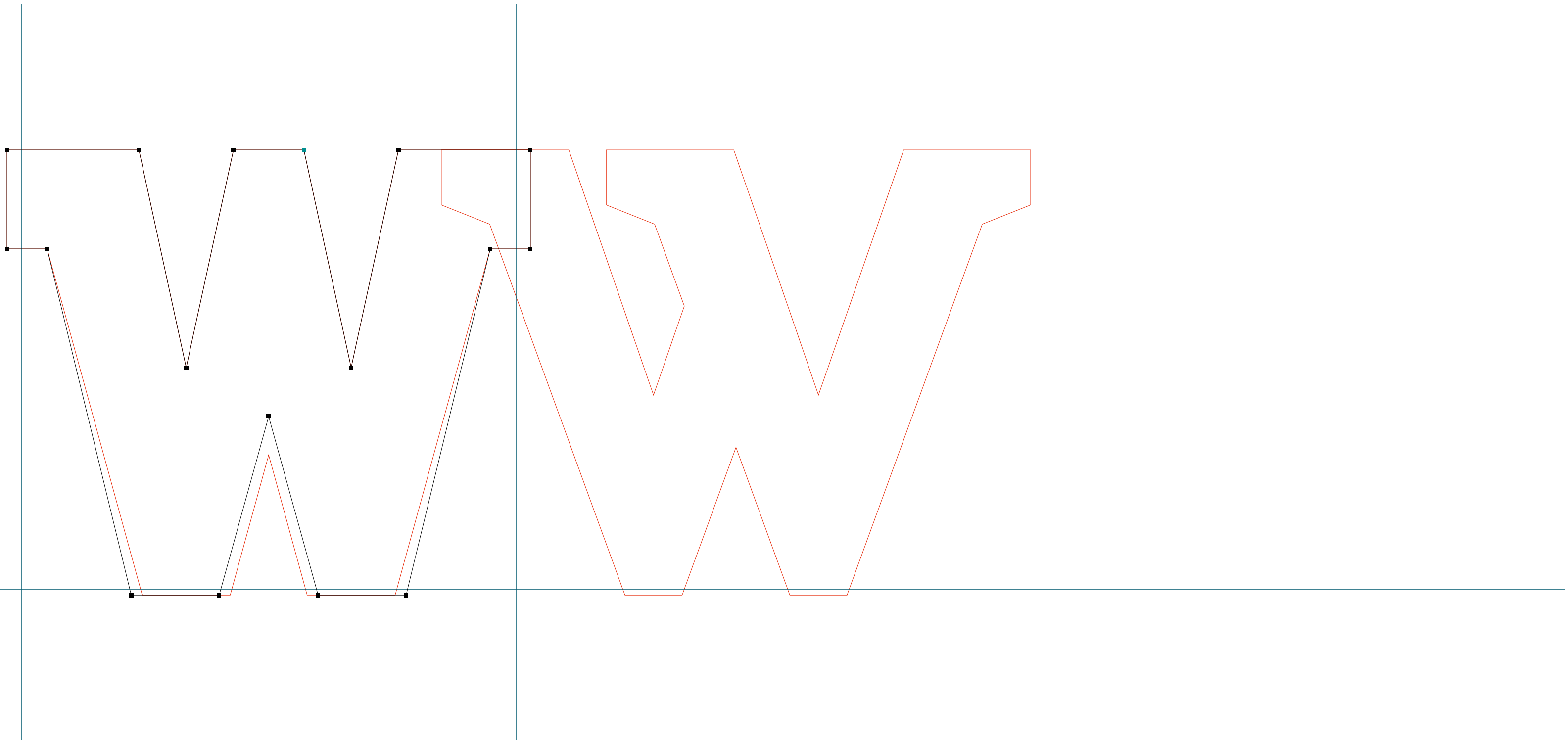

**BASE 9 & 12**

.....  
BaseTwelve SerifB | a | RoboFog Sketches | 1995 | Emigre Fonts

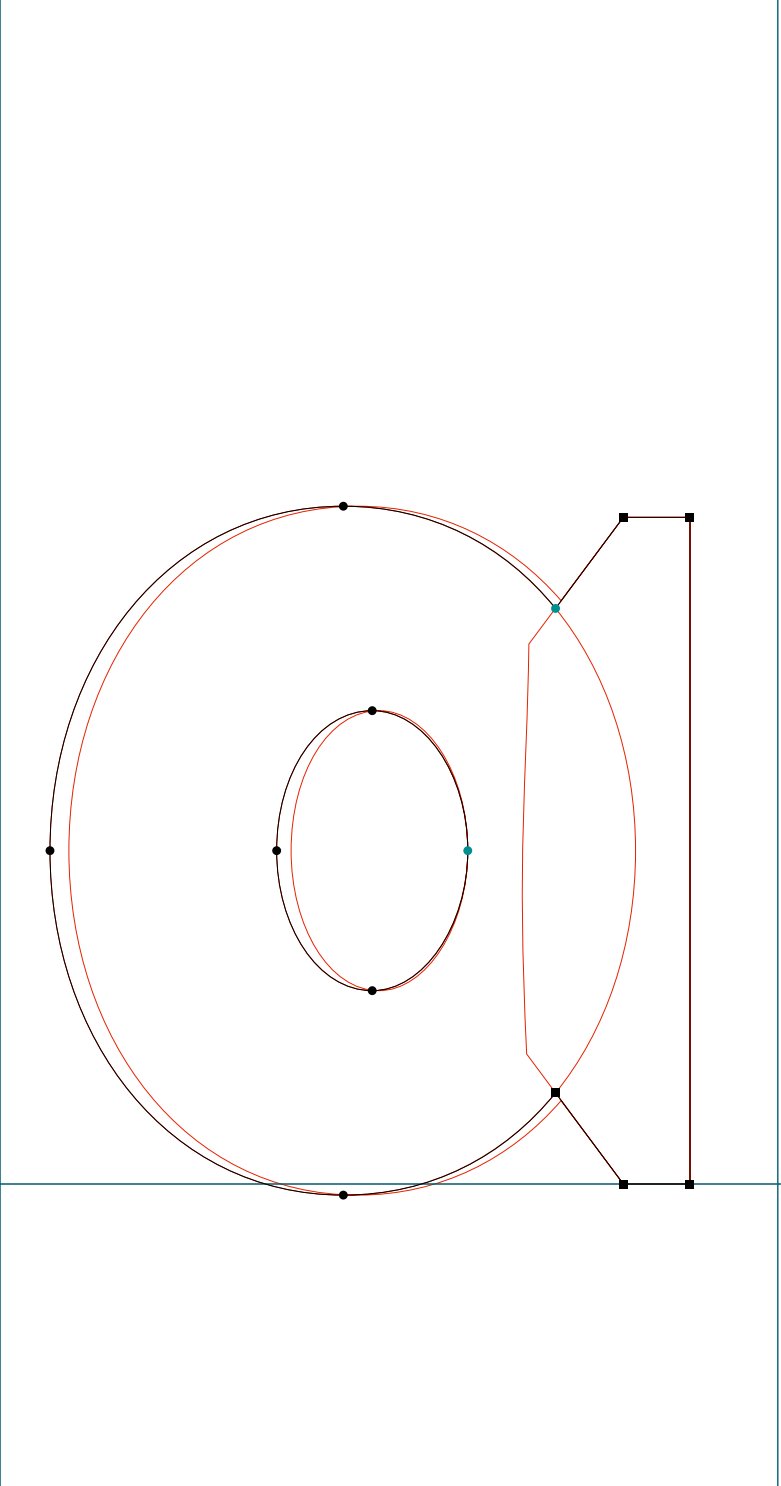

**BASE 9 & 12**

.....  
BaseTwelve SerifB | b | RoboFog Sketches | 1995 | Emigre Fonts

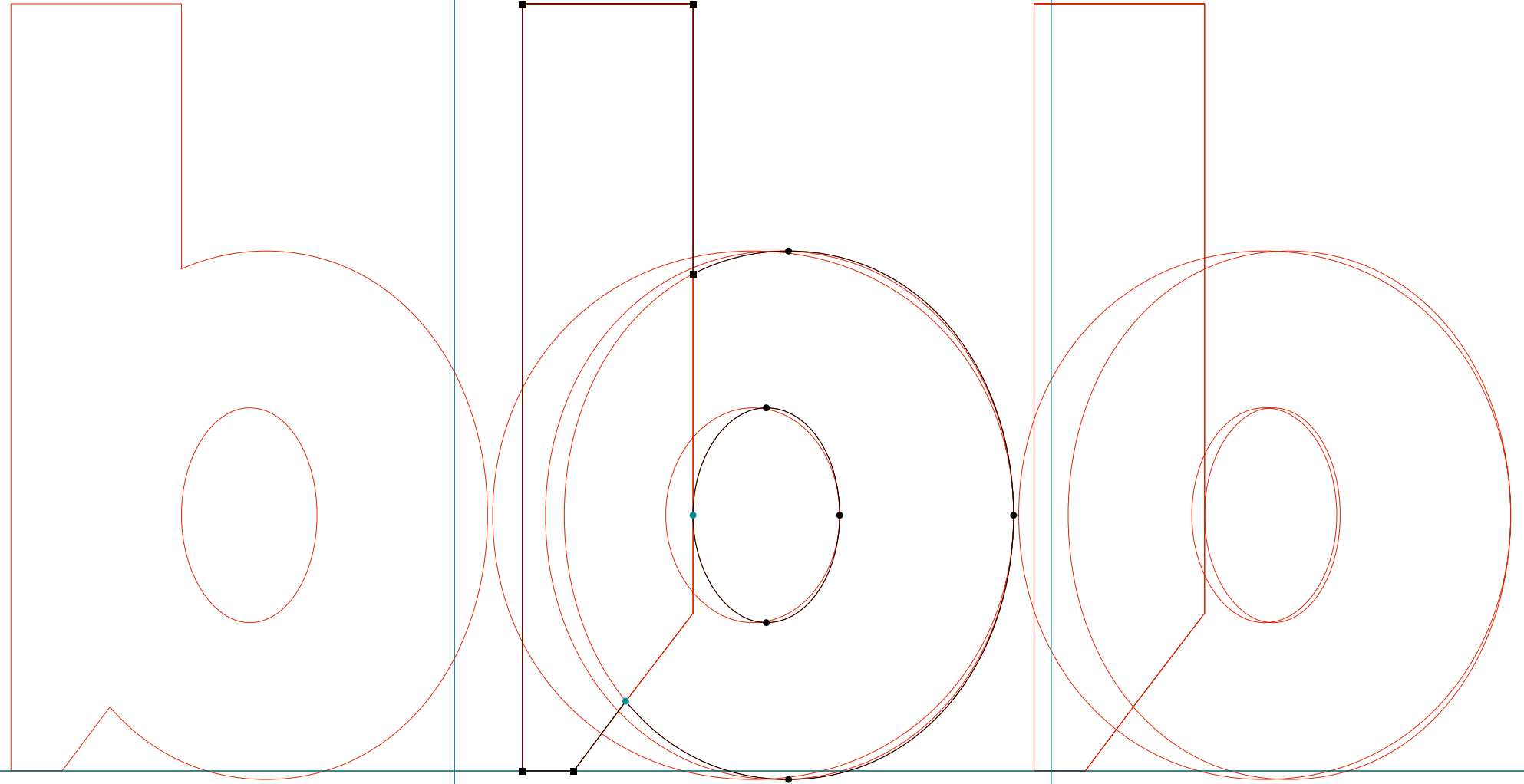

**BASE 9 & 12**

BaseTwelve SerifB | c | RoboFog Sketches | 1995 | Emigre Fonts

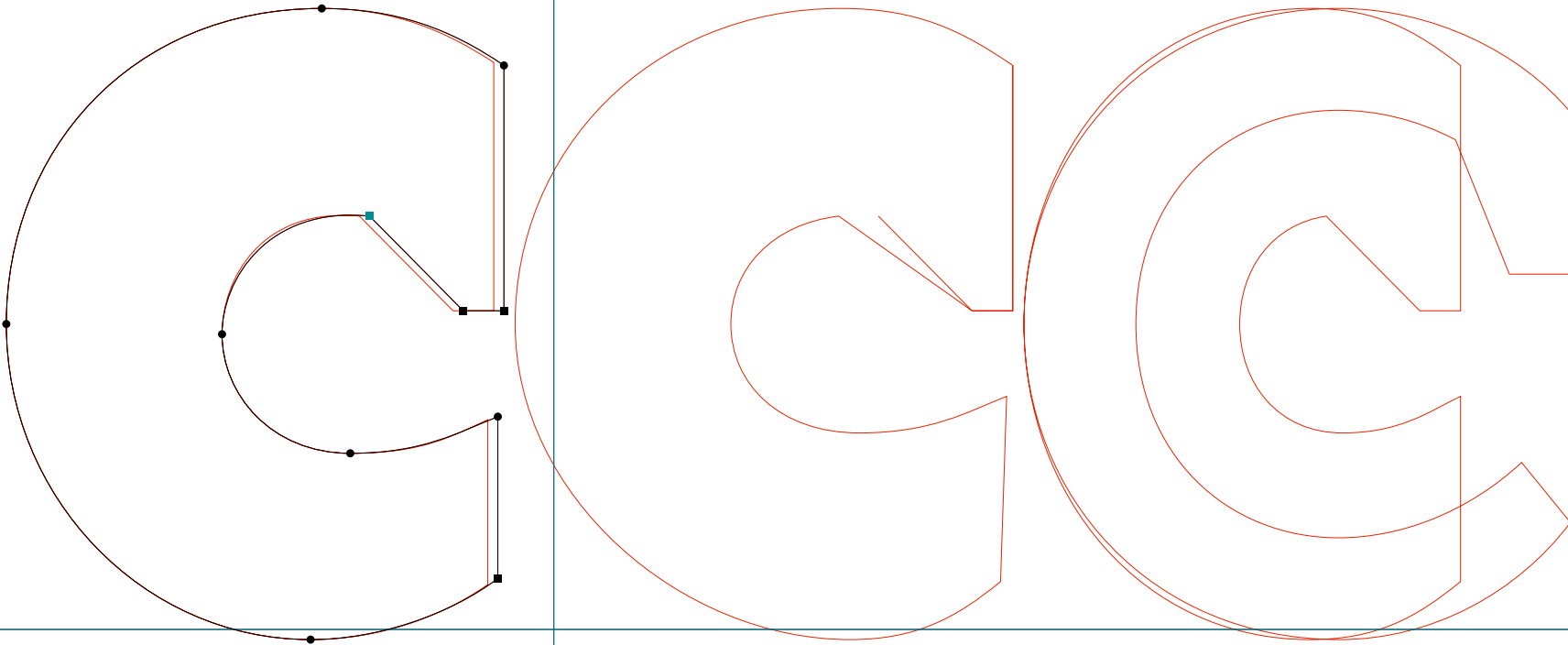

**BASE 9 & 12**

.....  
BaseTwelve SerifB | e | RoboFog Sketches | 1995 | Emigre Fonts

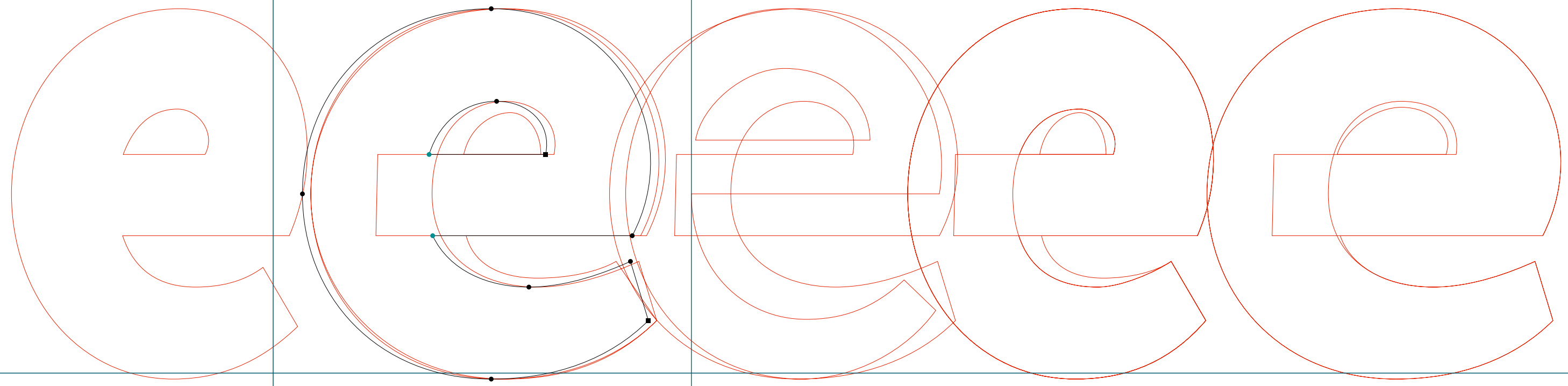

**BASE 9 & 12**

.....  
BaseTwelve SerifB | g | RoboFog Sketches | 1995 | Emigre Fonts

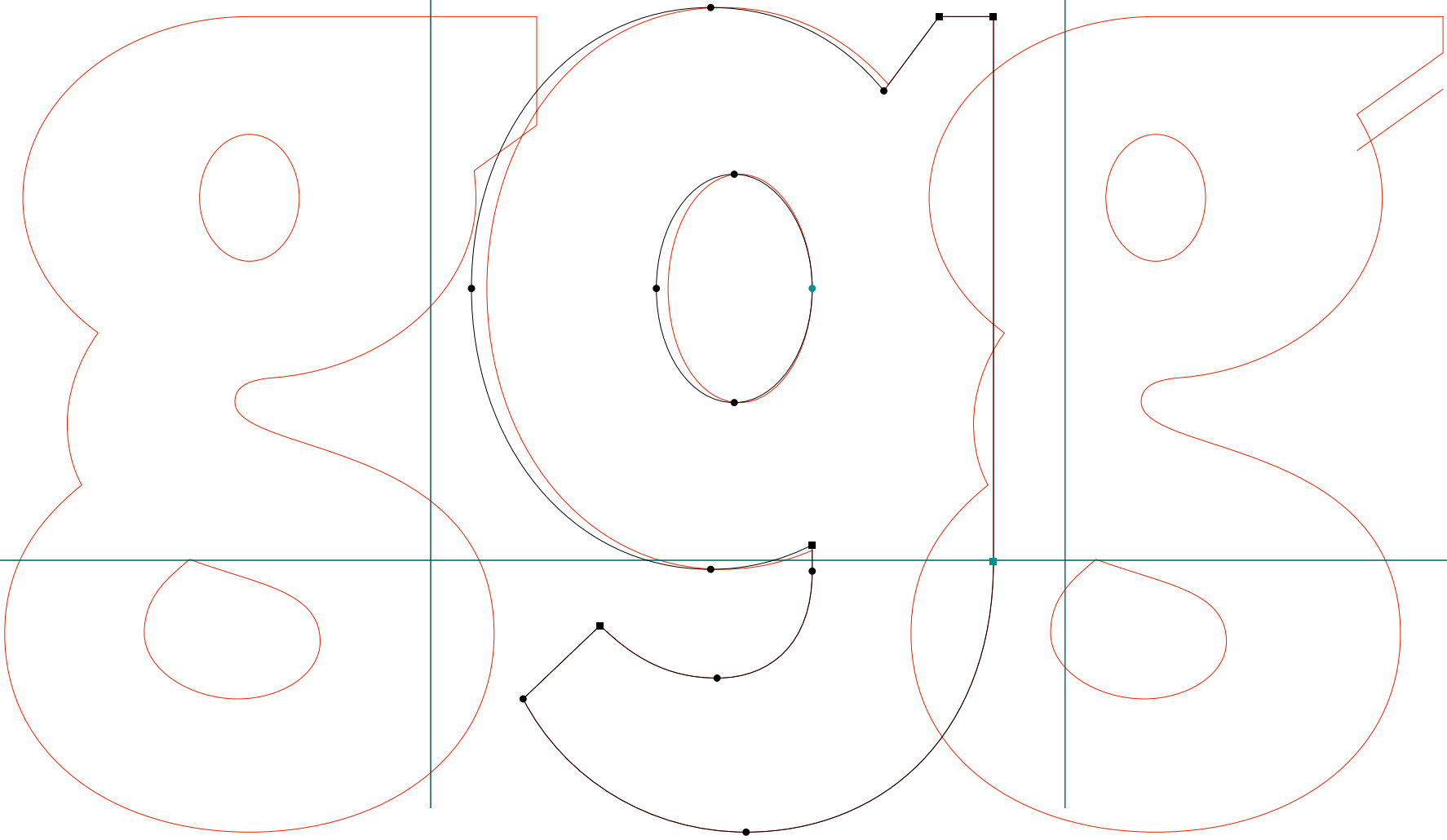



**BASE 9 & 12**

BaseTwelve SerifB | h | RoboFog Sketches | 1995 | Emigre Fonts

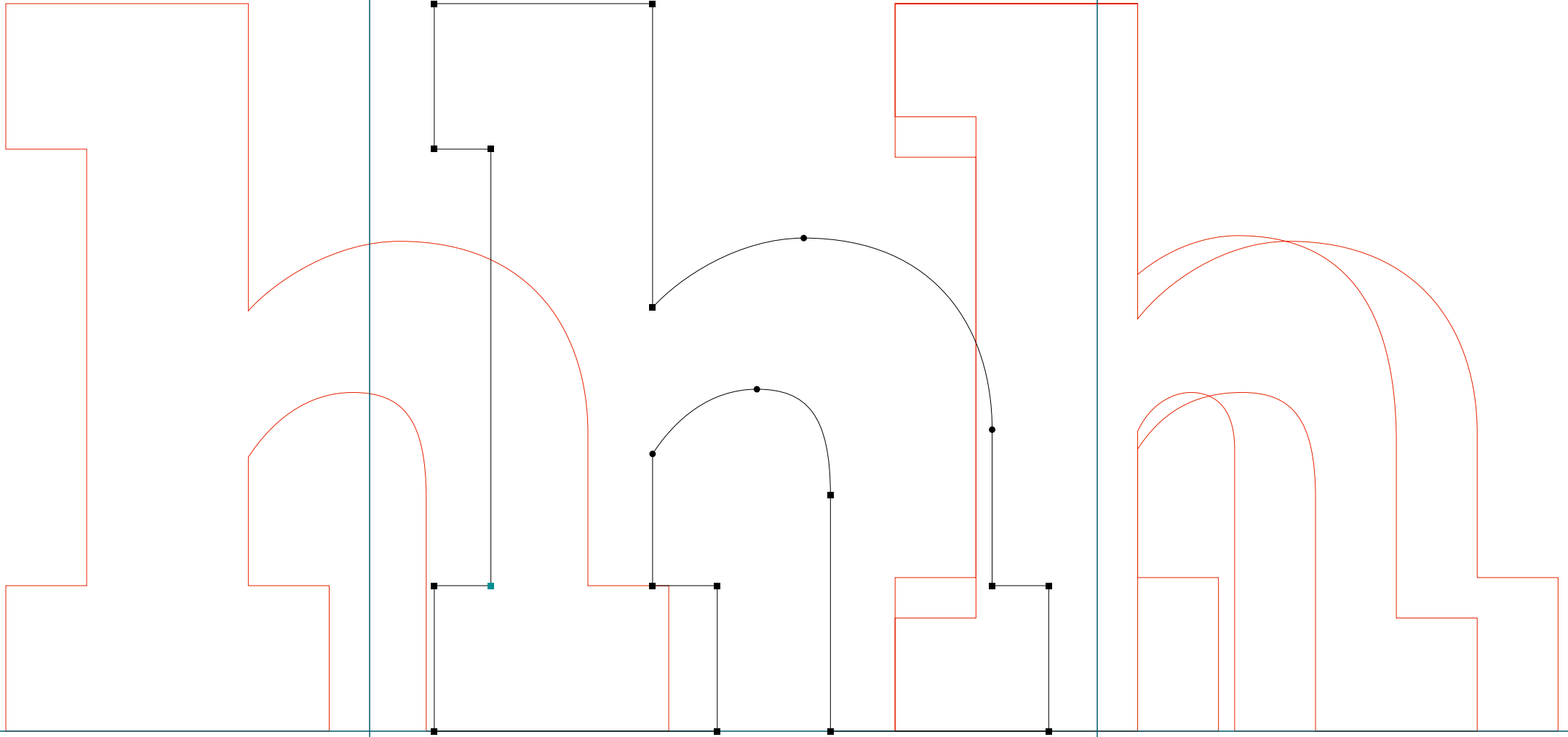

**BASE 9 & 12**

.....  
BaseTwelve SerifB | i | RoboFog Sketches | 1995 | Emigre Fonts

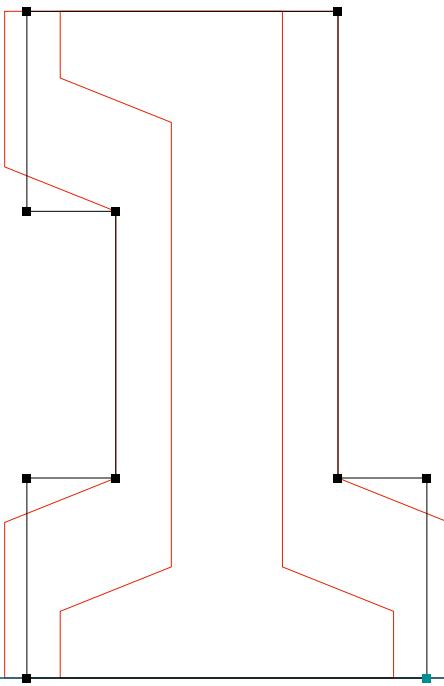
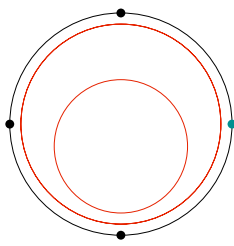

**BASE 9 & 12**

BaseTwelve SerifB | m | RoboFog Sketches | 1995 | Emigre Fonts

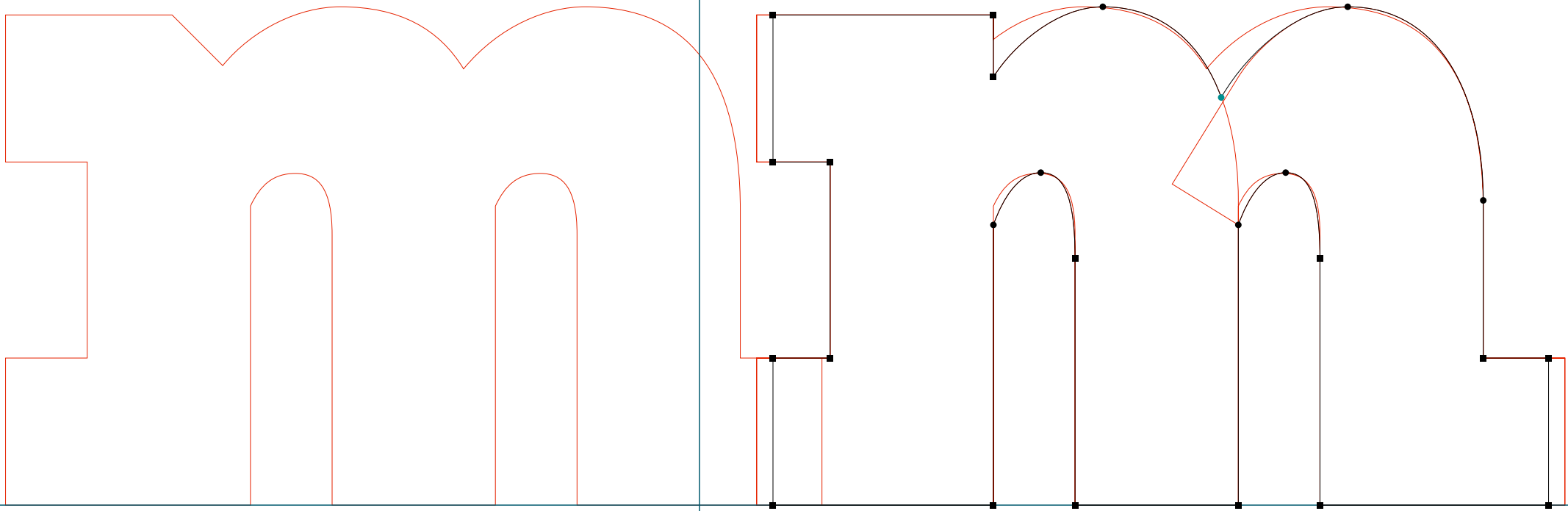

**BASE 9 & 12**

.....  
BaseTwelve SerifB | n | RoboFog Sketches | 1995 | Emigre Fonts

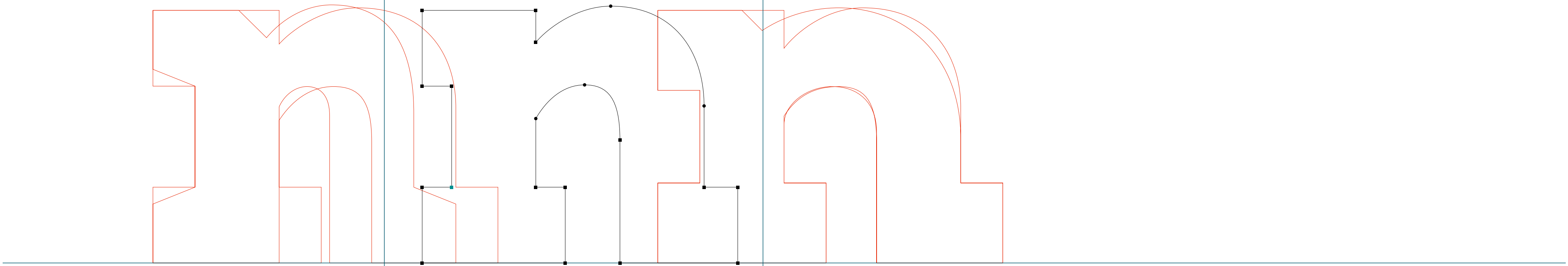

**BASE 9 & 12**

.....  
BaseTwelve SerifB | r | RoboFog Sketches | 1995 | Emigre Fonts

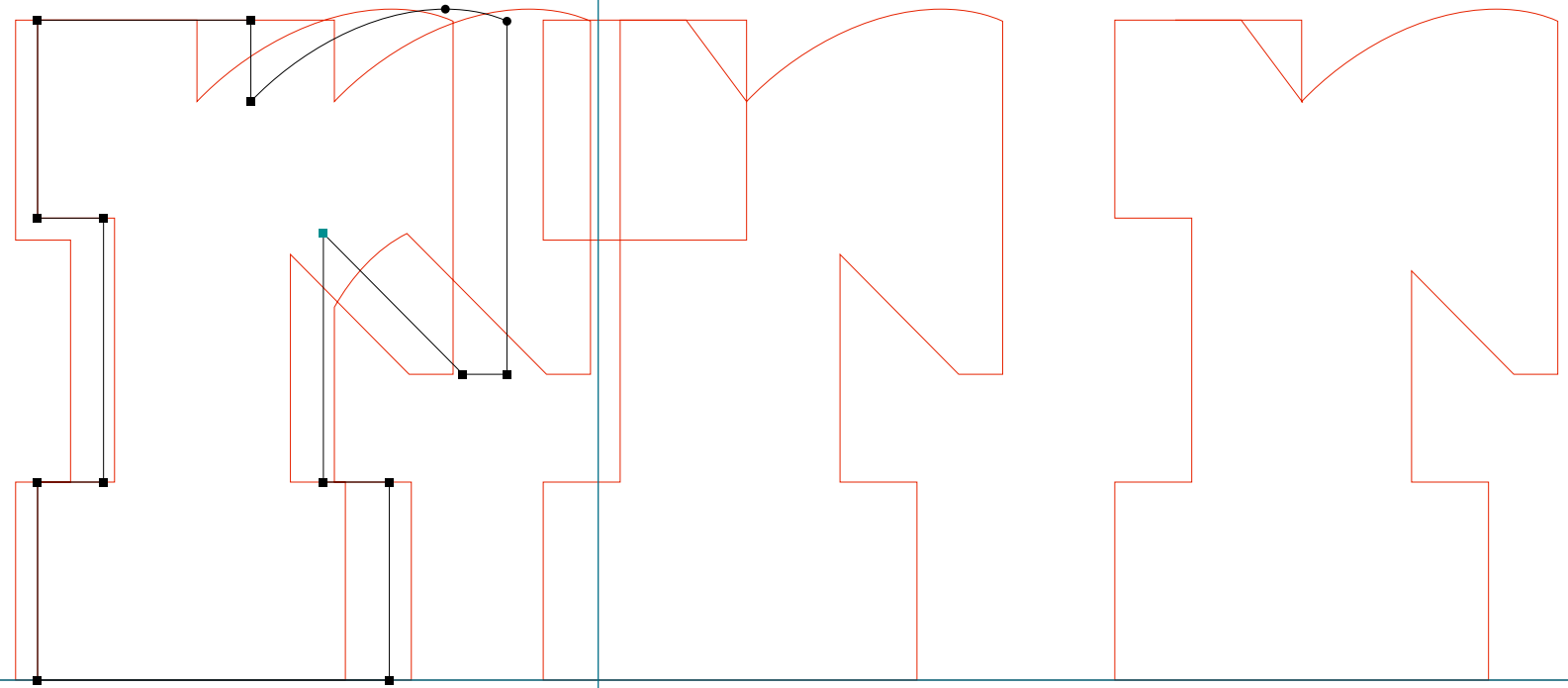

**BASE 9 & 12**

.....  
BaseTwelve SerifB | s | RoboFog Sketches | 1995 | Emigre Fonts

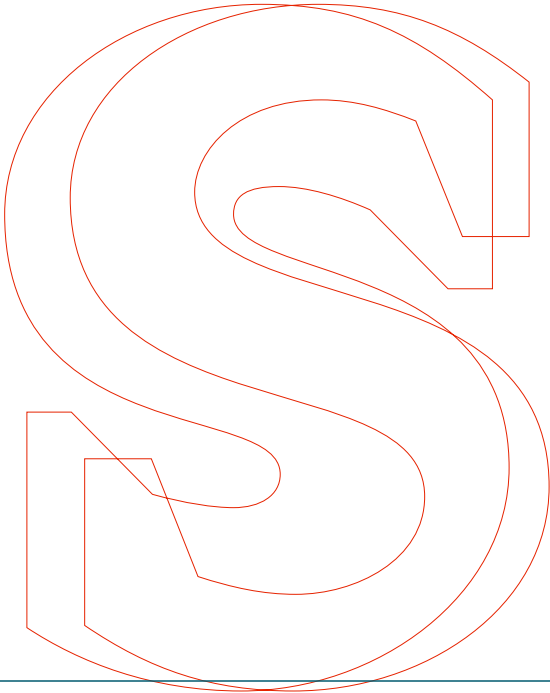
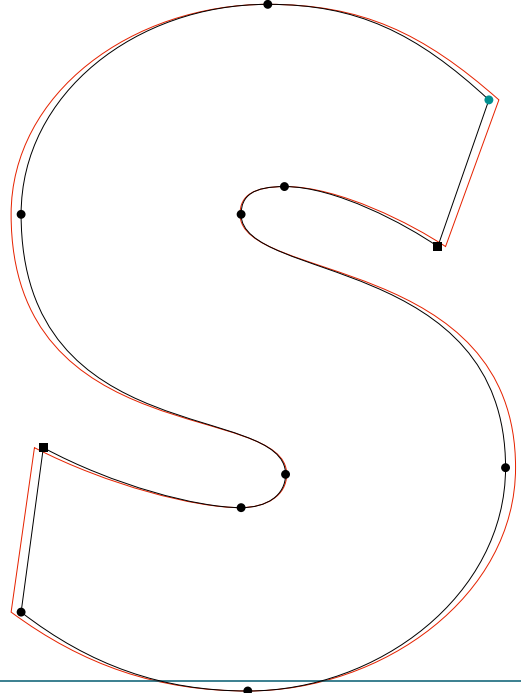
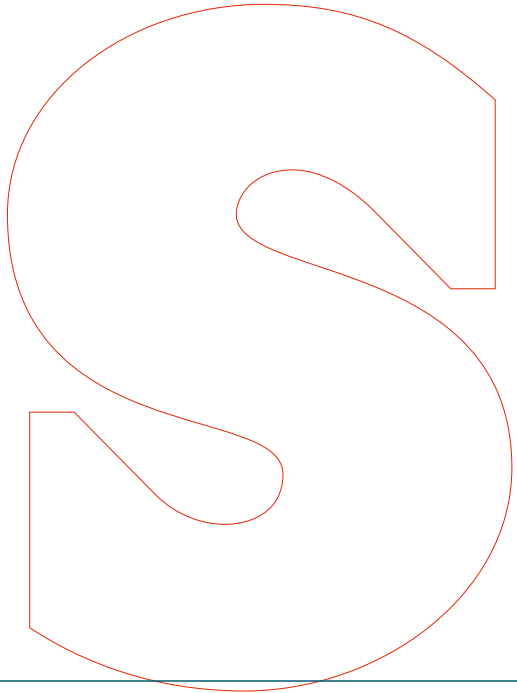

**BASE 9 & 12**

.....  
BaseTwelve SerifB | v | RoboFog Sketches | 1995 | Emigre Fonts

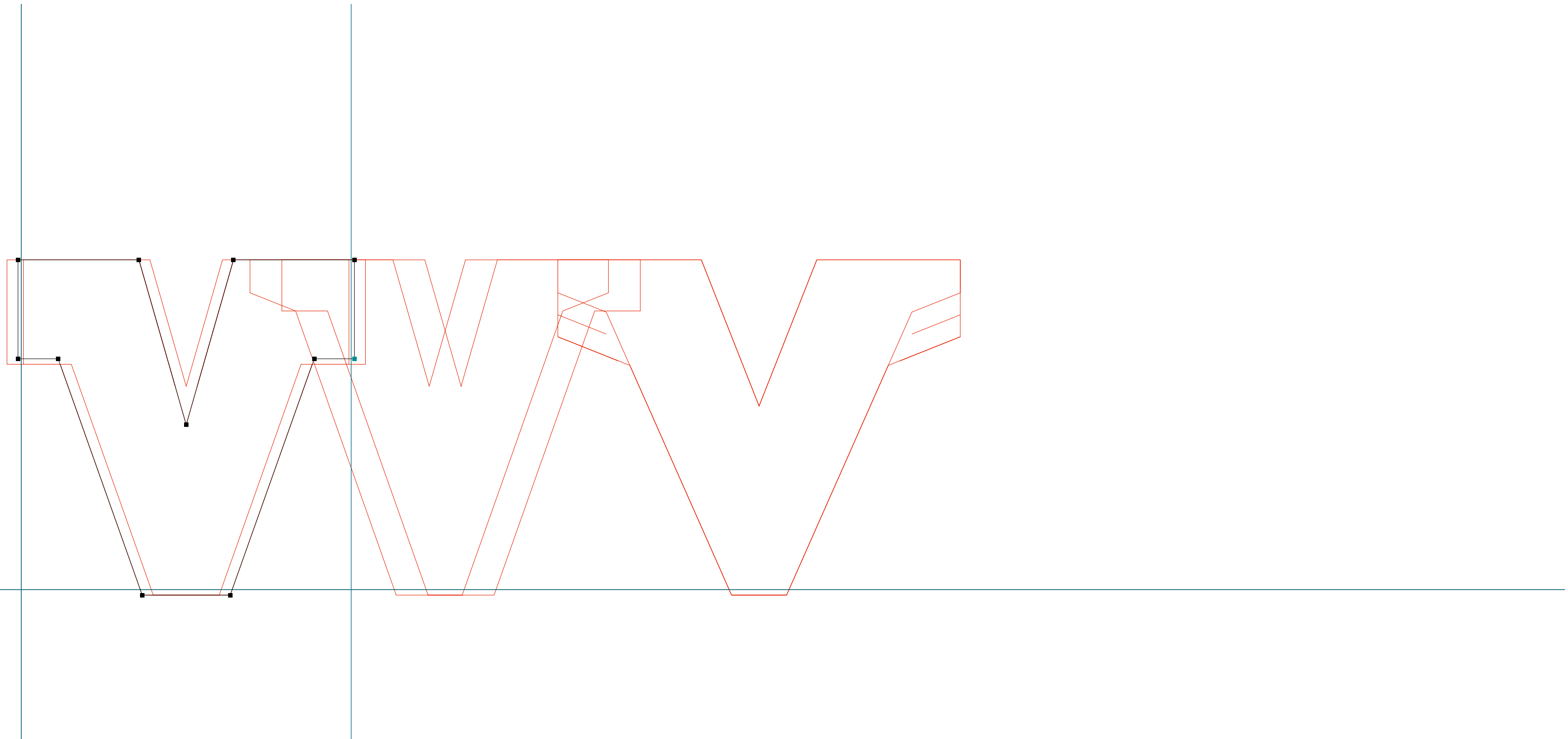

**BASE 9 & 12**

.....  
BaseTwelve SerifB | x | RoboFog Sketches | 1995 | Emigre Fonts





**BASE 9 & 12**

.....  
BaseTwelve SerifB | y | RoboFog Sketches | 1995 | Emigre Fonts

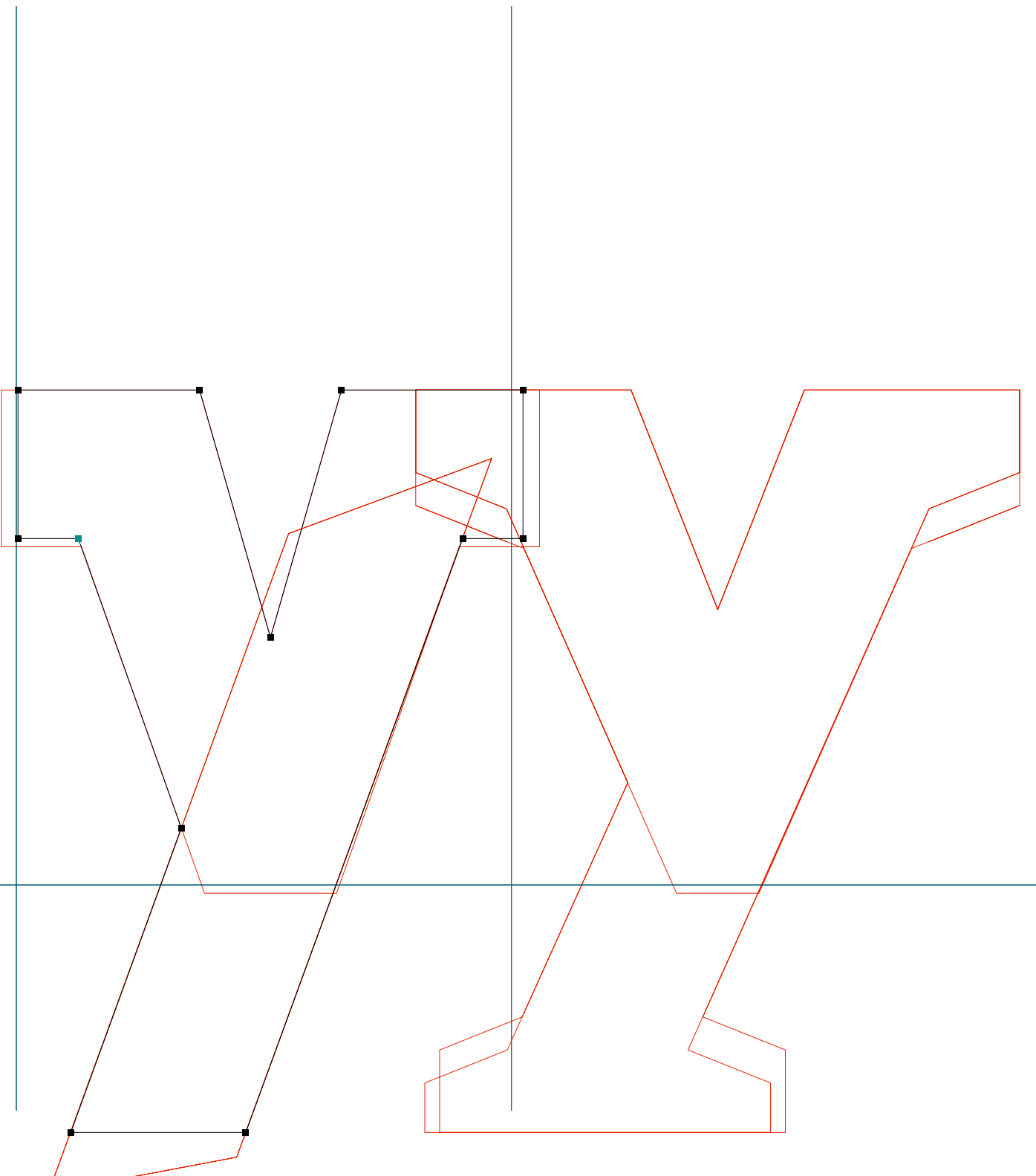

**BASE 9 & 12**

.....  
BaseTwelve SerifBI | three | RoboFog Sketches | 1995 | Emigre Fonts

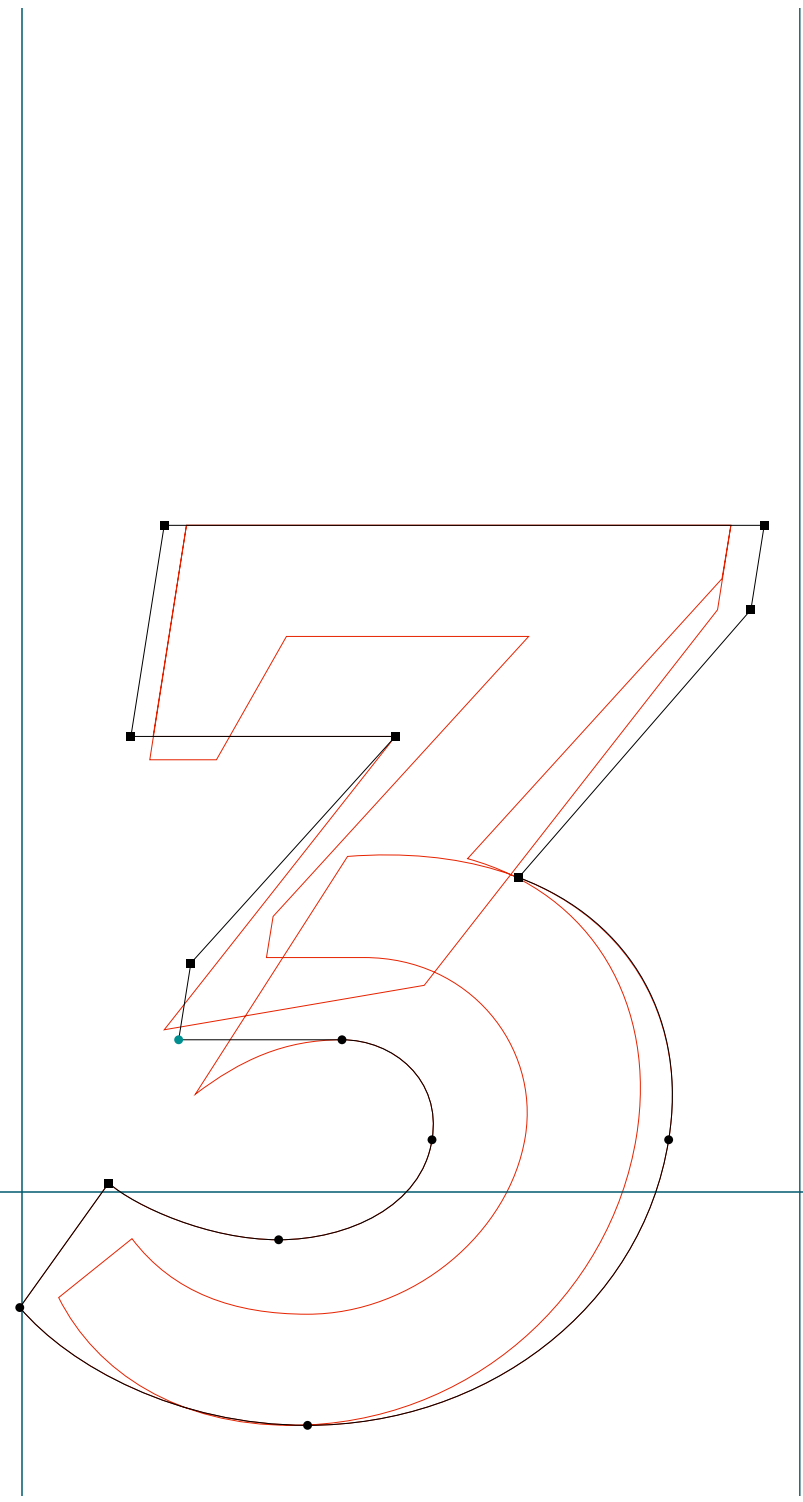

**BASE 9 & 12**

.....  
BaseTwelve SerifBI | five | RoboFog Sketches | 1995 | Emigre Fonts

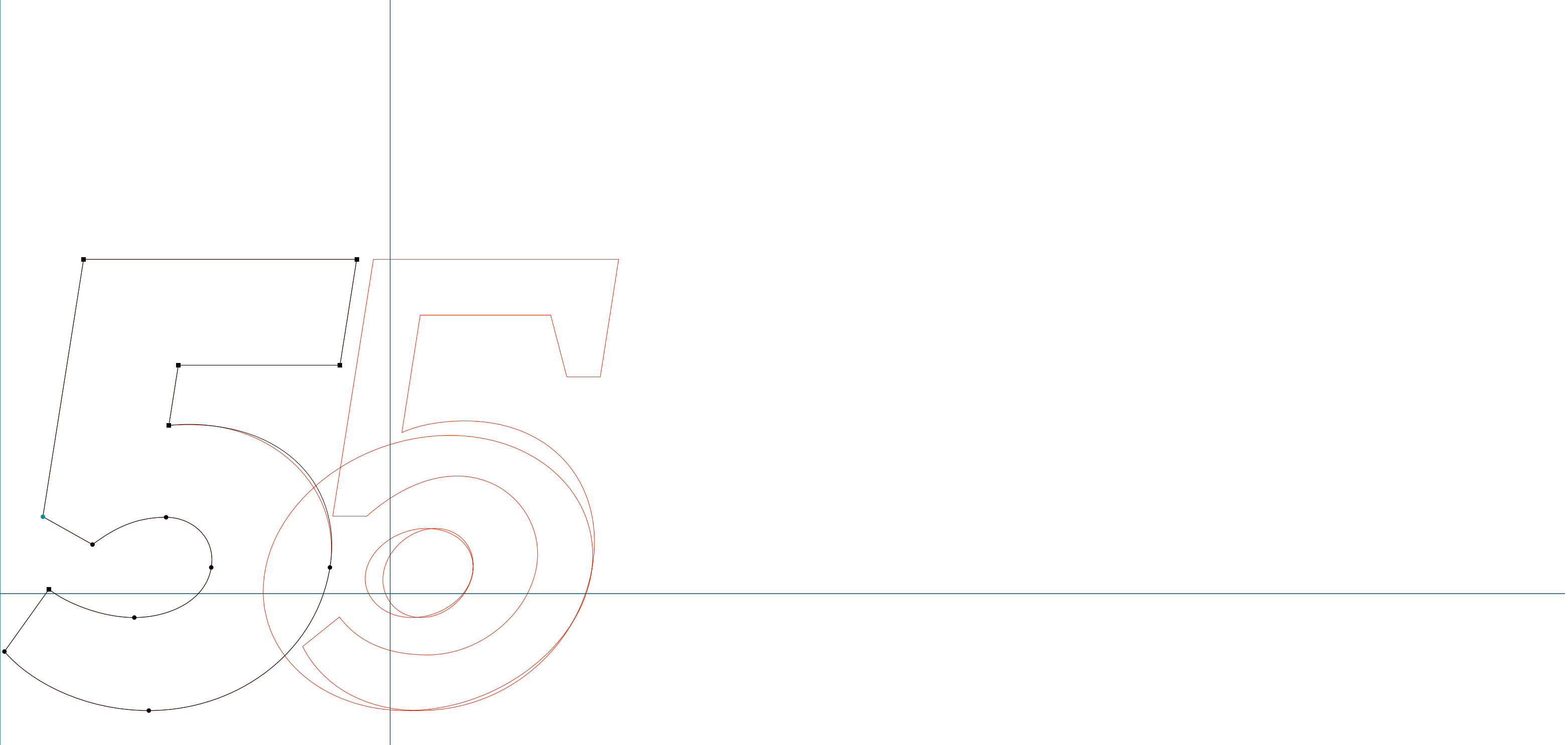

**BASE 9 & 12**

.....  
BaseTwelve SerifBI | six | RoboFog Sketches | 1995 | Emigre Fonts

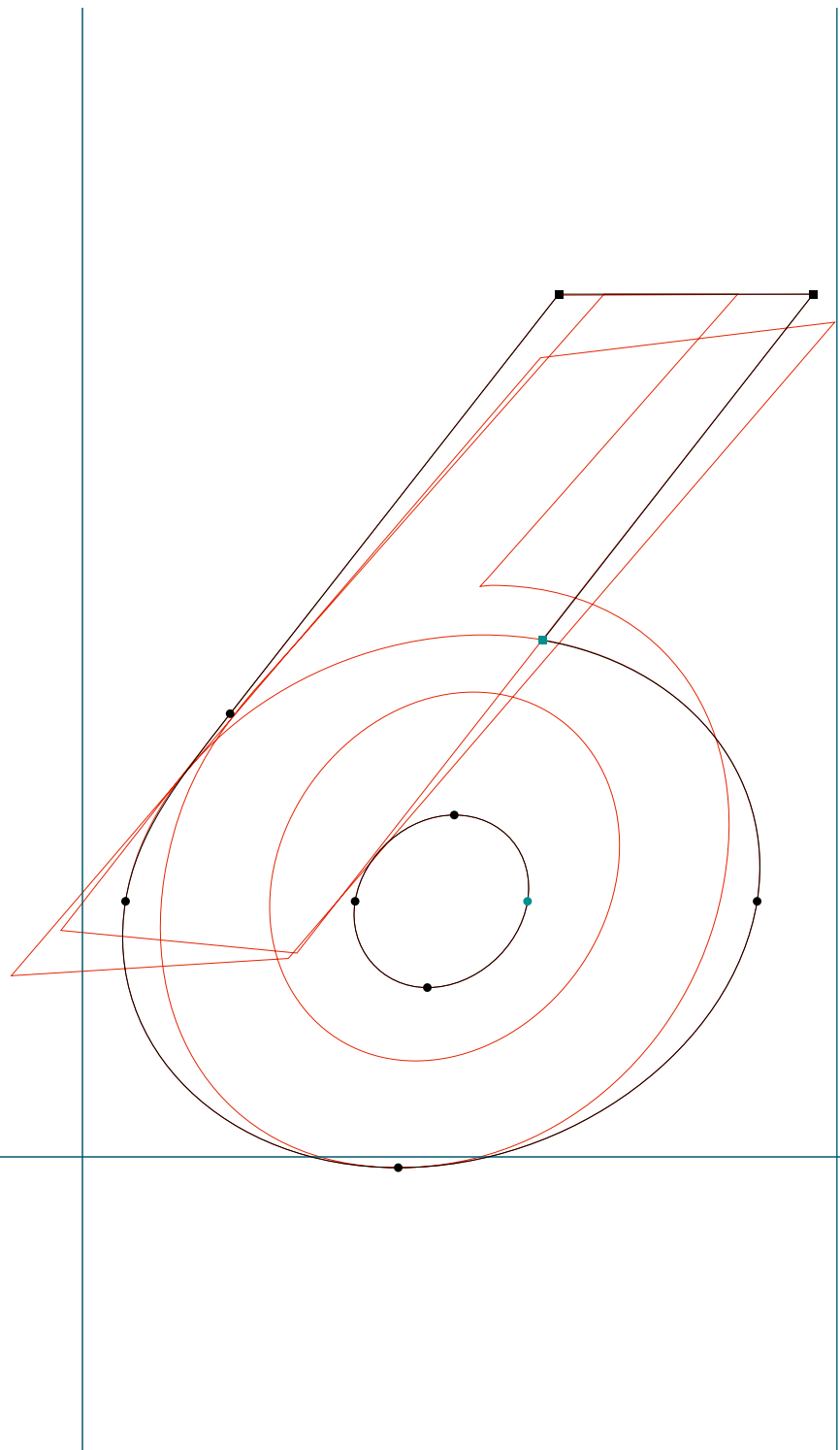

**BASE 9 & 12**

.....  
BaseTwelve SerifBI | eight | RoboFog Sketches | 1995 | Emigre Fonts

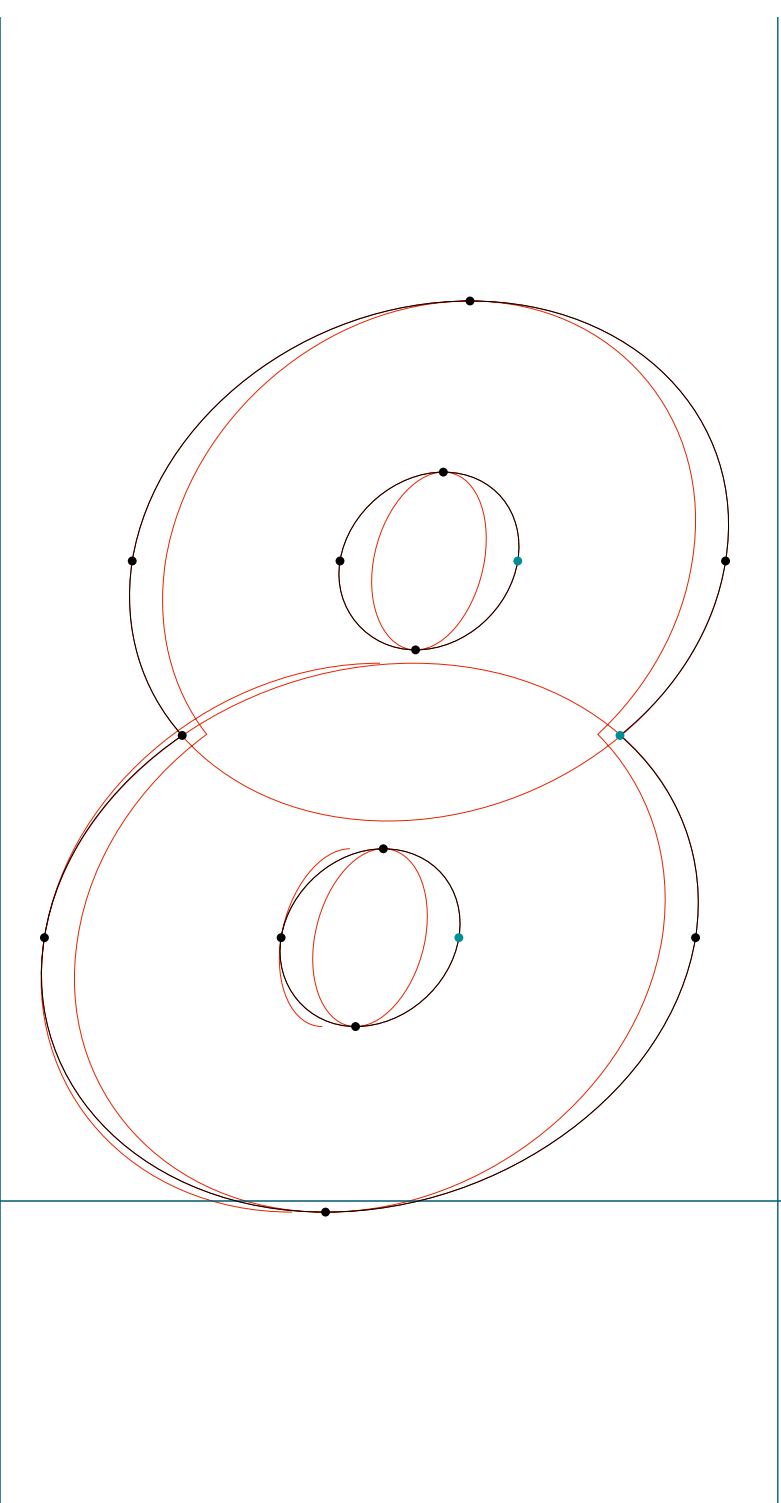

**BASE 9 & 12**

.....  
BaseTwelve SerifBI | A | RoboFog Sketches | 1995 | Emigre Fonts

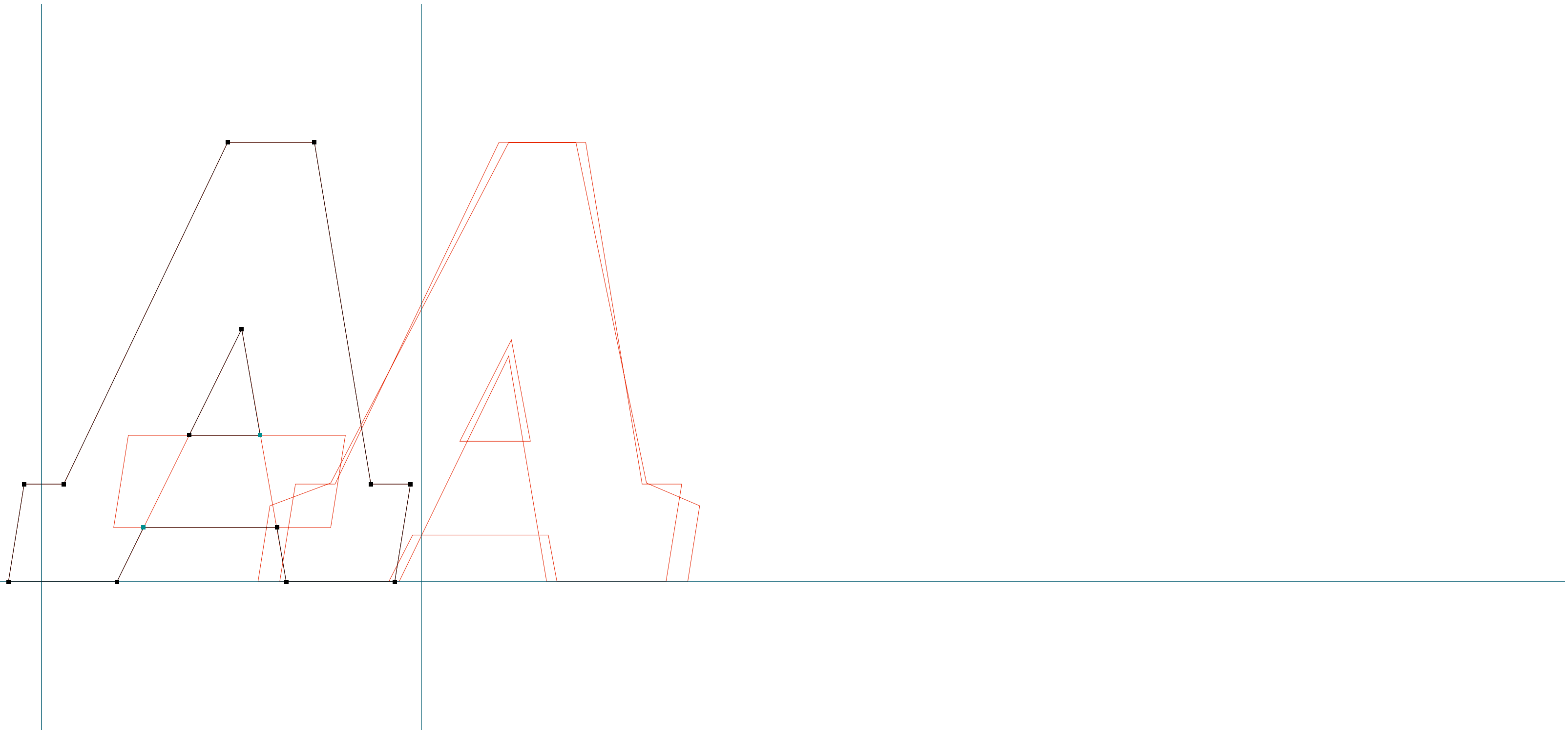

**BASE 9 & 12**

.....  
BaseTwelve SerifBI | B | RoboFog Sketches | 1995 | Emigre Fonts

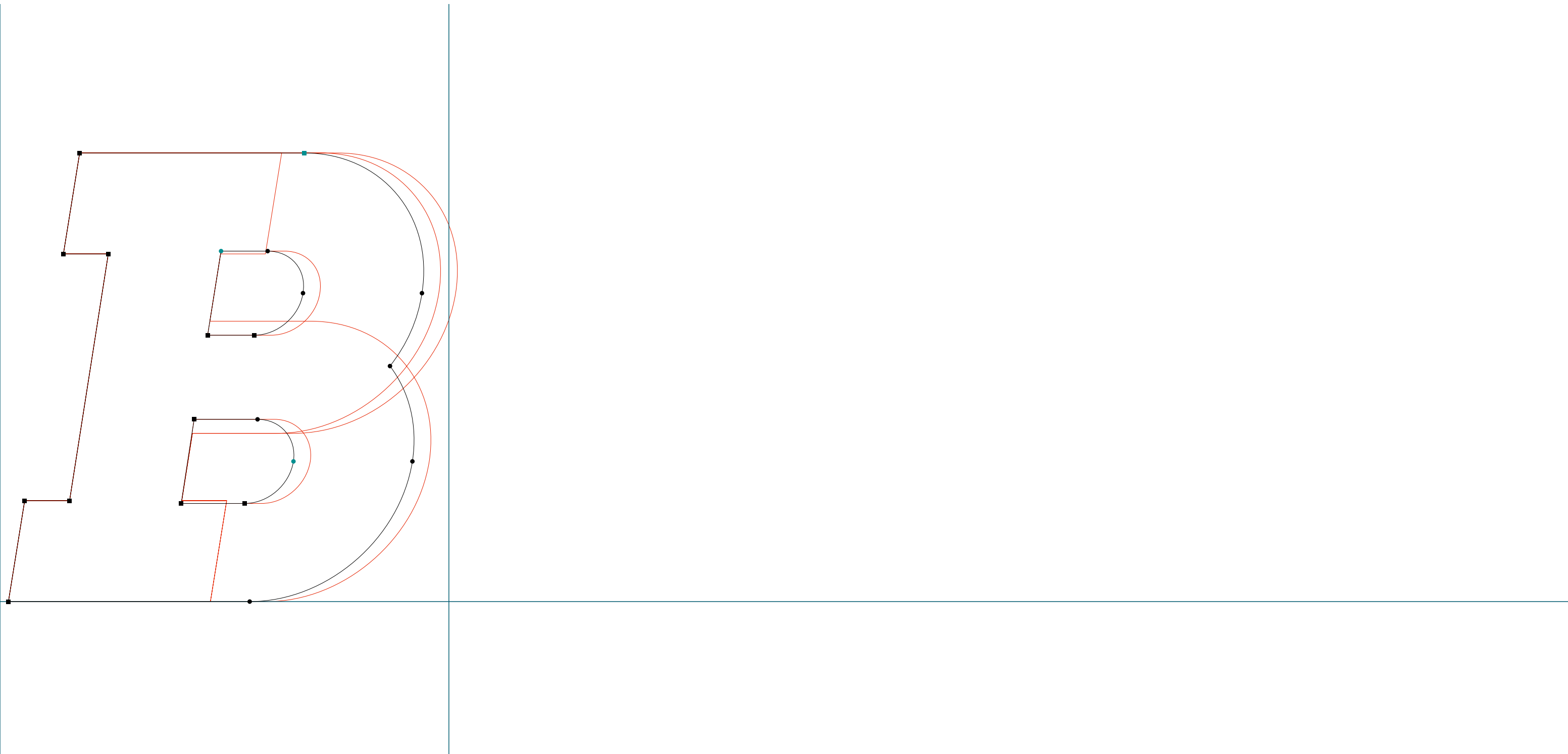

**BASE 9 & 12**

.....  
BaseTwelve SerifBI | C | RoboFog Sketches | 1995 | Emigre Fonts

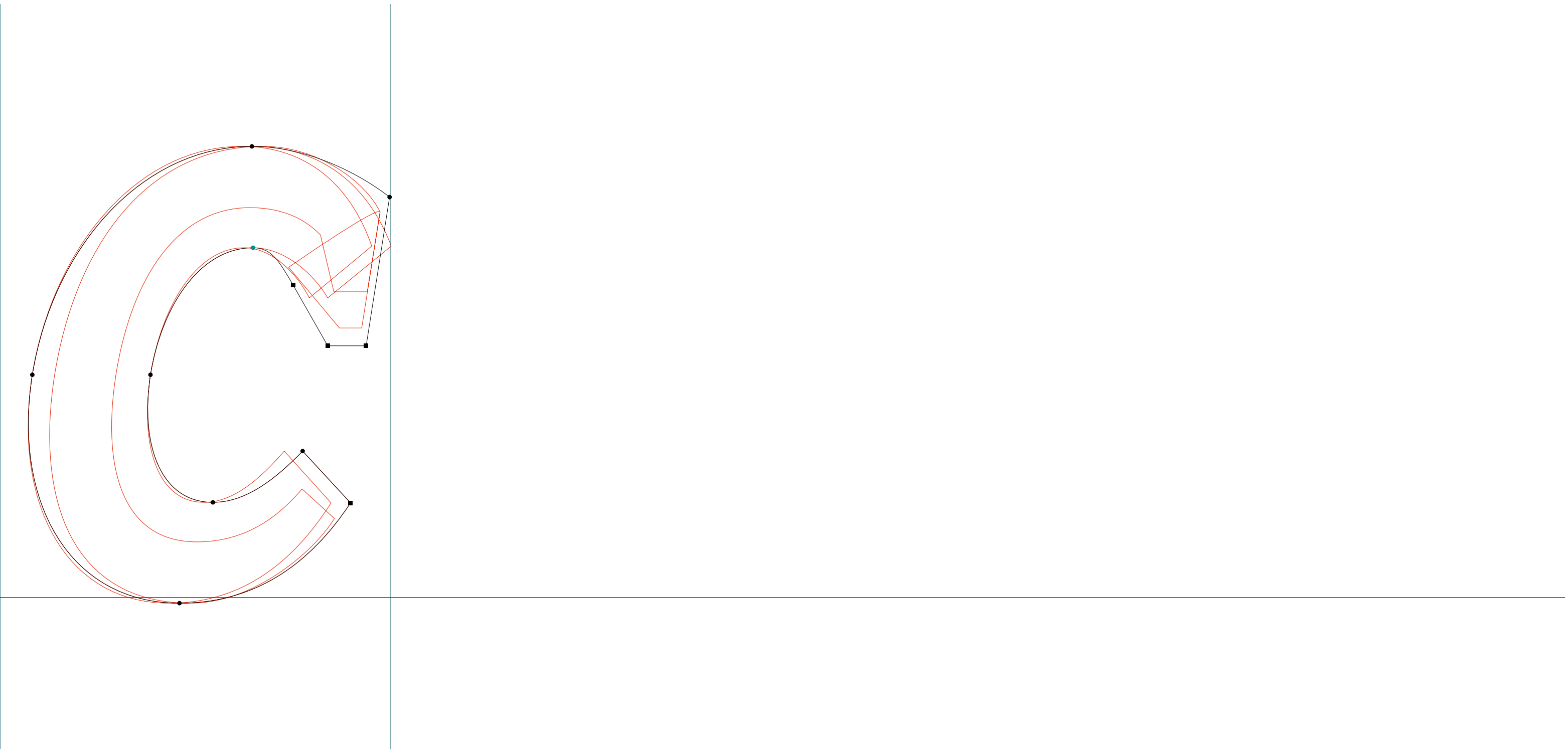



**BASE 9 & 12**

.....  
BaseTwelve SerifBI | H | RoboFog Sketches | 1995 | Emigre Fonts

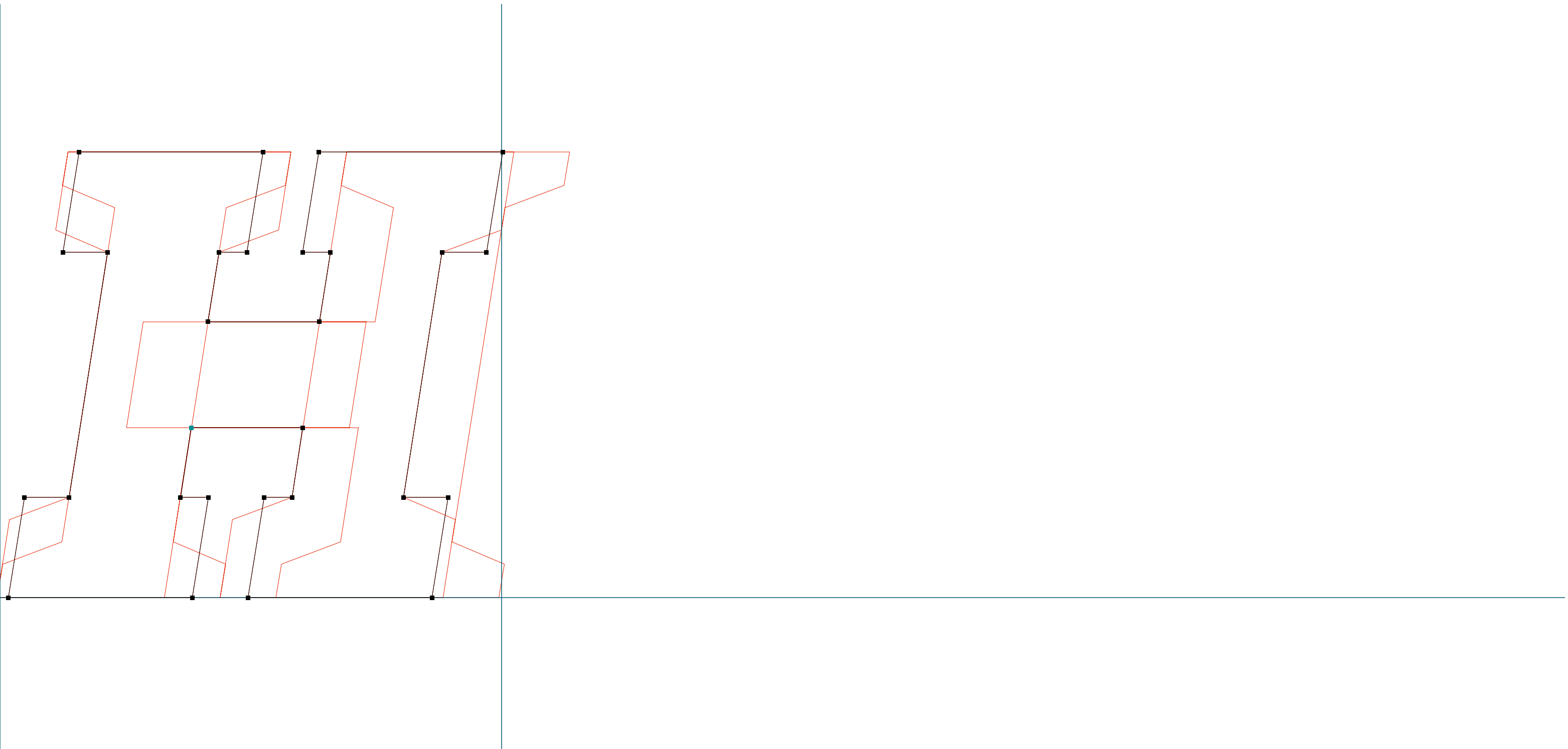

**BASE 9 & 12**

.....  
BaseTwelve SerifBI | I | RoboFog Sketches | 1995 | Emigre Fonts

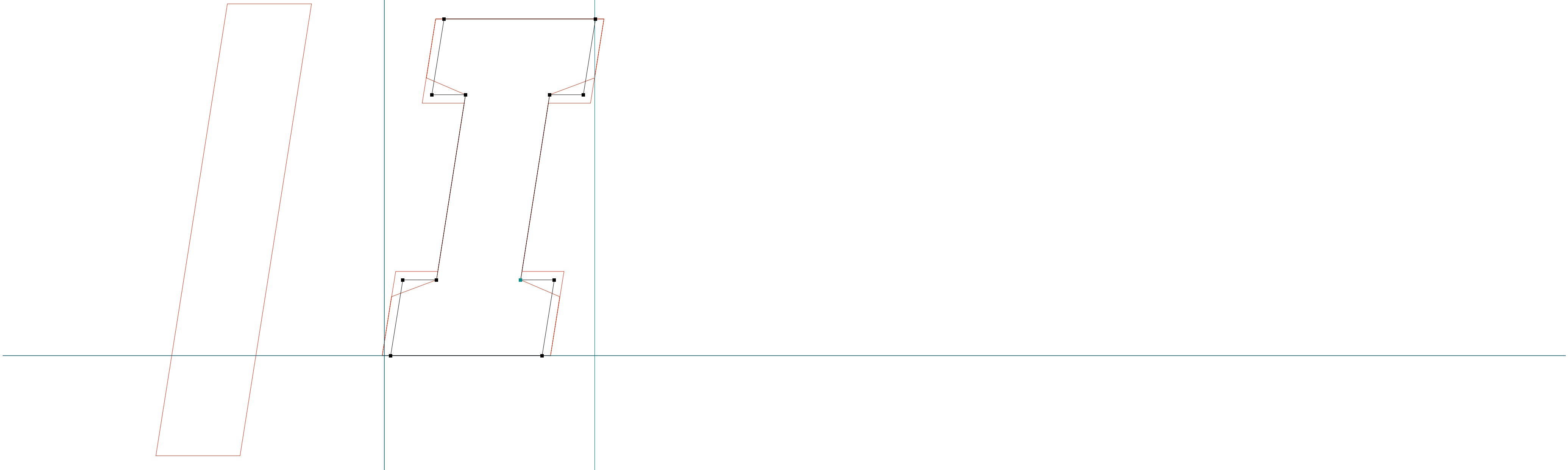

**BASE 9 & 12**

.....  
BaseTwelve SerifBI | K | RoboFog Sketches | 1995 | Emigre Fonts

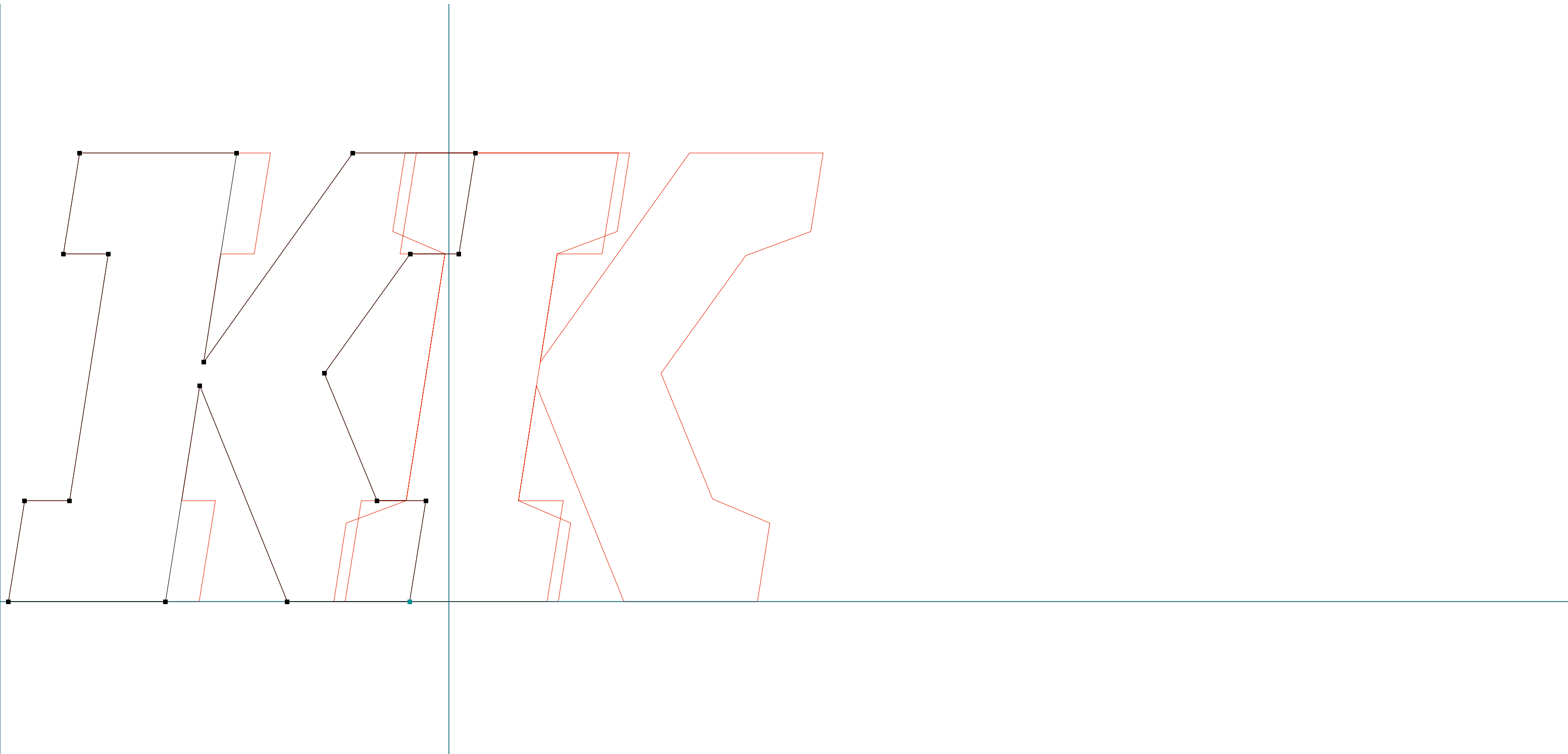

**BASE 9 & 12**

.....  
BaseTwelve SerifBI | T | RoboFog Sketches | 1995 | Emigre Fonts

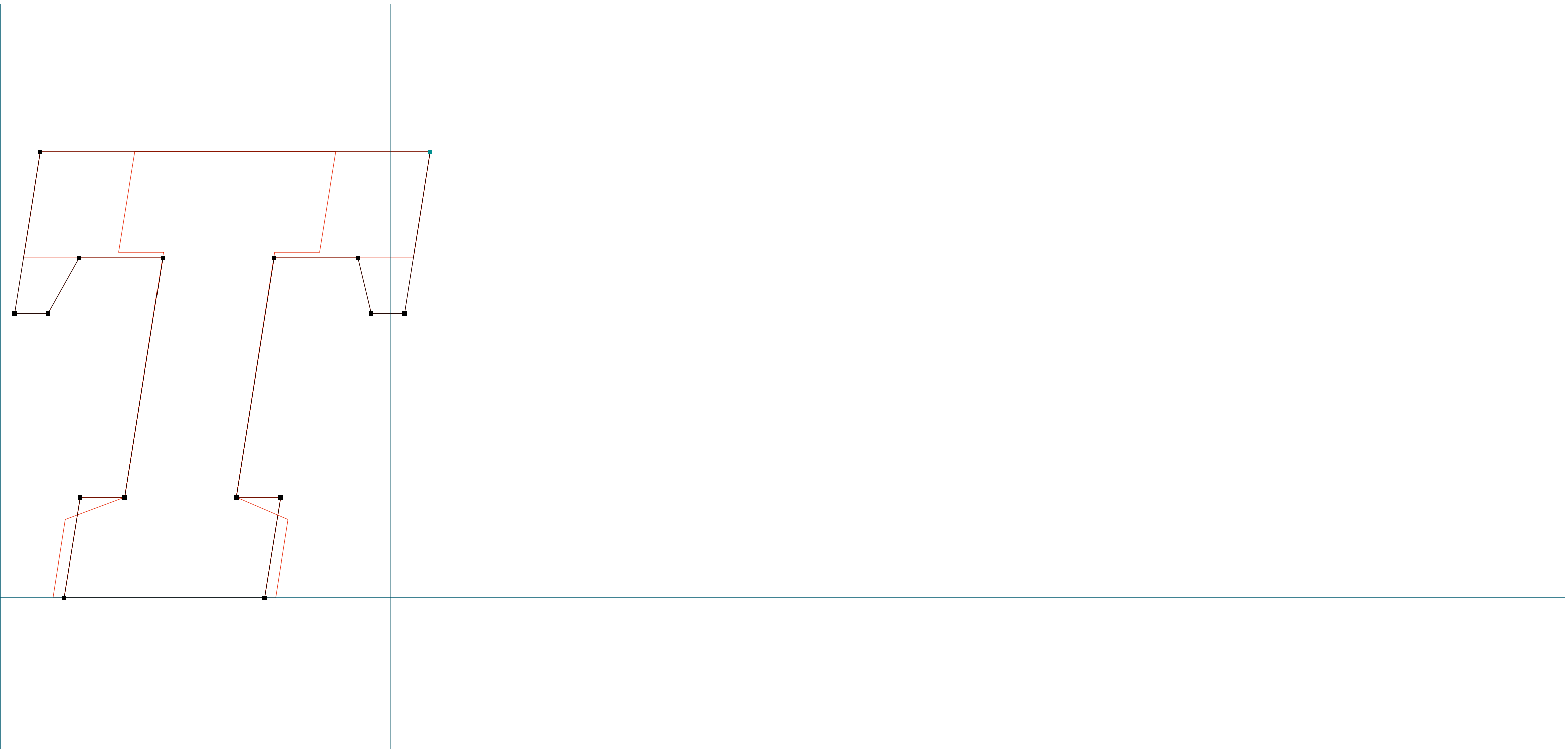

**BASE 9 & 12**

.....  
BaseTwelve SerifBI | W | RoboFog Sketches | 1995 | Emigre Fonts

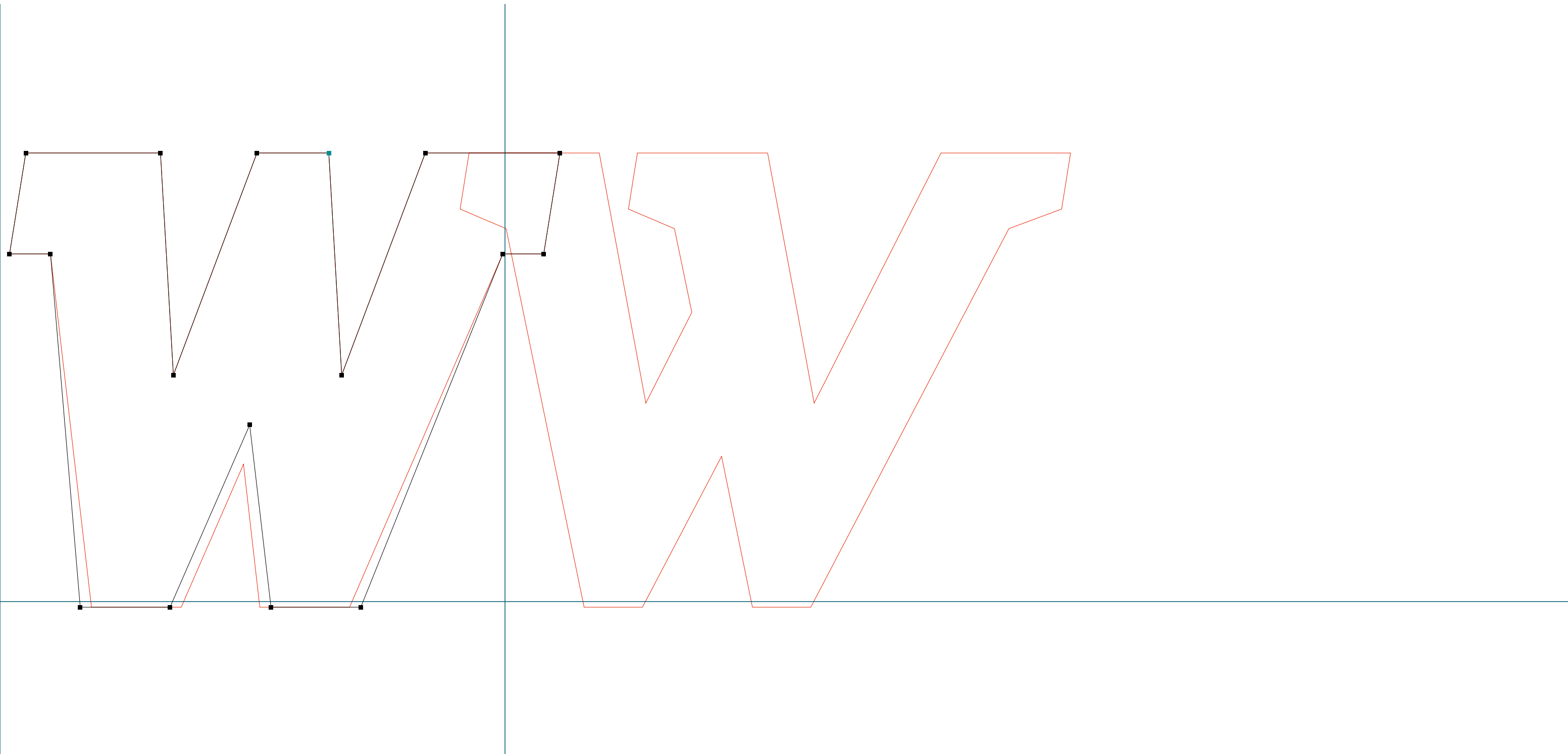

**BASE 9 & 12**

.....  
BaseTwelve SerifBI | a | RoboFog Sketches | 1995 | Emigre Fonts

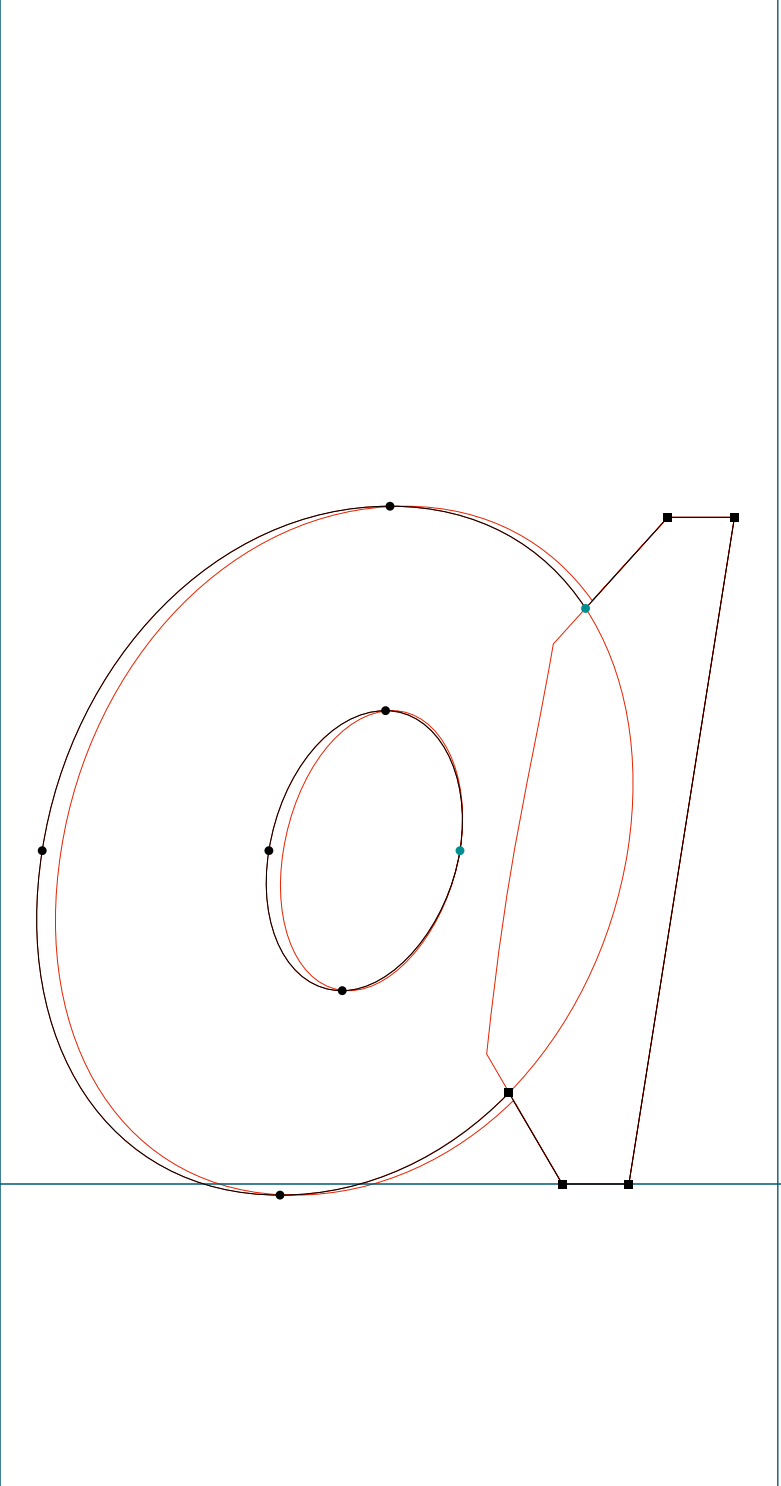

**BASE 9 & 12**

BaseTwelve SerifBI | c | RoboFog Sketches | 1995 | Emigre Fonts

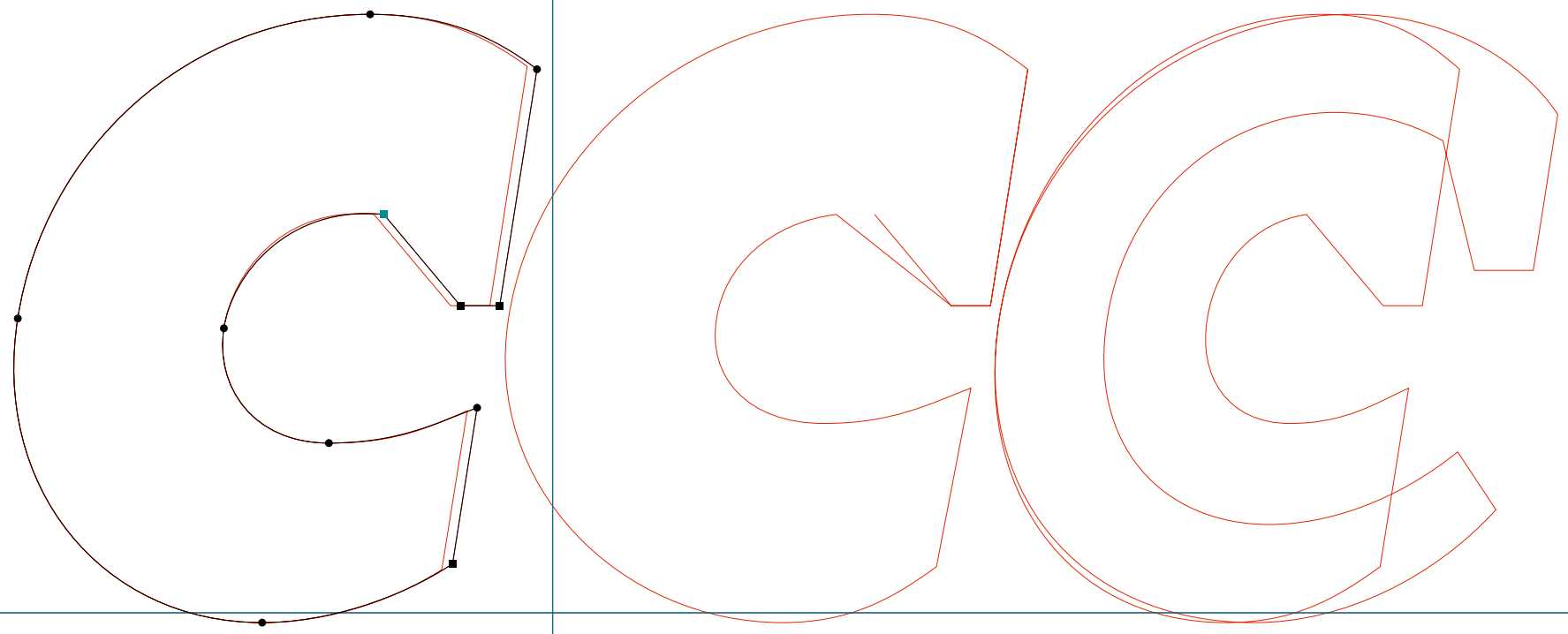

**BASE 9 & 12**

.....  
BaseTwelve SerifBI | g | RoboFog Sketches | 1995 | Emigre Fonts

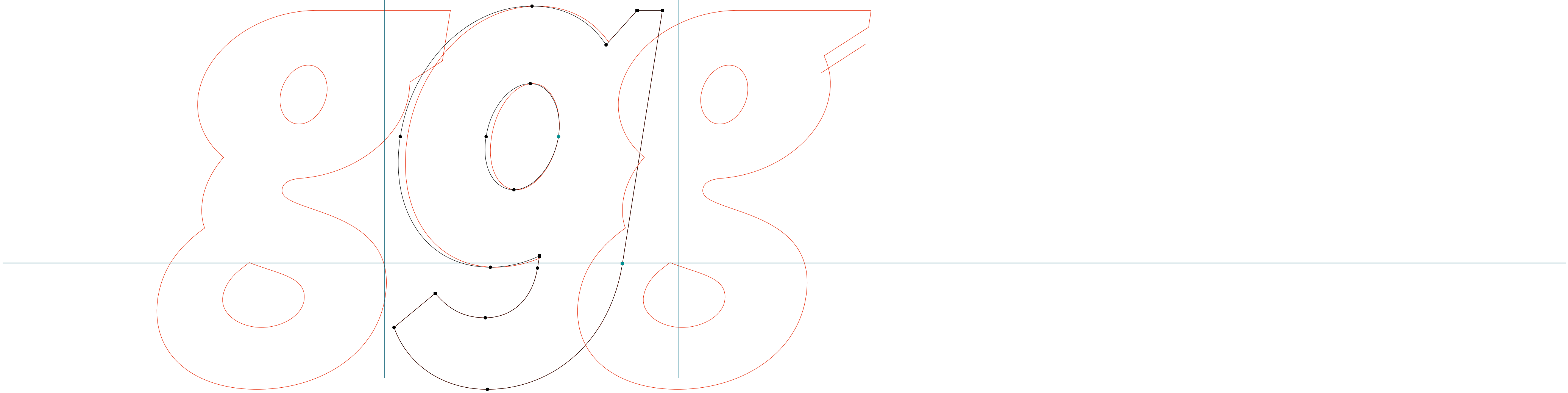



**BASE 9 & 12**

.....  
BaseTwelve SerifBI | h | RoboFog Sketches | 1995 | Emigre Fonts

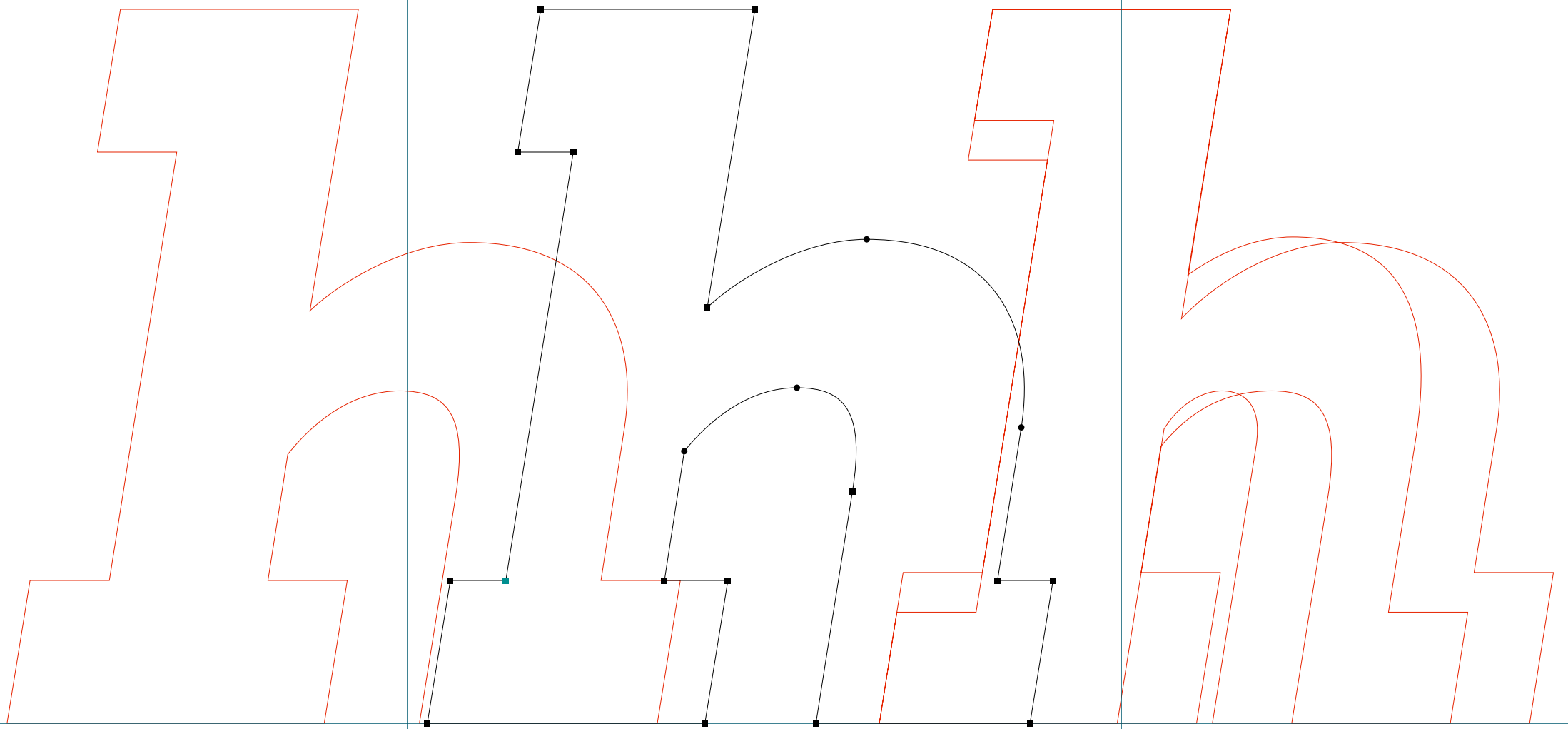

**BASE 9 & 12**

.....  
BaseTwelve SerifBI | i | RoboFog Sketches | 1995 | Emigre Fonts

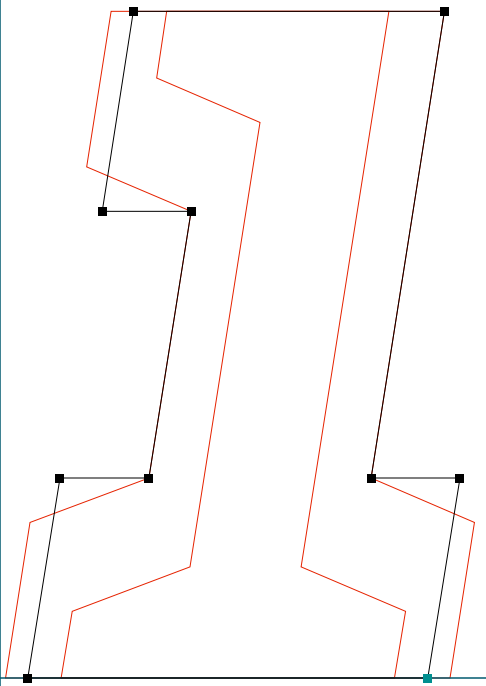
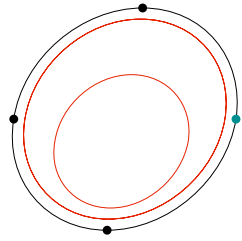

**BASE 9 & 12**

BaseTwelve SerifBI | m | RoboFog Sketches | 1995 | Emigre Fonts

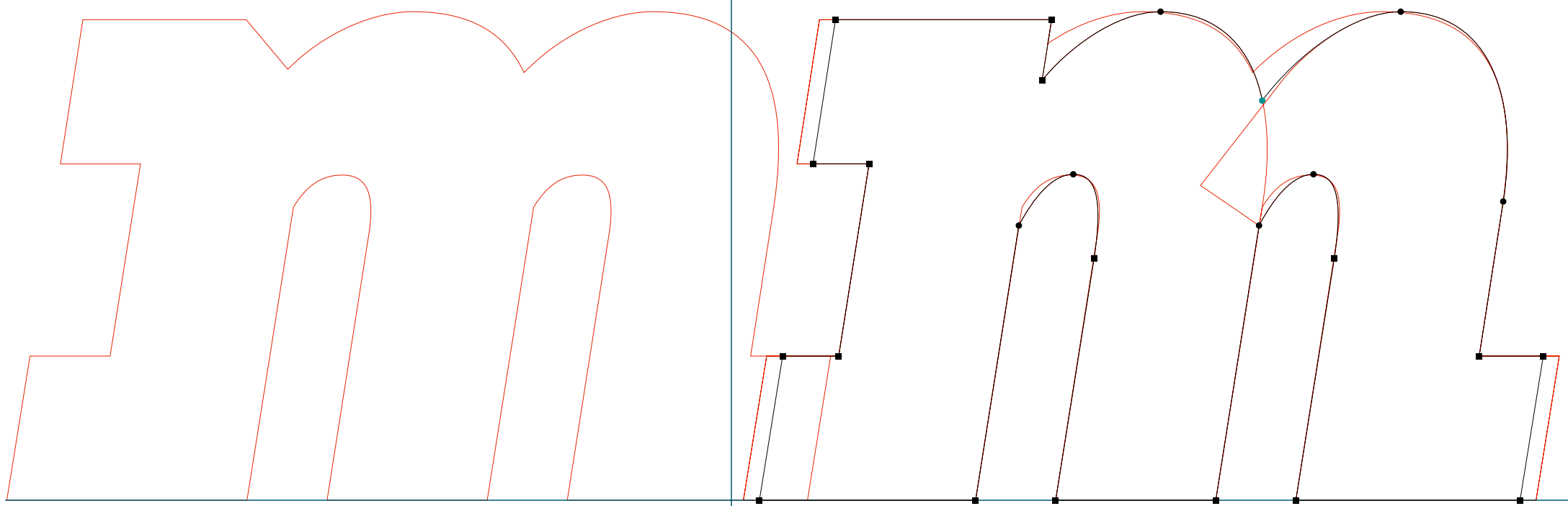

**BASE 9 & 12**

.....  
BaseTwelve SerifBI | n | RoboFog Sketches | 1995 | Emigre Fonts

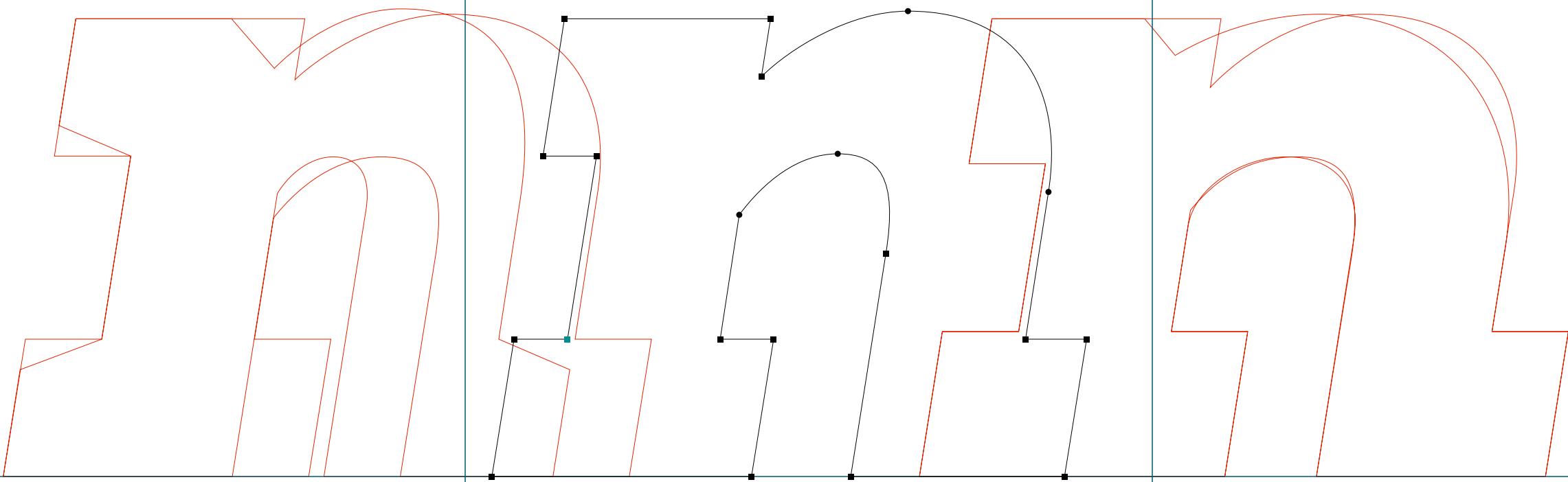

**BASE 9 & 12**

BaseTwelve SerifBI | r | RoboFog Sketches | 1995 | Emigre Fonts

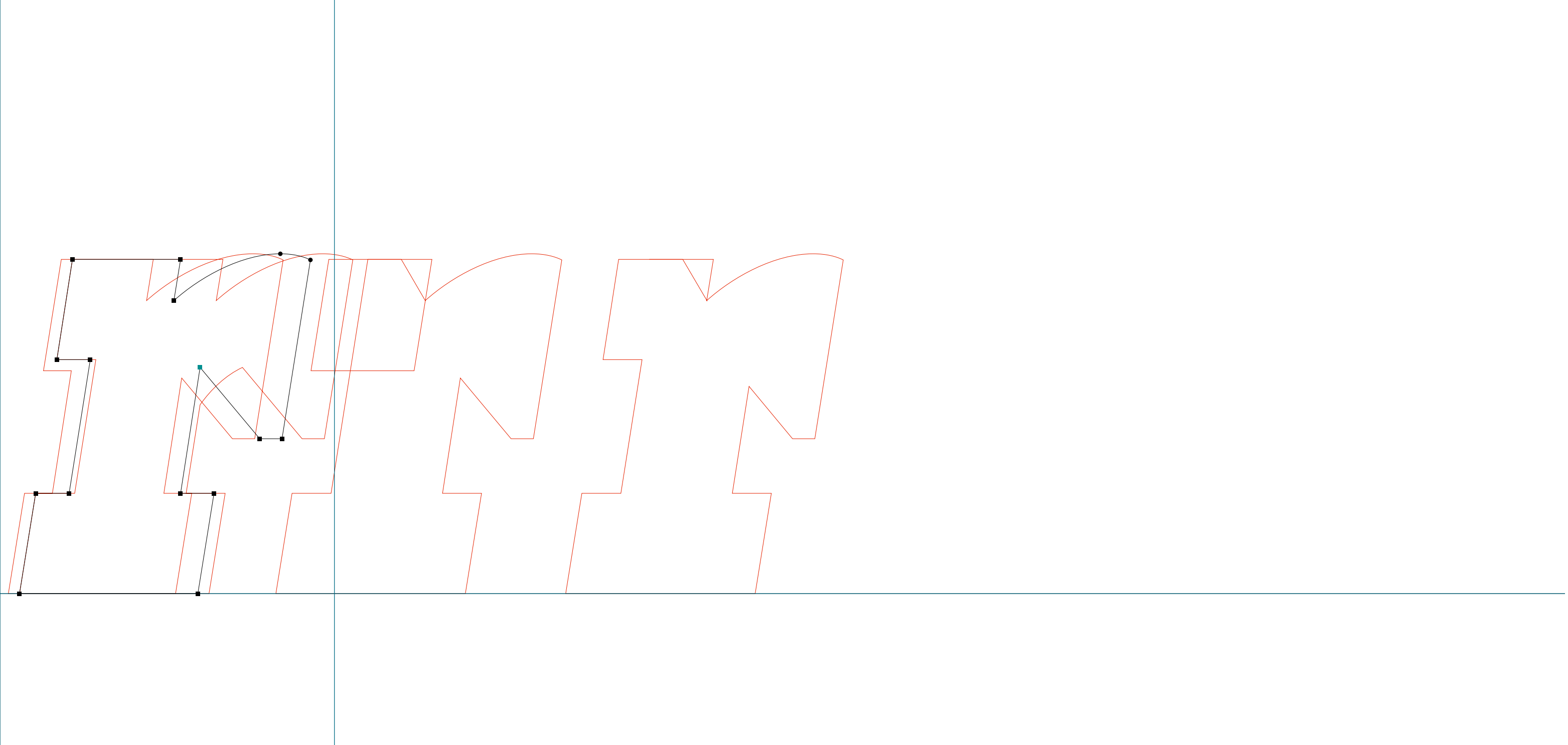

**BASE 9 & 12**

.....  
BaseTwelve SerifBI | s | RoboFog Sketches | 1995 | Emigre Fonts

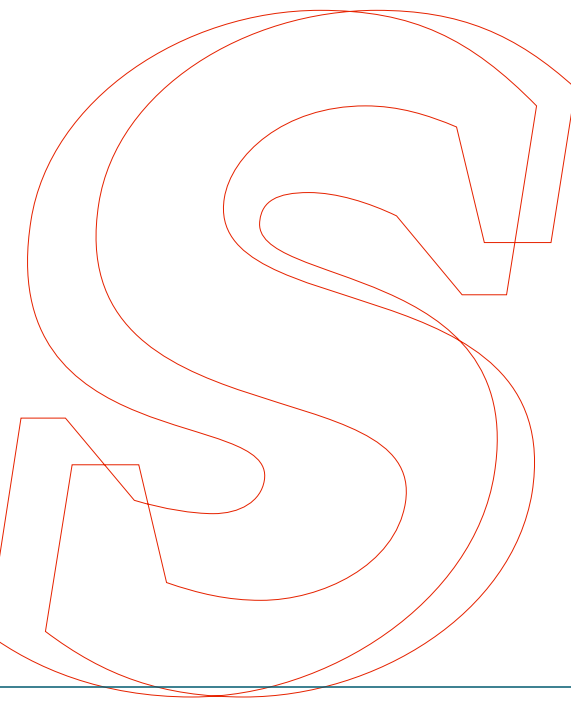
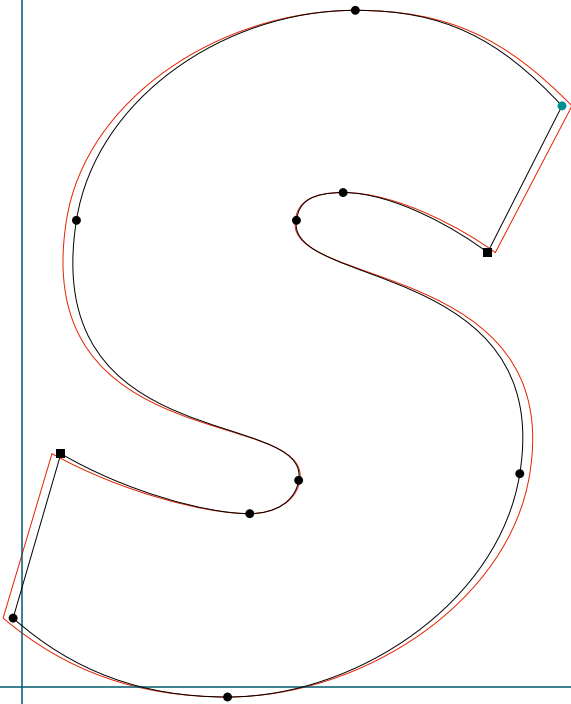

**BASE 9 & 12**

.....  
BaseTwelve SerifBI | v | RoboFog Sketches | 1995 | Emigre Fonts



**BASE 9 & 12**

.....  
BaseTwelve SerifBI | x | RoboFog Sketches | 1995 | Emigre Fonts

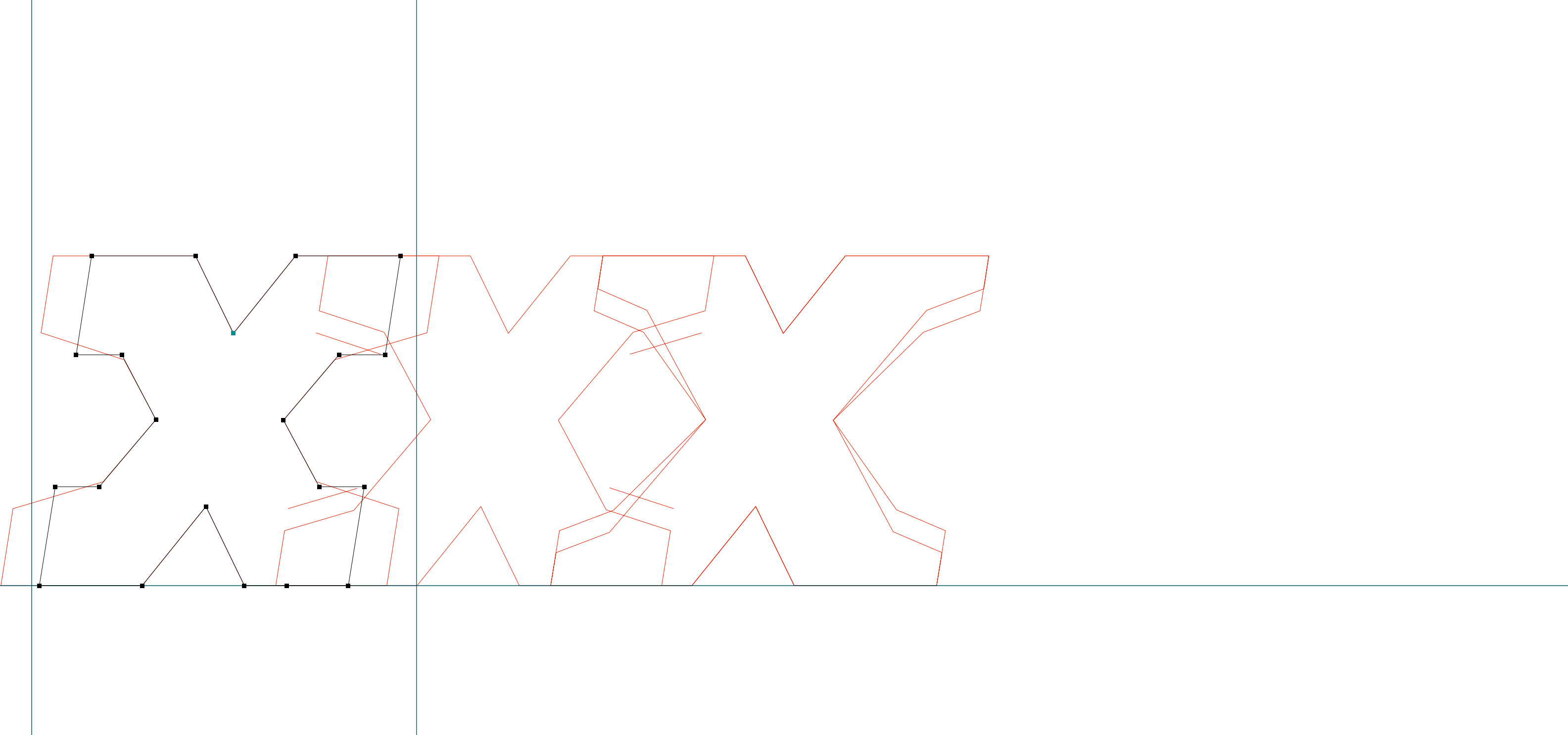



**BASE 9 & 12**

.....  
BaseTwelve SerifBI | y | RoboFog Sketches | 1995 | Emigre Fonts



**BASE 9 & 12**

.....  
BaseTwelve SerifSCB | three | RoboFog Sketches | 1995 | Emigre Fonts

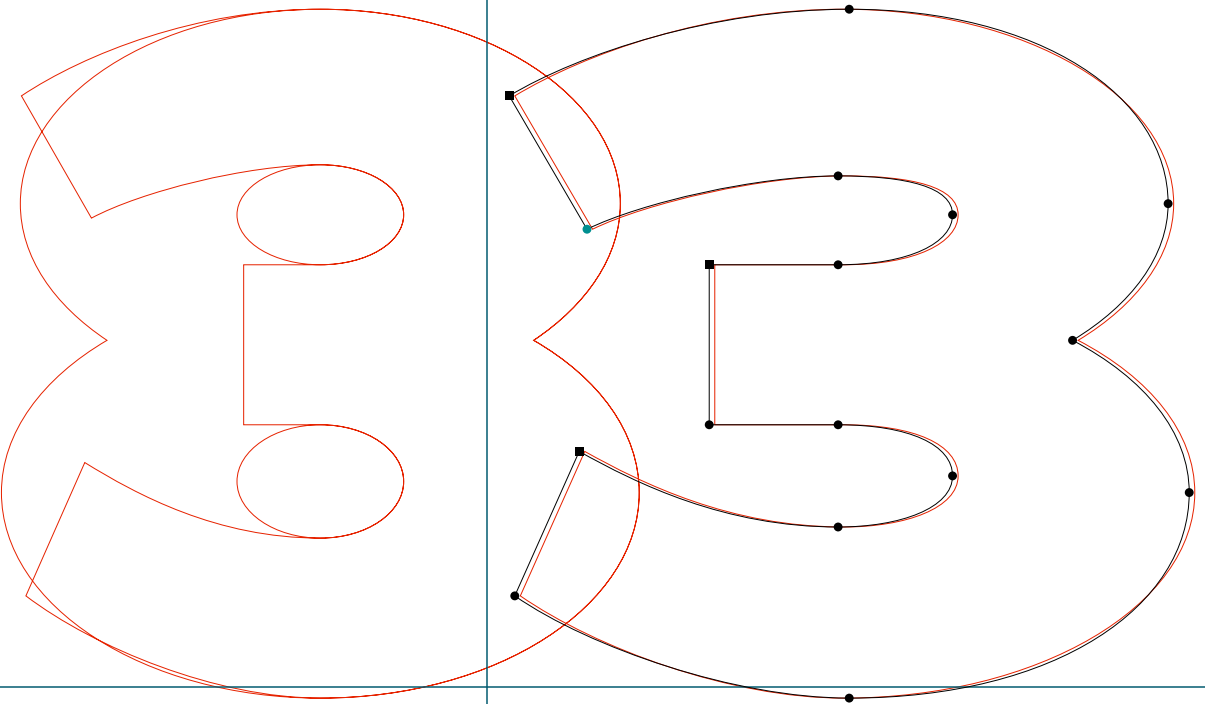

**BASE 9 & 12**

.....  
BaseTwelve SerifSCB | six | RoboFog Sketches | 1995 | Emigre Fonts

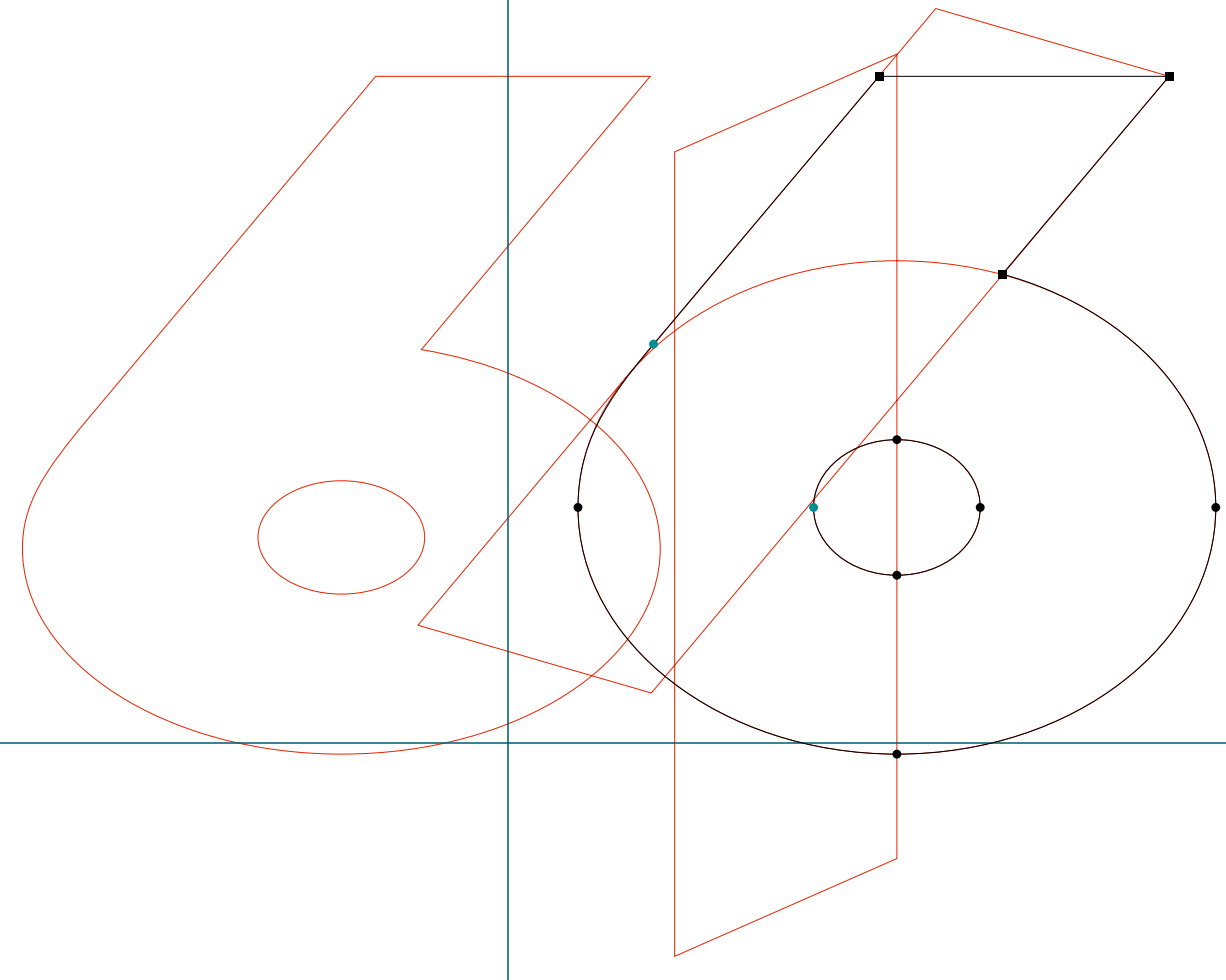

**BASE 9 & 12**

.....  
BaseTwelve SerifSCB | A | RoboFog Sketches | 1995 | Emigre Fonts



**BASE 9 & 12**

.....  
BaseTwelve SerifSCB | B | RoboFog Sketches | 1995 | Emigre Fonts

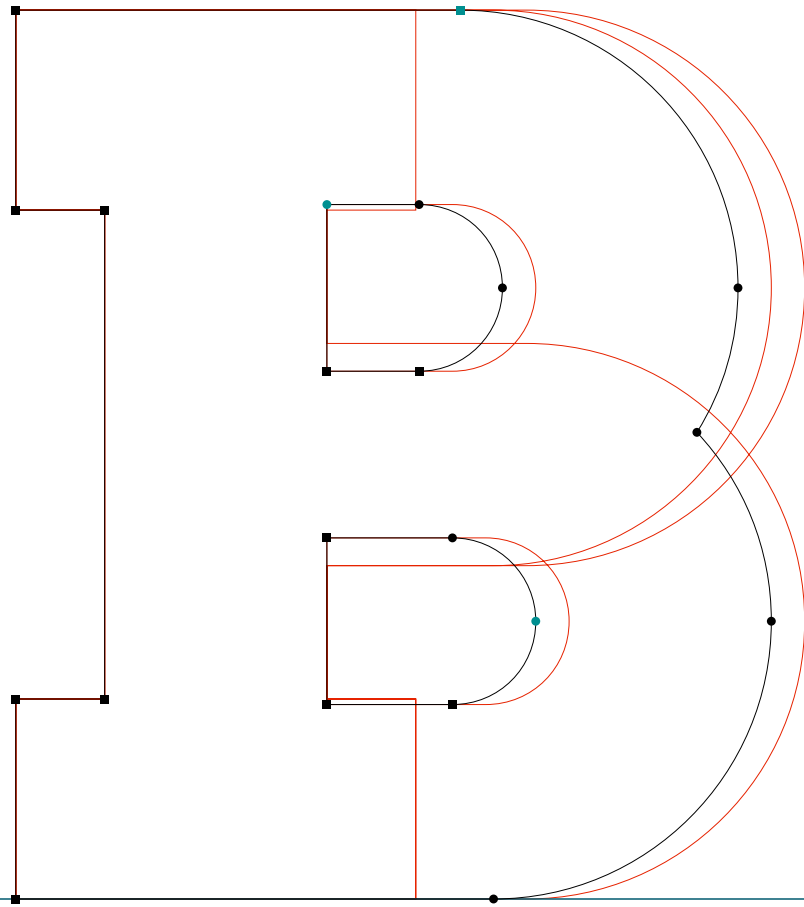

**BASE 9 & 12**

.....  
BaseTwelve SerifSCB | C | RoboFog Sketches | 1995 | Emigre Fonts

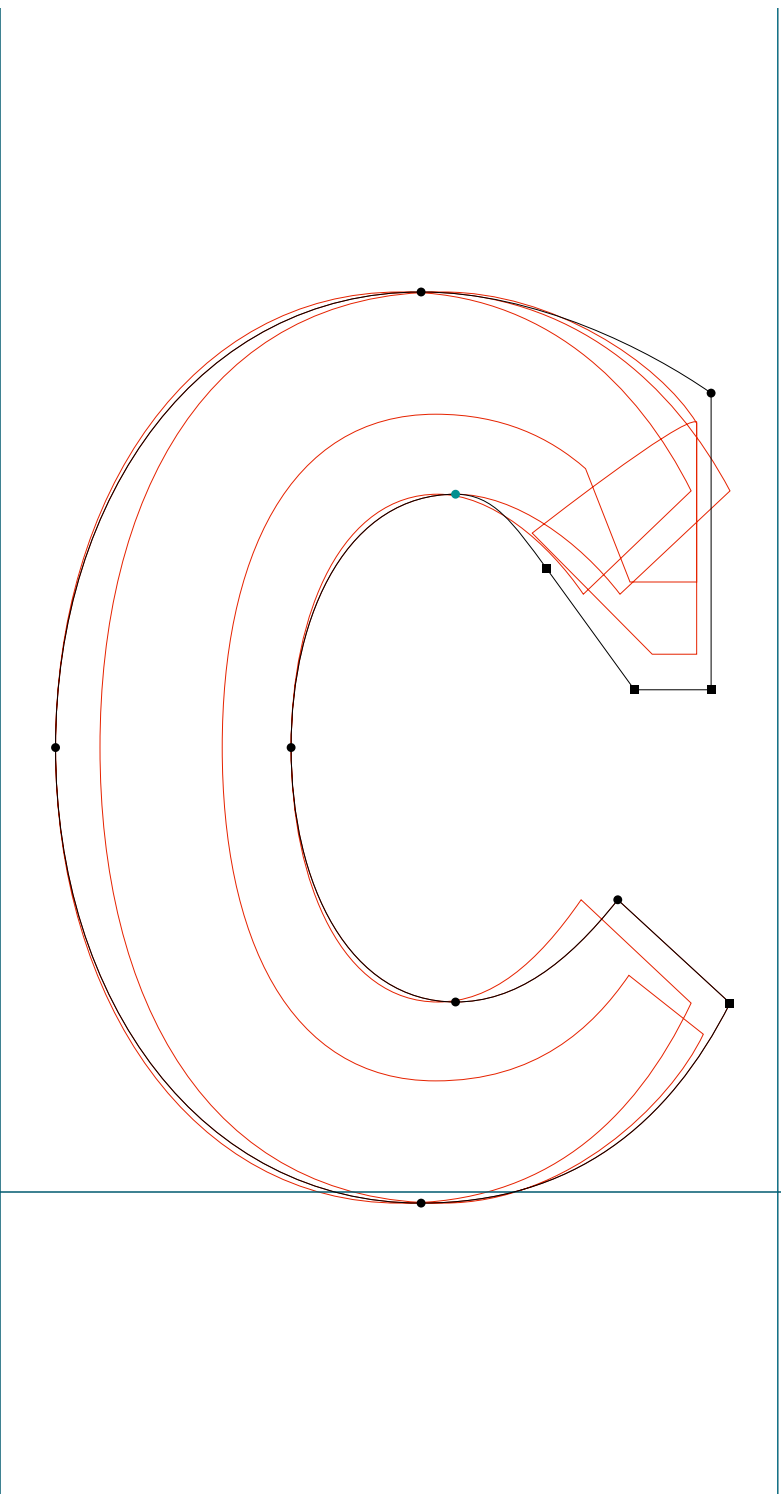

**BASE 9 & 12**

.....  
BaseTwelve SerifSCB | H | RoboFog Sketches | 1995 | Emigre Fonts

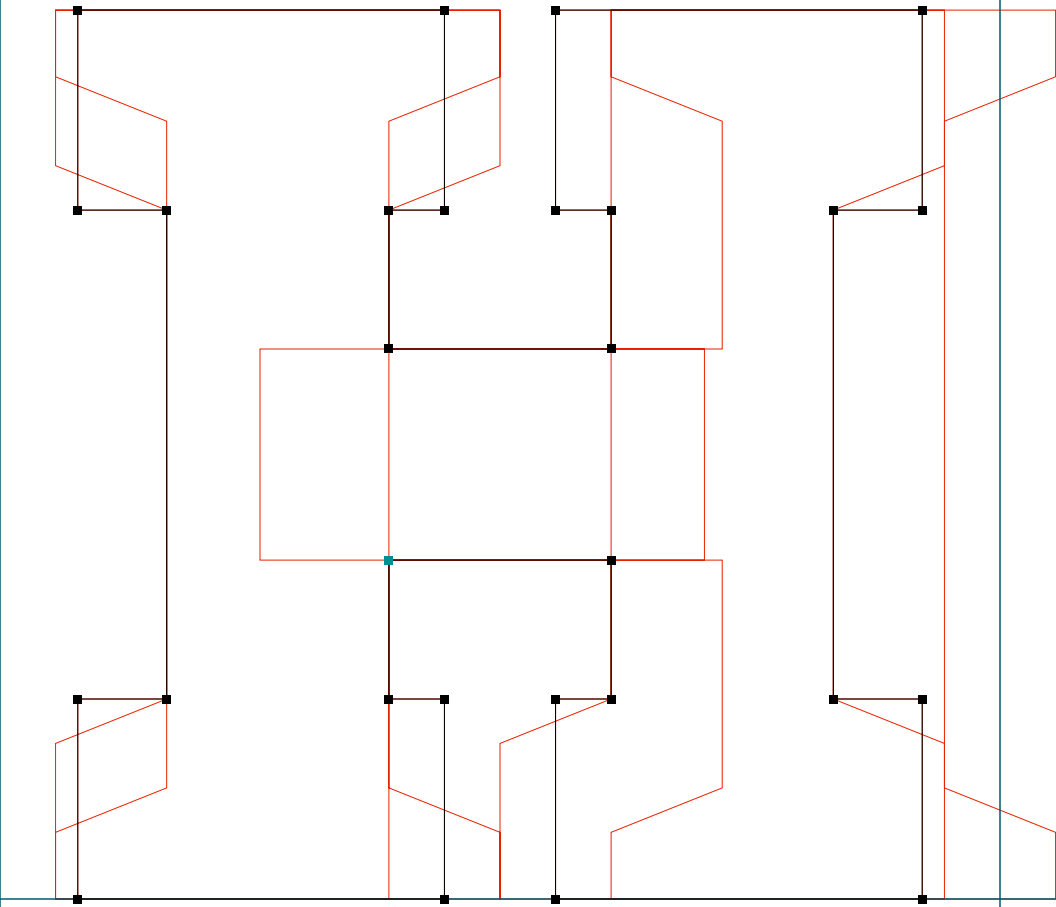

**BASE 9 & 12**

BaseTwelve SerifSCB | I | RoboFog Sketches | 1995 | Emigre Fonts

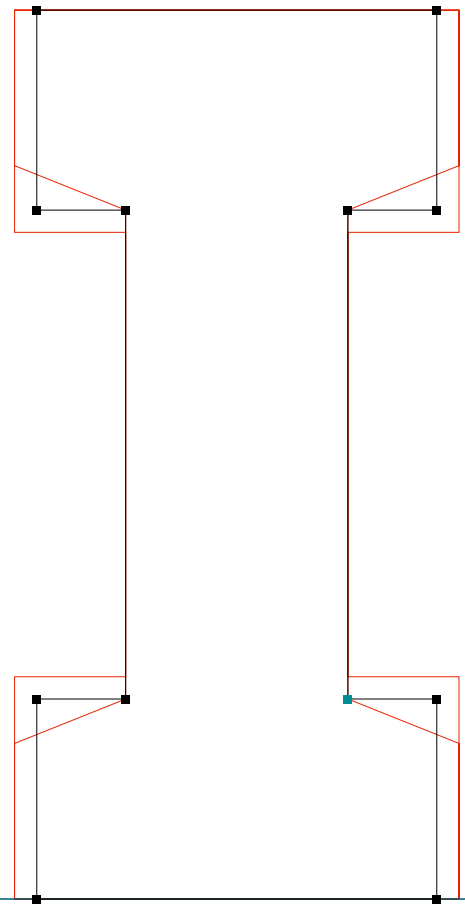
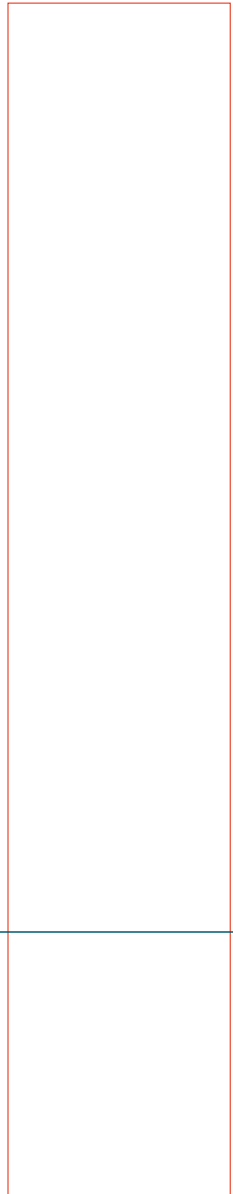



**BASE 9 & 12**

.....  
BaseTwelve SerifSCB | K | RoboFog Sketches | 1995 | Emigre Fonts

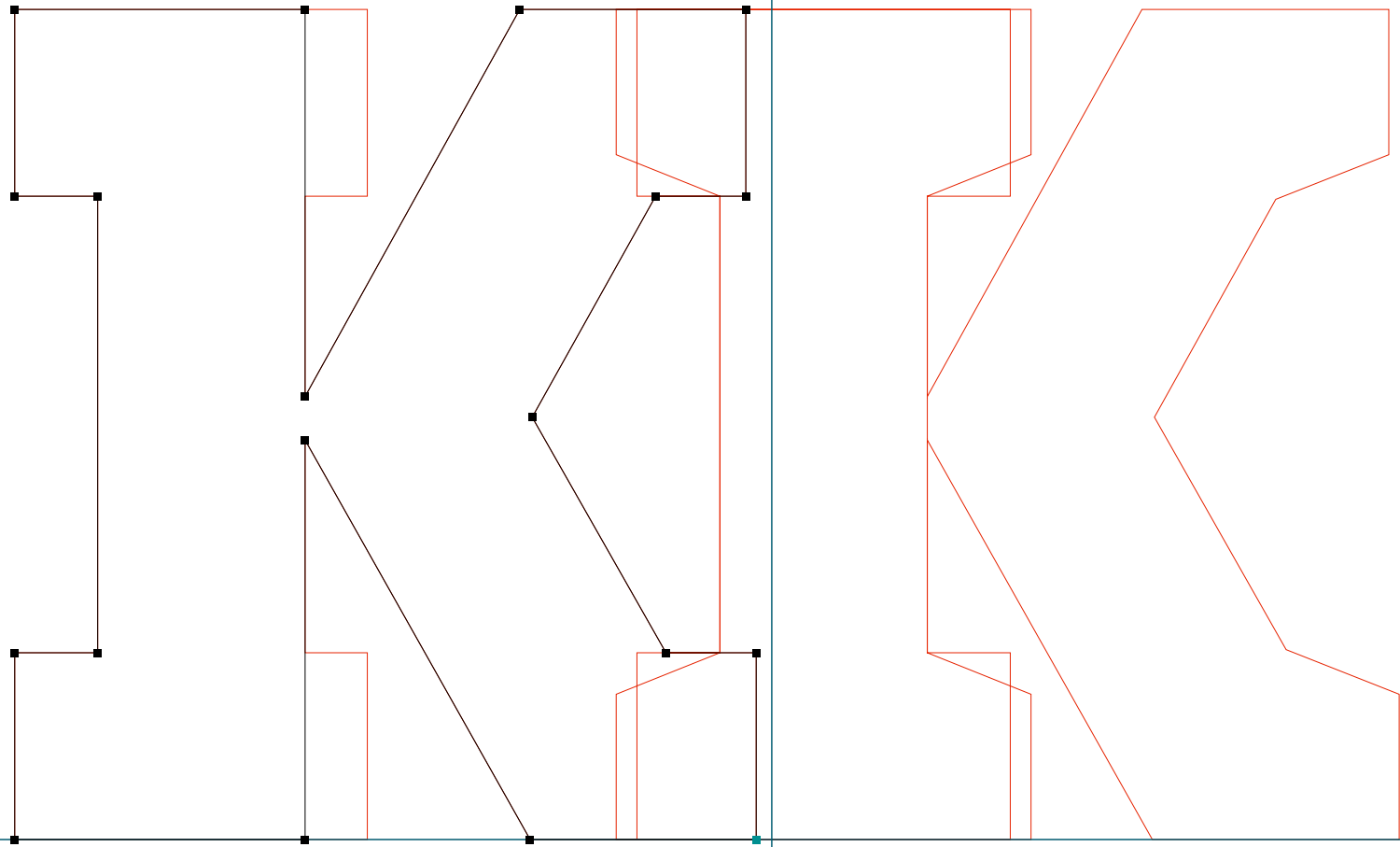

**BASE 9 & 12**

.....  
BaseTwelve SerifSCB | T | RoboFog Sketches | 1995 | Emigre Fonts

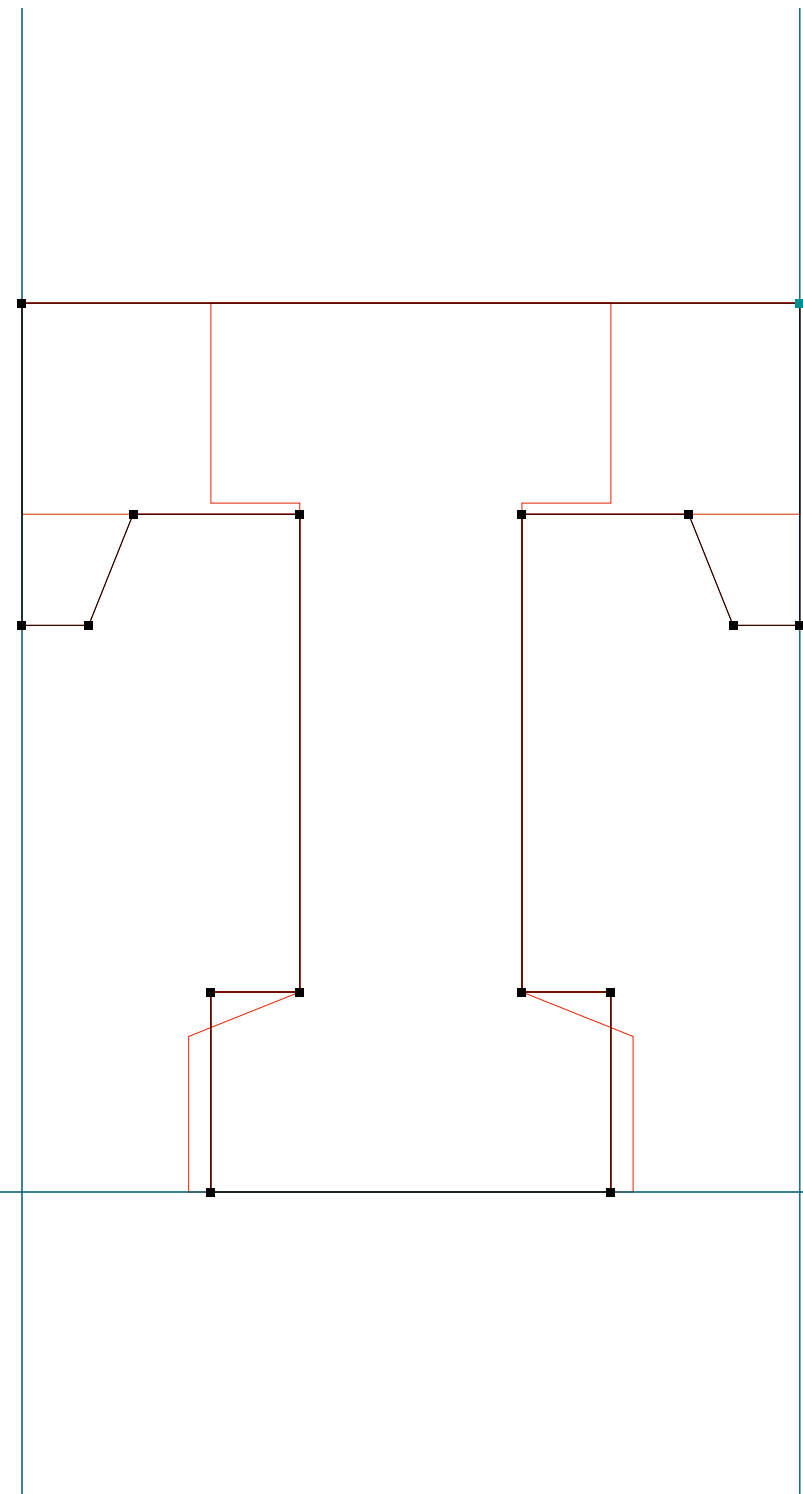

**BASE 9 & 12**

.....  
BaseTwelve SerifSCB | W | RoboFog Sketches | 1995 | Emigre Fonts

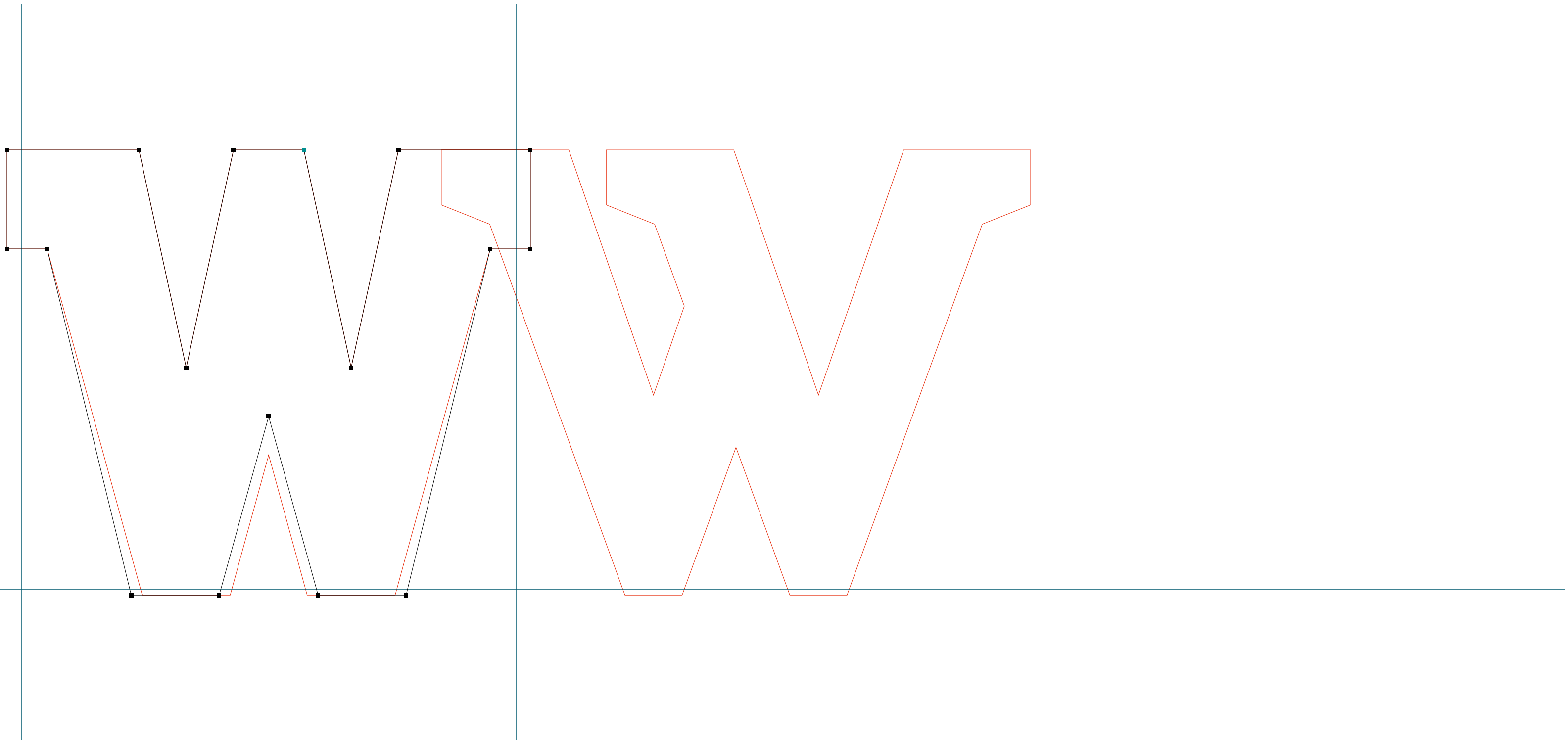

**BASE 9 & 12**

.....  
BaseTwelve SerifSCB | a | RoboFog Sketches | 1995 | Emigre Fonts

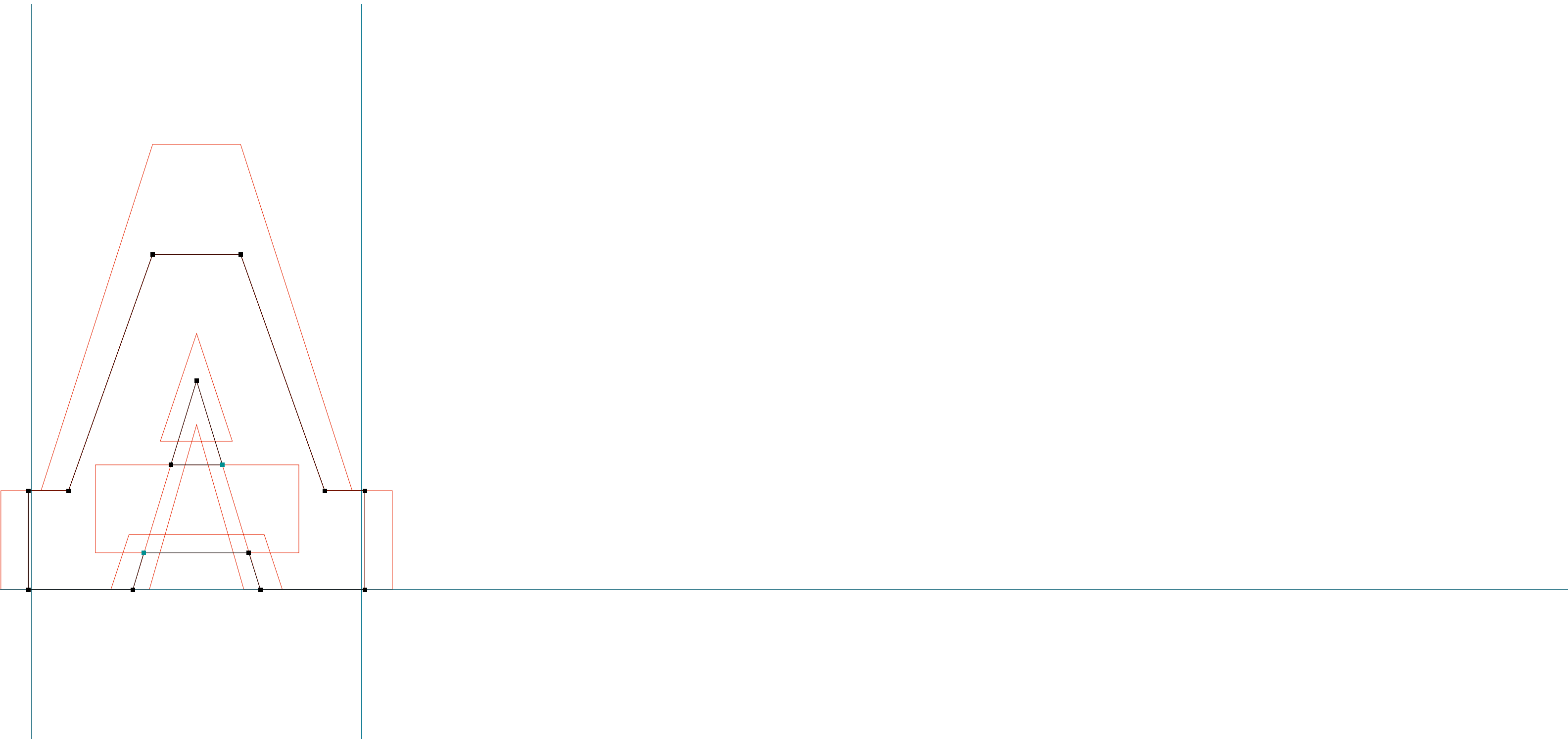

**BASE 9 & 12**

.....  
BaseTwelve SerifSCB | b | RoboFog Sketches | 1995 | Emigre Fonts

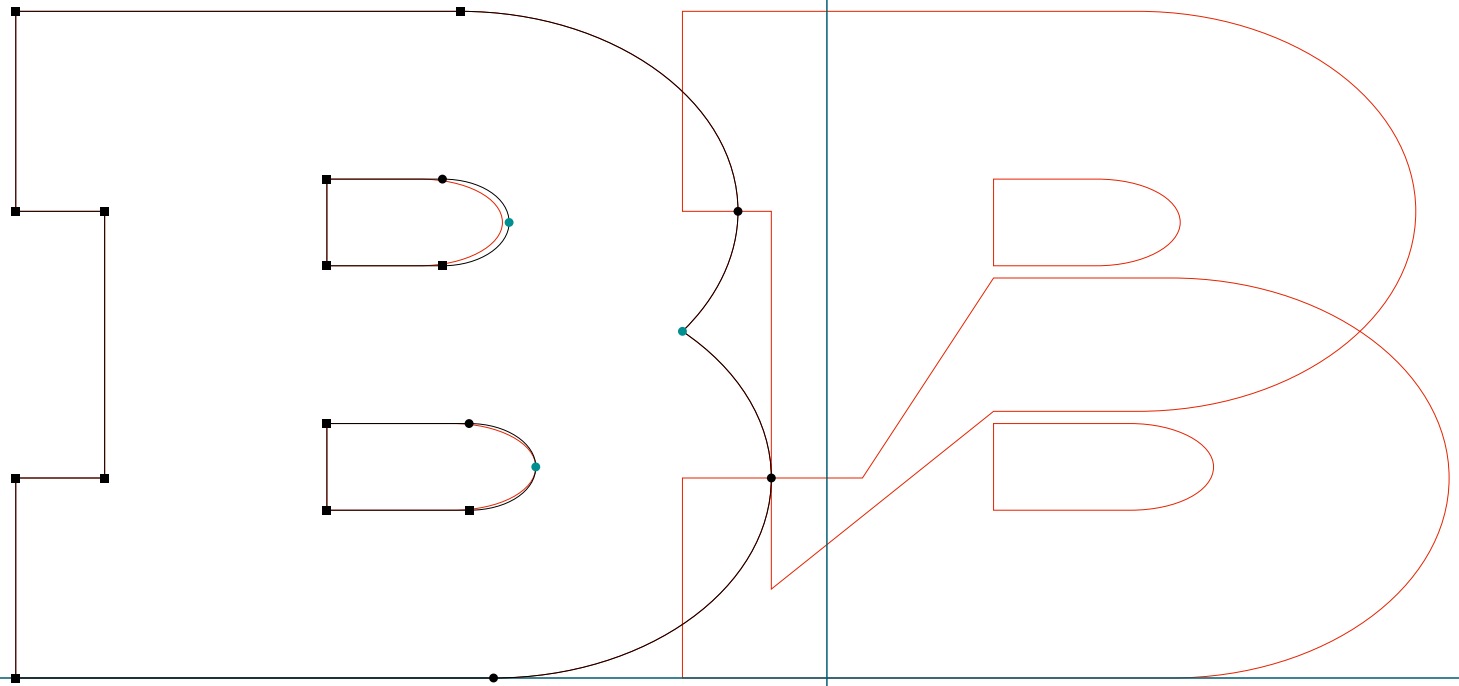

**BASE 9 & 12**

.....  
BaseTwelve SerifSCB | c | RoboFog Sketches | 1995 | Emigre Fonts

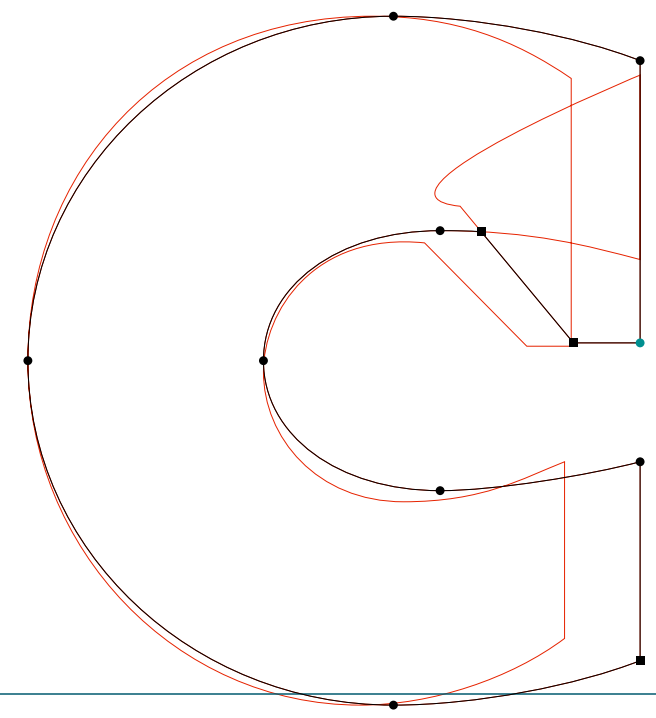

**BASE 9 & 12**

.....  
BaseTwelve SerifSCB | g | RoboFog Sketches | 1995 | Emigre Fonts

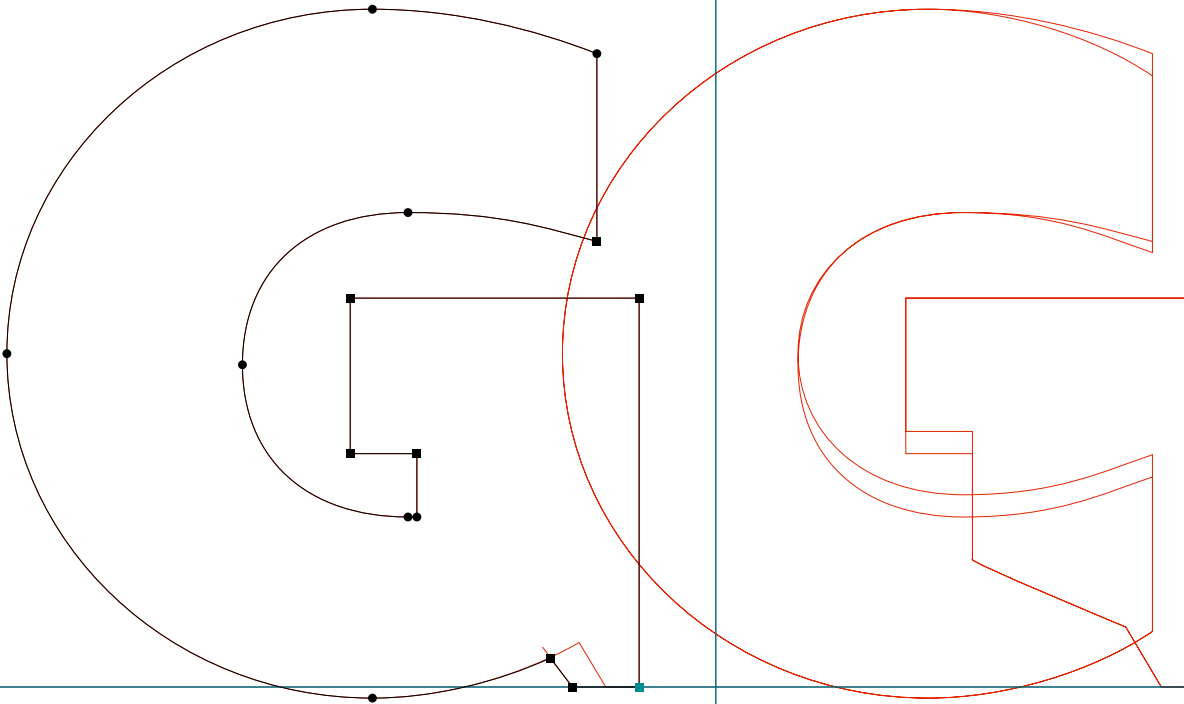

**BASE 9 & 12**

.....  
BaseTwelve SerifSCB | p | RoboFog Sketches | 1995 | Emigre Fonts

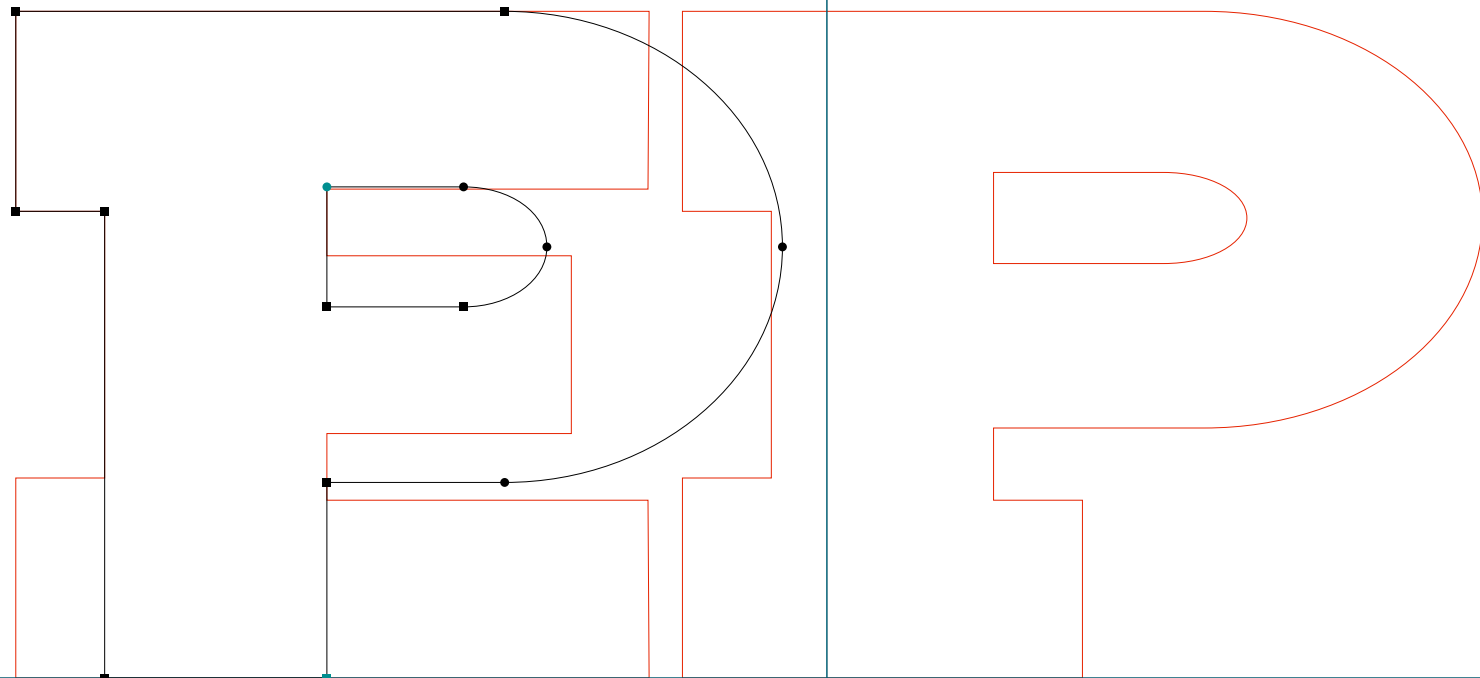



**BASE 9 & 12**

.....  
BaseTwelve SerifSCB | s | RoboFog Sketches | 1995 | Emigre Fonts

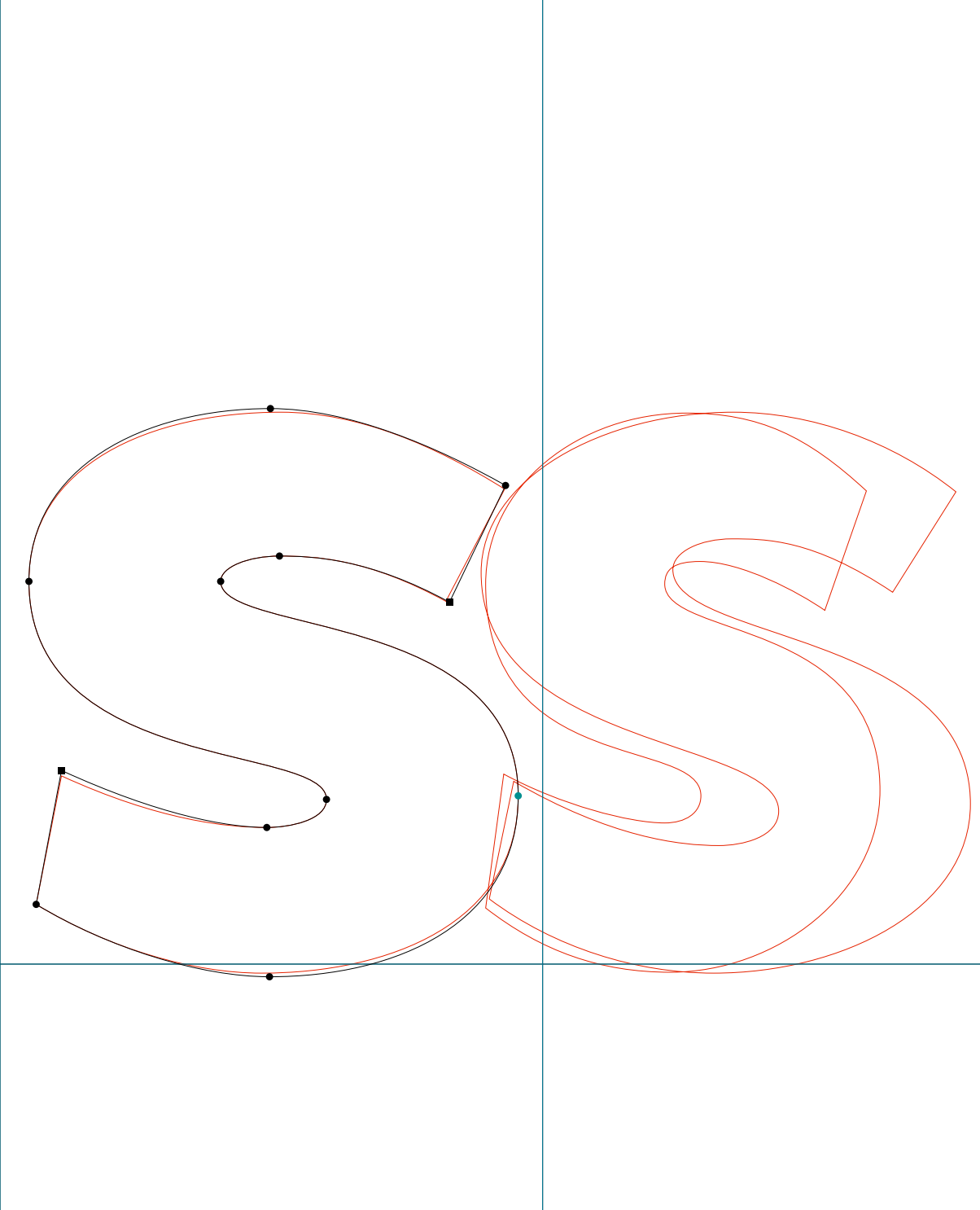

**BASE 9 & 12**

.....  
BaseTwelve SerifSCBI | six | RoboFog Sketches | 1995 | Emigre Fonts

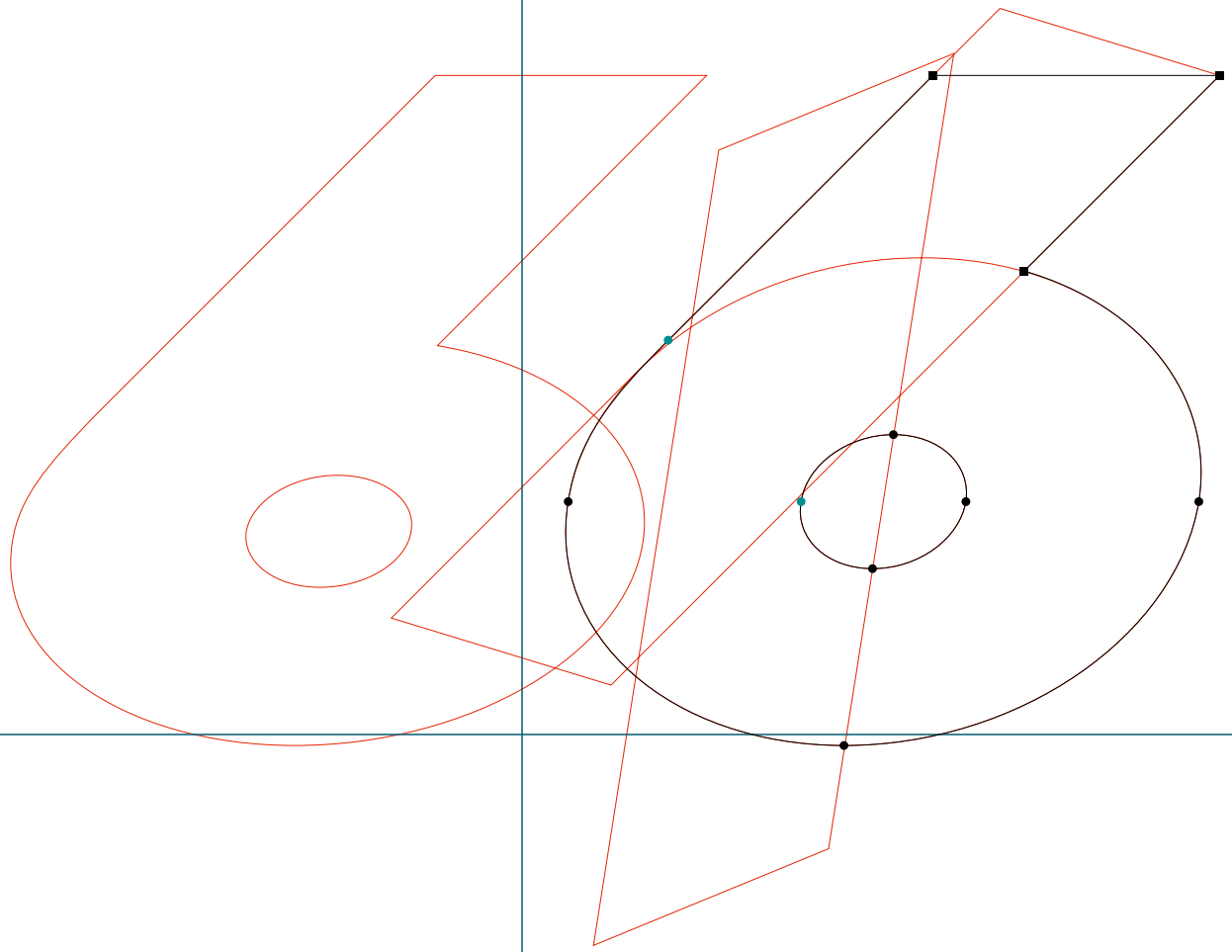

**BASE 9 & 12**

.....  
BaseTwelve SerifSCBI | A | RoboFog Sketches | 1995 | Emigre Fonts

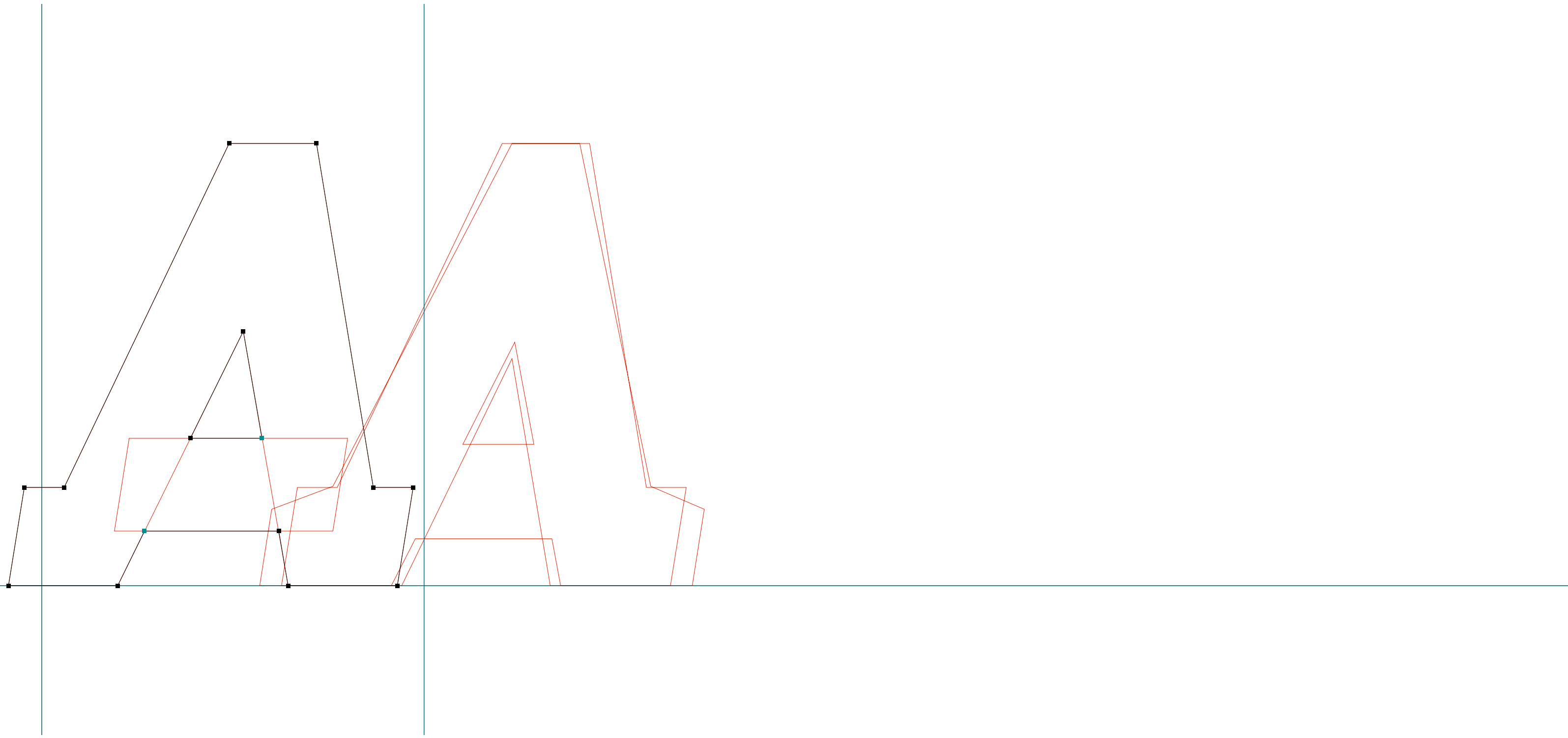

**BASE 9 & 12**

.....  
BaseTwelve SerifSCBI | B | RoboFog Sketches | 1995 | Emigre Fonts

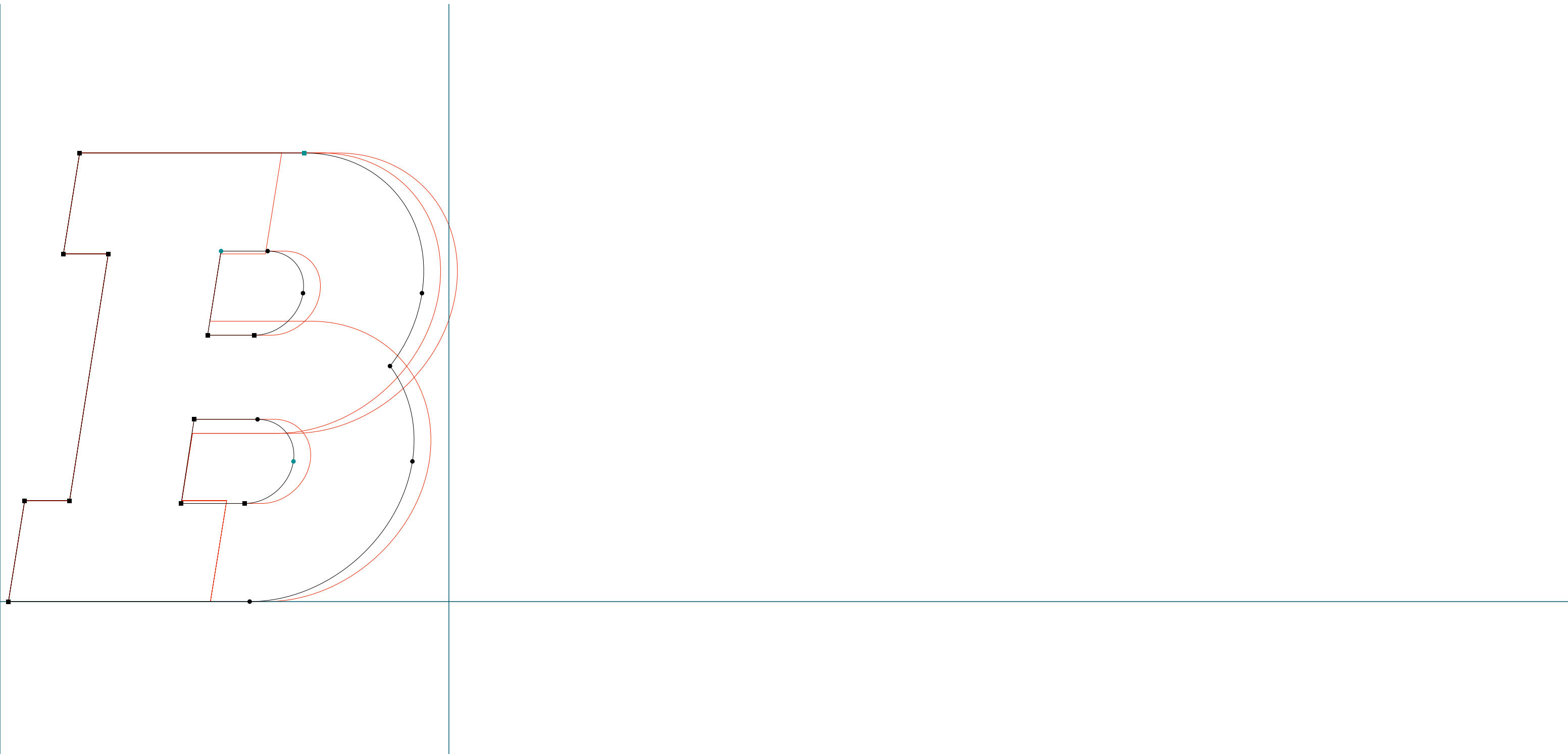

**BASE 9 & 12**

.....  
BaseTwelve SerifSCBI | C | RoboFog Sketches | 1995 | Emigre Fonts

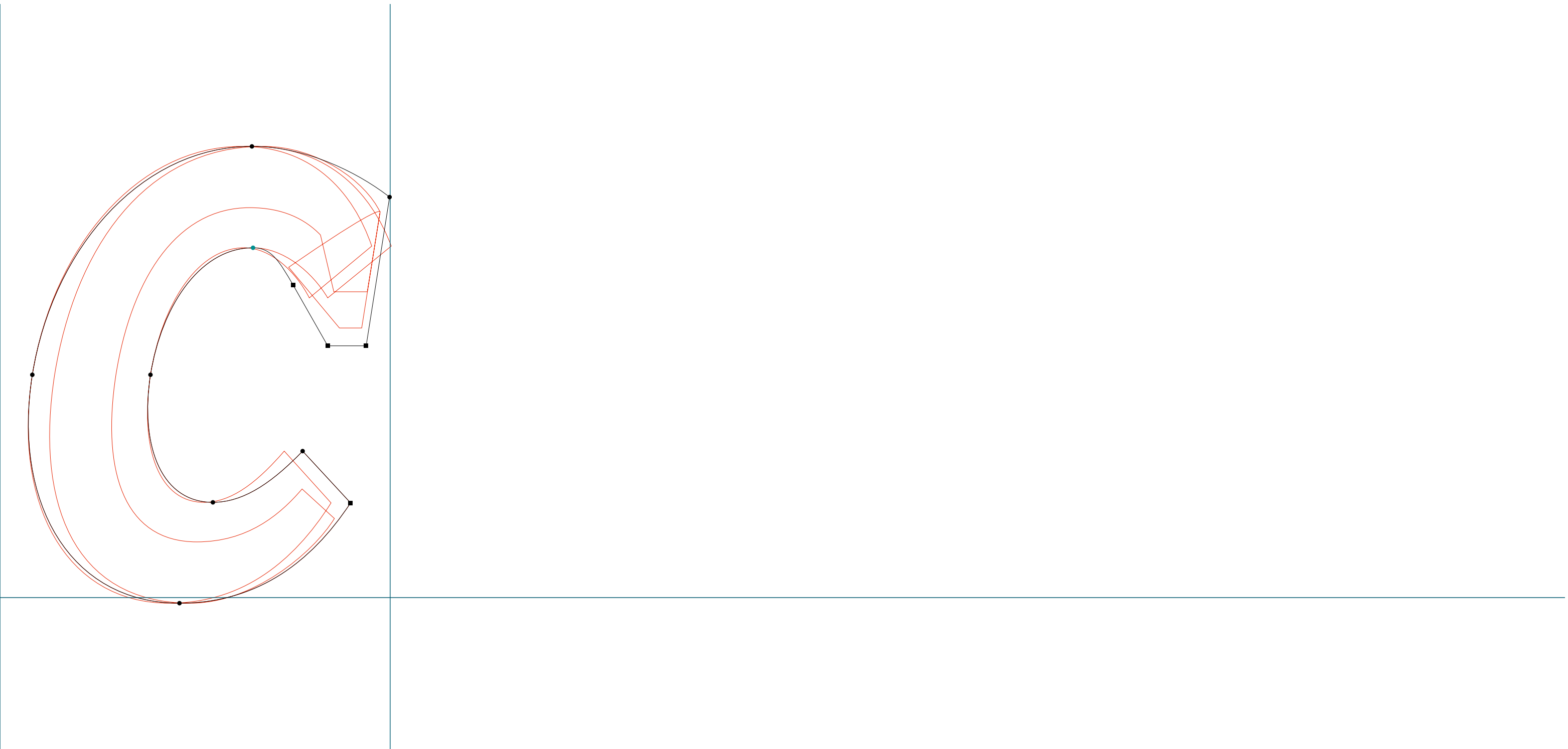

**BASE 9 & 12**

.....  
BaseTwelve SerifSCBI | H | RoboFog Sketches | 1995 | Emigre Fonts

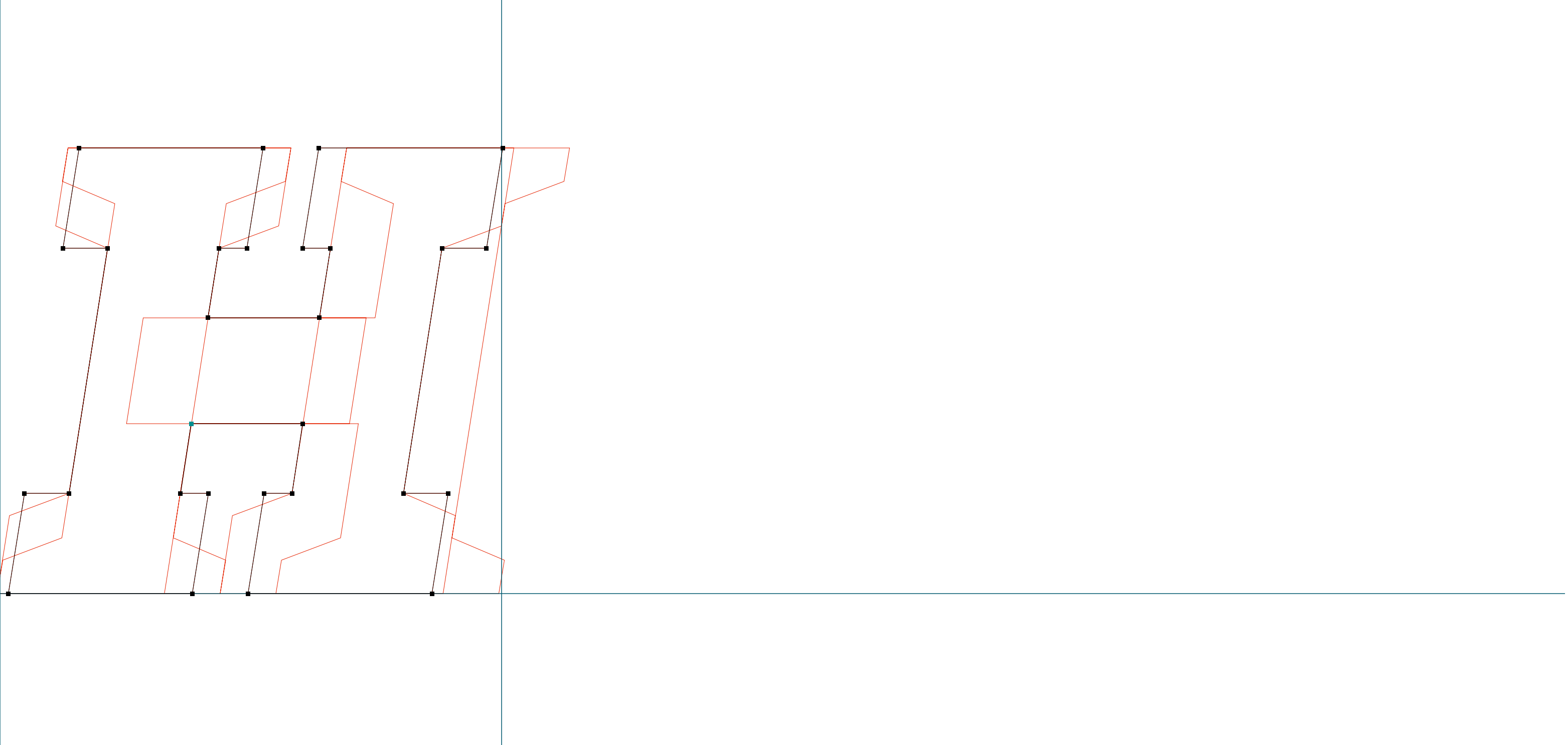

**BASE 9 & 12**

.....  
BaseTwelve SerifSCBI | I | RoboFog Sketches | 1995 | Emigre Fonts

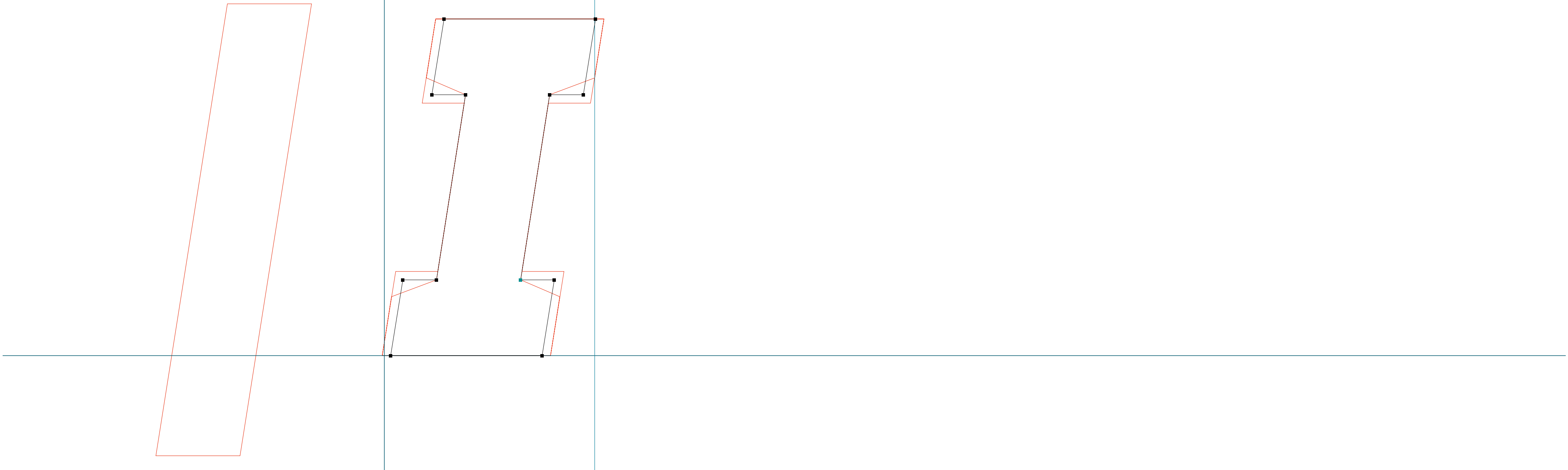

**BASE 9 & 12**

.....  
BaseTwelve SerifSCBI | K | RoboFog Sketches | 1995 | Emigre Fonts

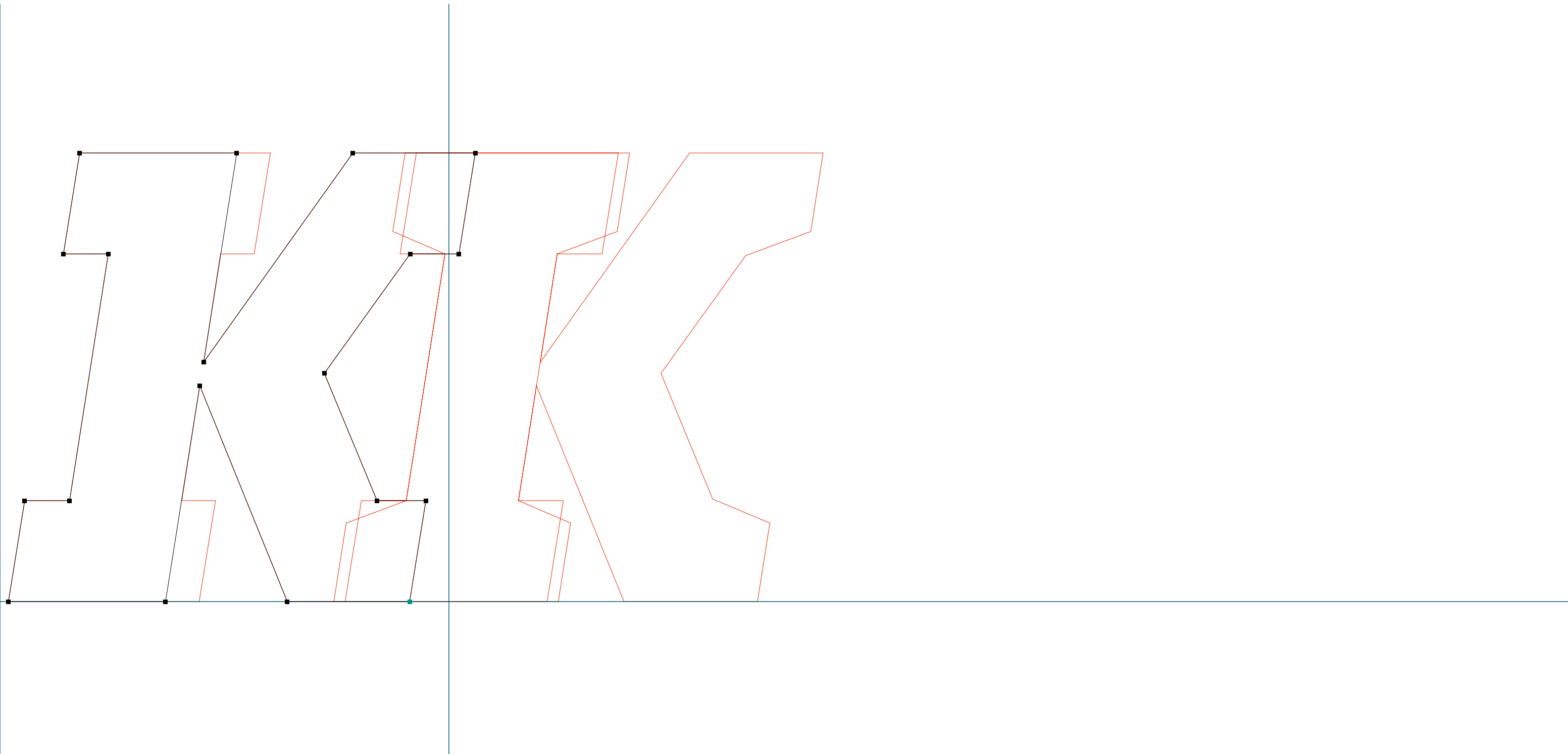



**BASE 9 & 12**

.....  
BaseTwelve SerifSCBI | T | RoboFog Sketches | 1995 | Emigre Fonts

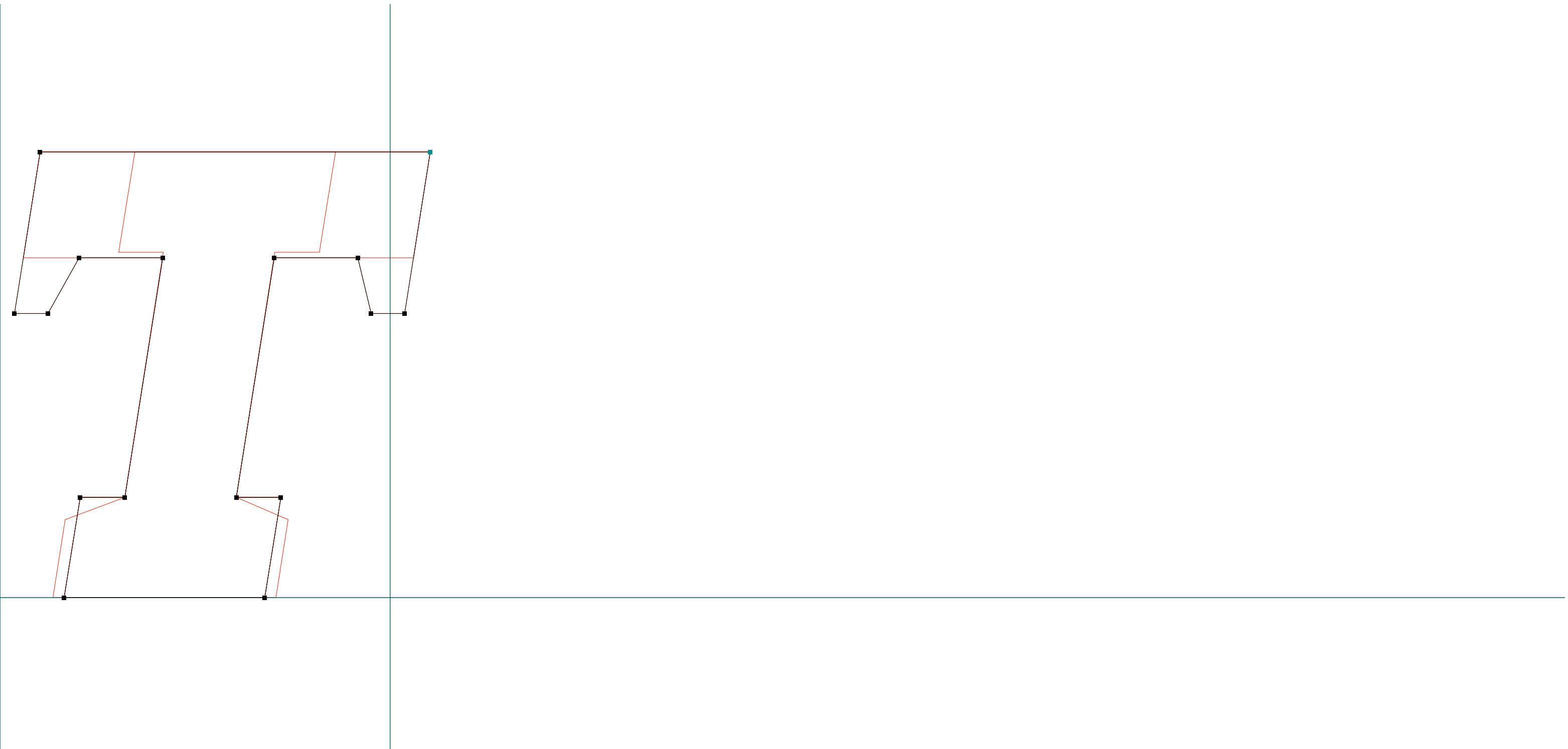

**BASE 9 & 12**

.....  
BaseTwelve SerifSCBI | W | RoboFog Sketches | 1995 | Emigre Fonts

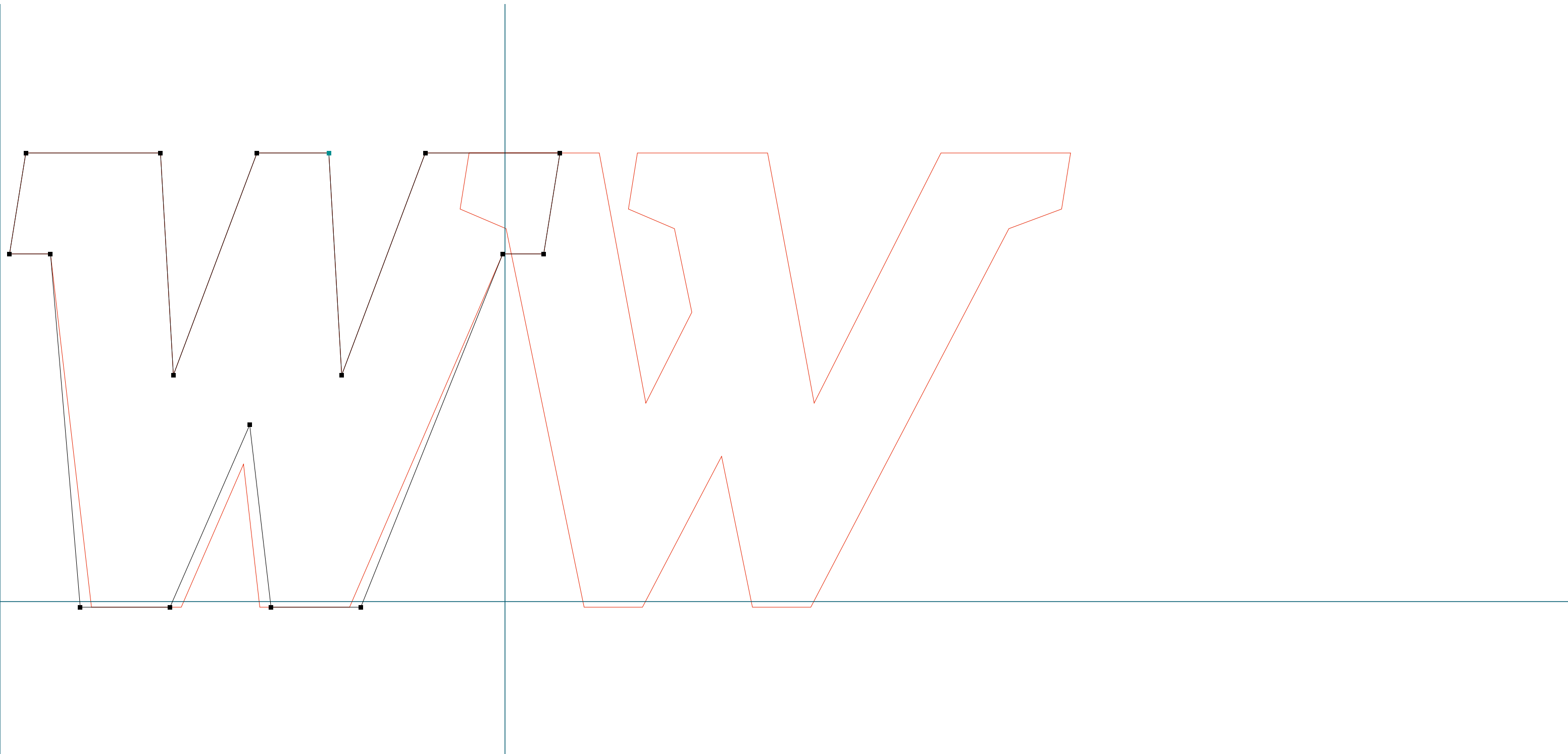

**BASE 9 & 12**

.....  
BaseTwelve SerifSCBI | a | RoboFog Sketches | 1995 | Emigre Fonts

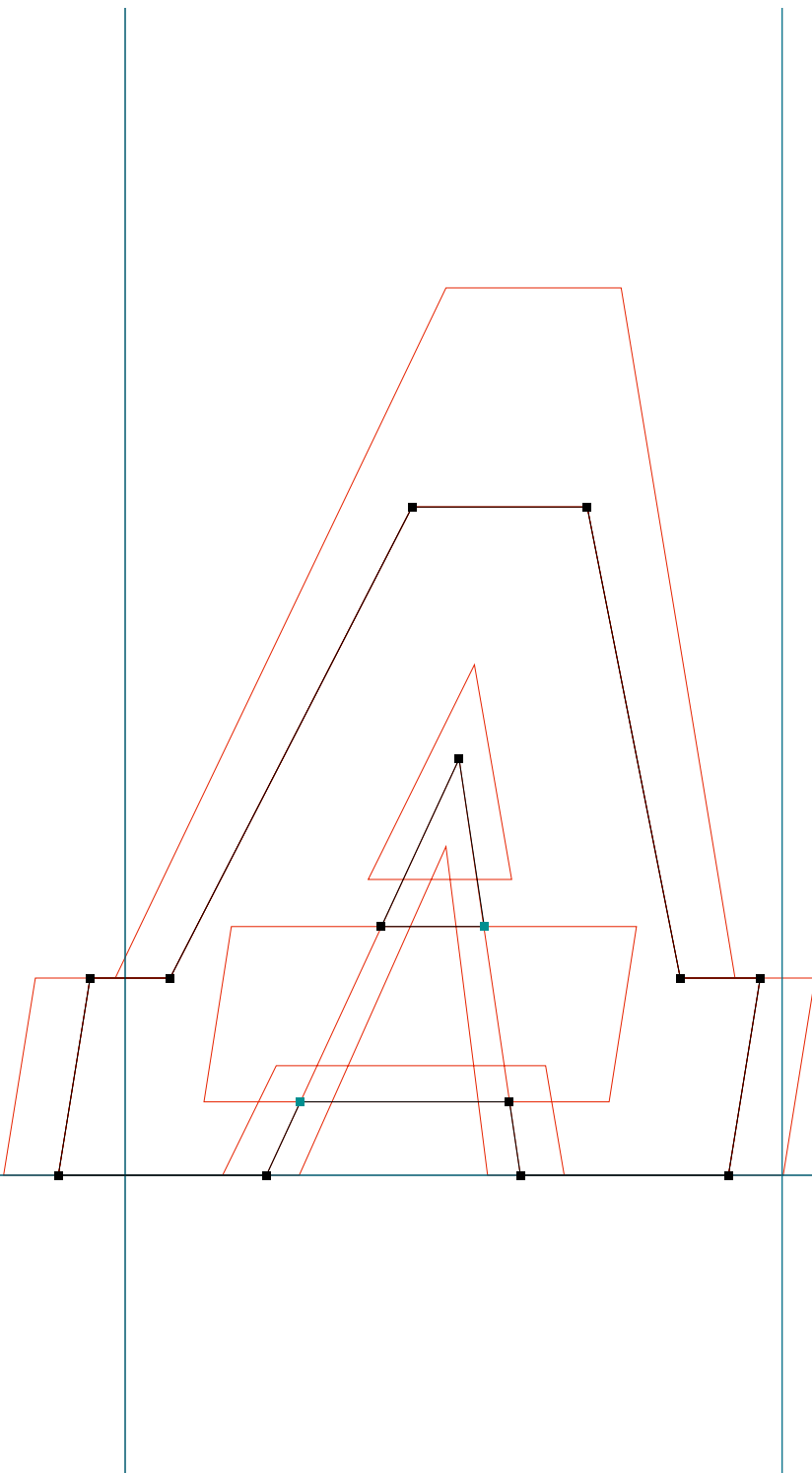

**BASE 9 & 12**

.....  
BaseTwelve SerifSCBI | b | RoboFog Sketches | 1995 | Emigre Fonts

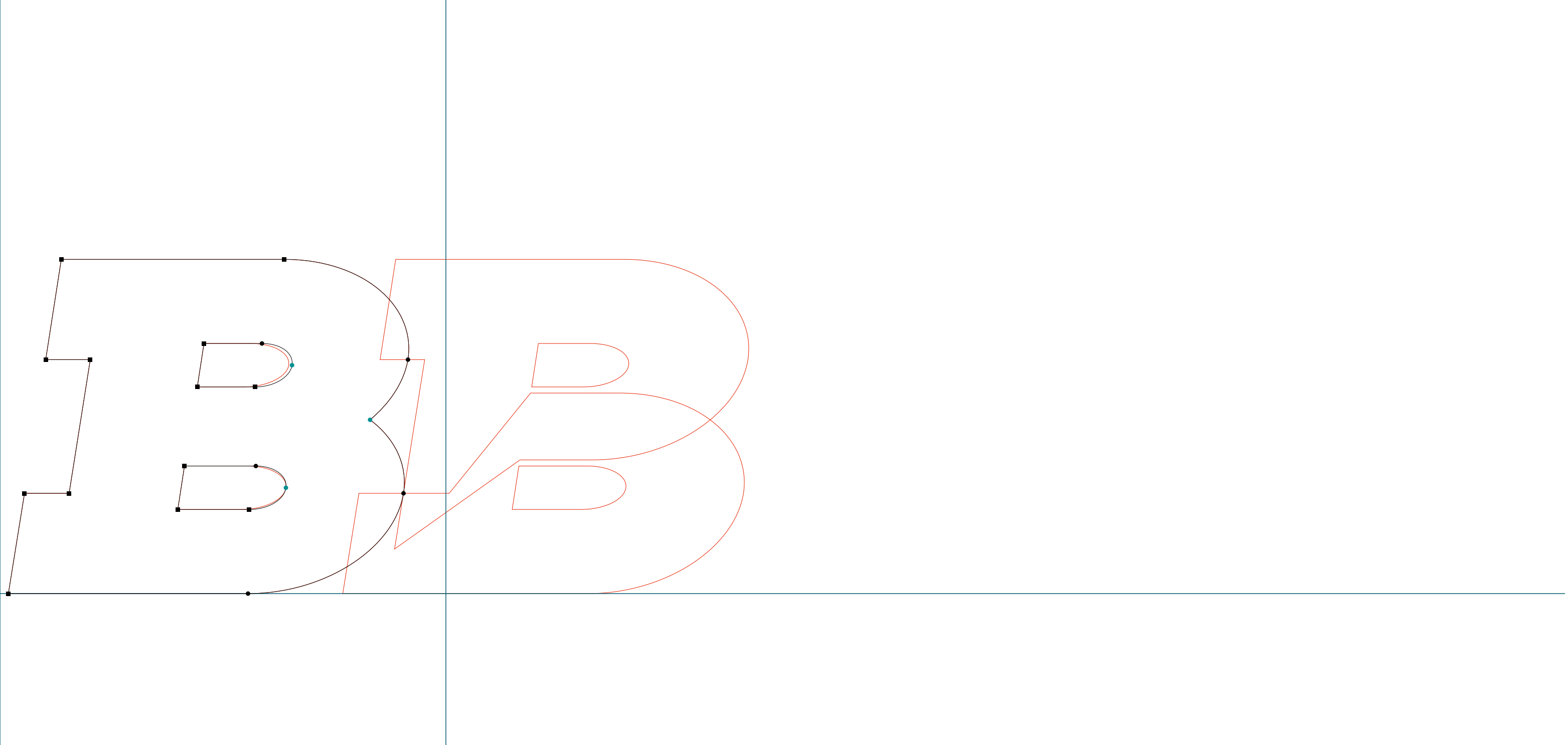

**BASE 9 & 12**

BaseTwelve SerifSCBI | c | RoboFog Sketches | 1995 | Emigre Fonts

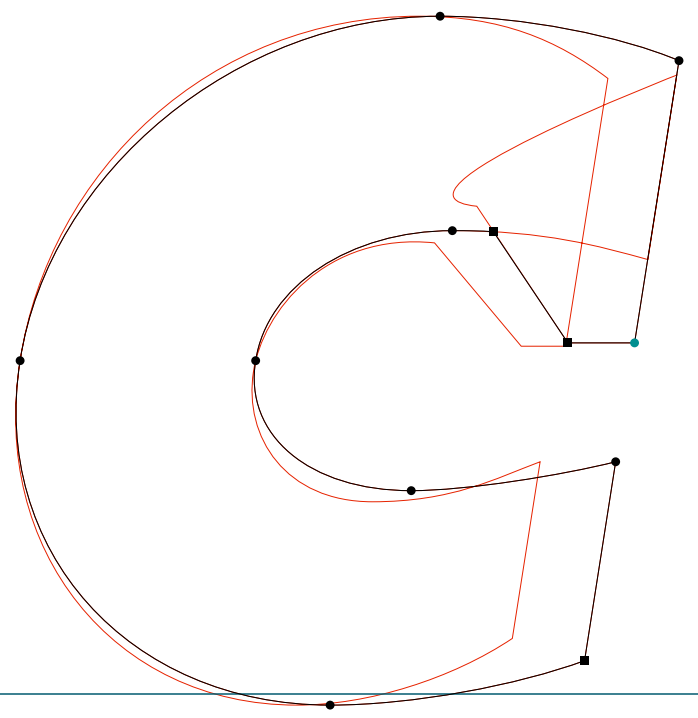

**BASE 9 & 12**

.....  
BaseTwelve SerifSCBI | p | RoboFog Sketches | 1995 | Emigre Fonts

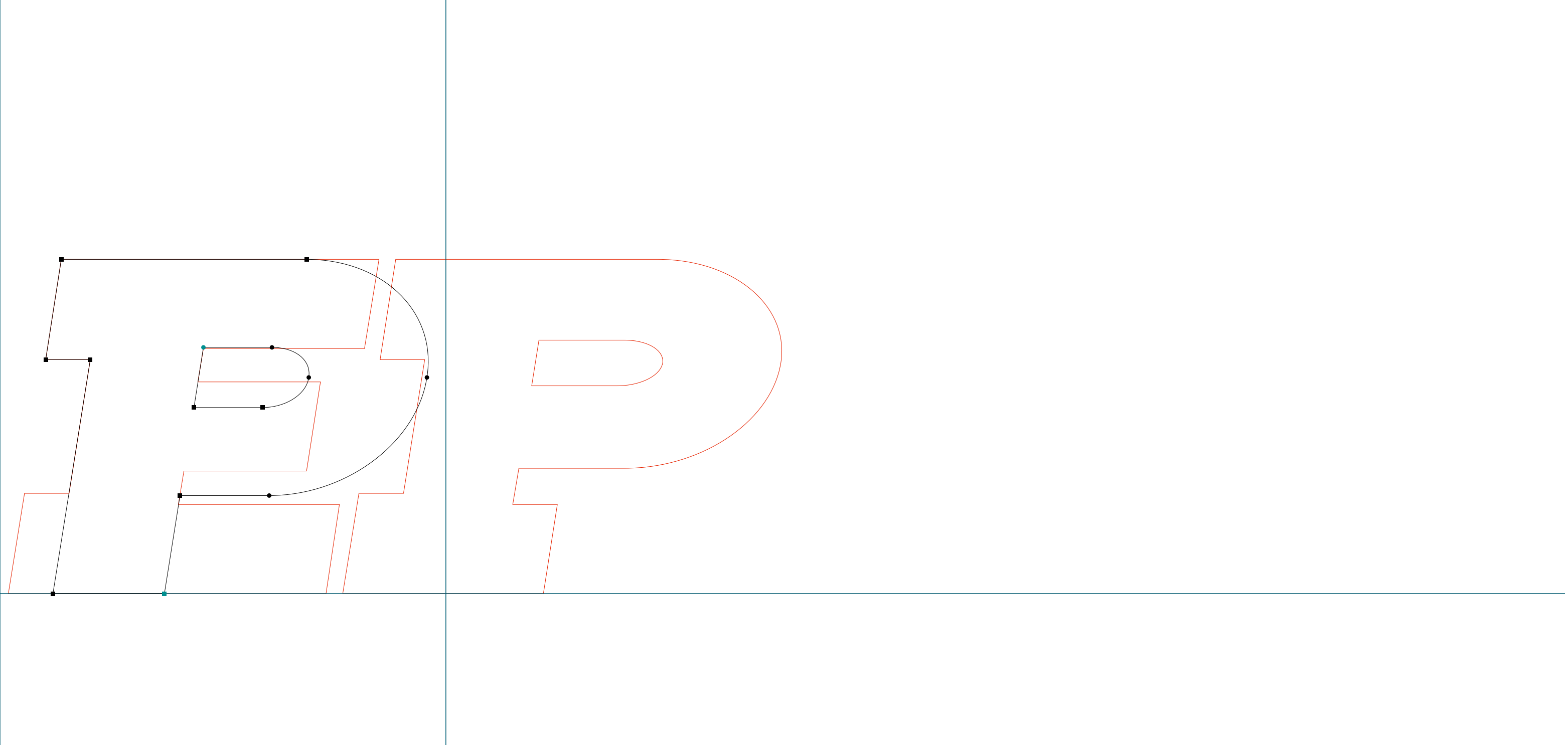

**BASE 9 & 12**

.....  
BaseTwelve SerifSCBI | s | RoboFog Sketches | 1995 | Emigre Fonts

