

PROGRAM

Designed by Zuzana Licko in 2013.

Program is a type designer’s typeface. It is about the craft of typeface design and the particular details and effects that type designers fret over when they design type. It mixes different structures, stem endings, and weight distributions not usually employed in a single family of fonts. It features both rounded edges evoking the effects of reproduction, and ink traps, the technique used to counteract that effect. The idea was to create a series of fonts with strong individualistic features, challenging the constraints of a central theme that is usually imposed on a family of fonts, while still relating to each other in terms of overall look and feel.

Program has four weights, while Program Narrow has three. Instead of matching the overall “color” in text settings between the Program and Program Narrow versions, as is often done, the stem weights were matched. This allows for a more comfortable matching of stem weights when combining the two versions at larger sizes on posters or in headlines.

Structurally, the Program type family would be difficult to classify as it mixes different structural models:
<www.emigre.com/assets/img/fonts/description/ProgramProcess.png>
Program Book, for instance, with its low contrast, has the features of a Neo-Grotesque with slight Humanist tendencies that are most visible in the calligraphic, brush-like tail endings of the lowercase a, d, b, k, u, and capital R and K. Program Narrow is decidedly more Modern in structure, with pronounced vertical stress carried throughout all characters.

Program and Program Narrow diverge most notably in the design of the a, c, e and s in both lowercase and capitals. In Program, the terminals of these curved characters are vertical. This opens up the counter spaces and increases legibility, contributing to its fitness as a text font. In Program Narrow the terminals are horizontal. Bending the

curves into themselves like this accentuates the verticality of Program Narrow. The effect also creates more compact letter shapes making it a suitable headline font.

For more information, see:
<<https://www.emigre.com/Fonts/Program>>

More Digital Font Sketches:
<<https://www.emigre.com/DigitalFontSketches>>

PROGRAM

.....
Program Book | dollar | RoboFog Sketches | 2013 | Emigre Fonts

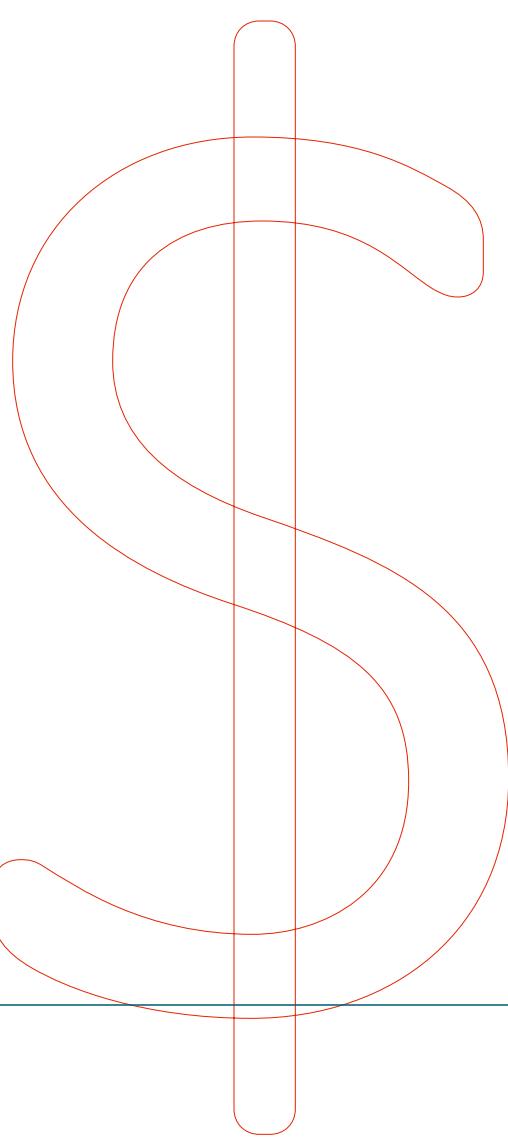
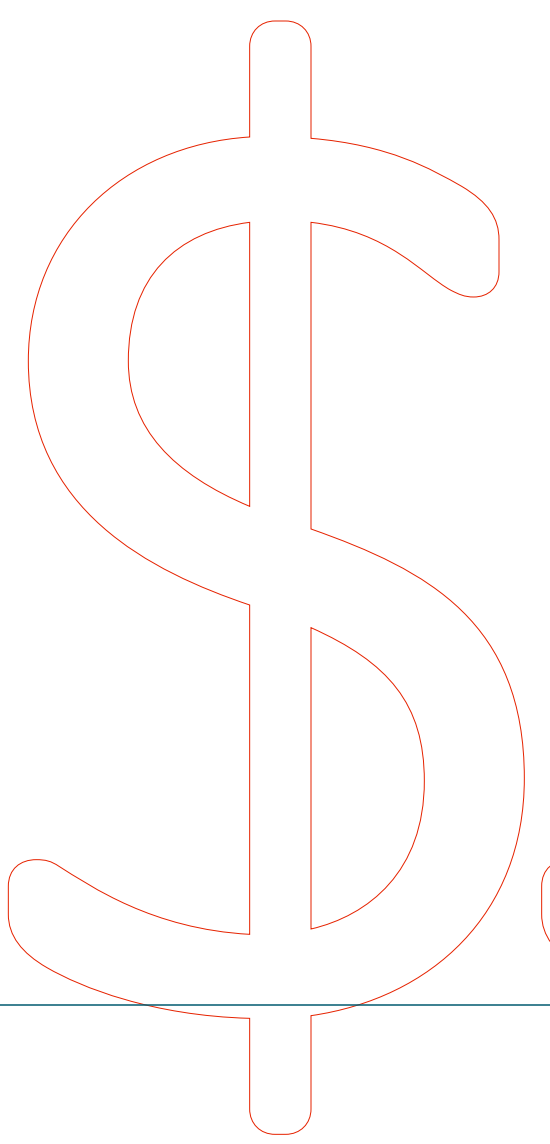
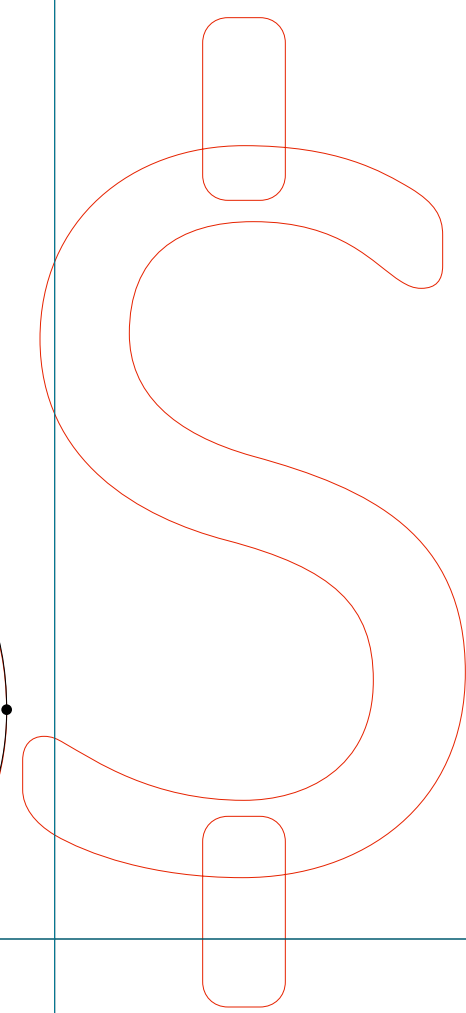
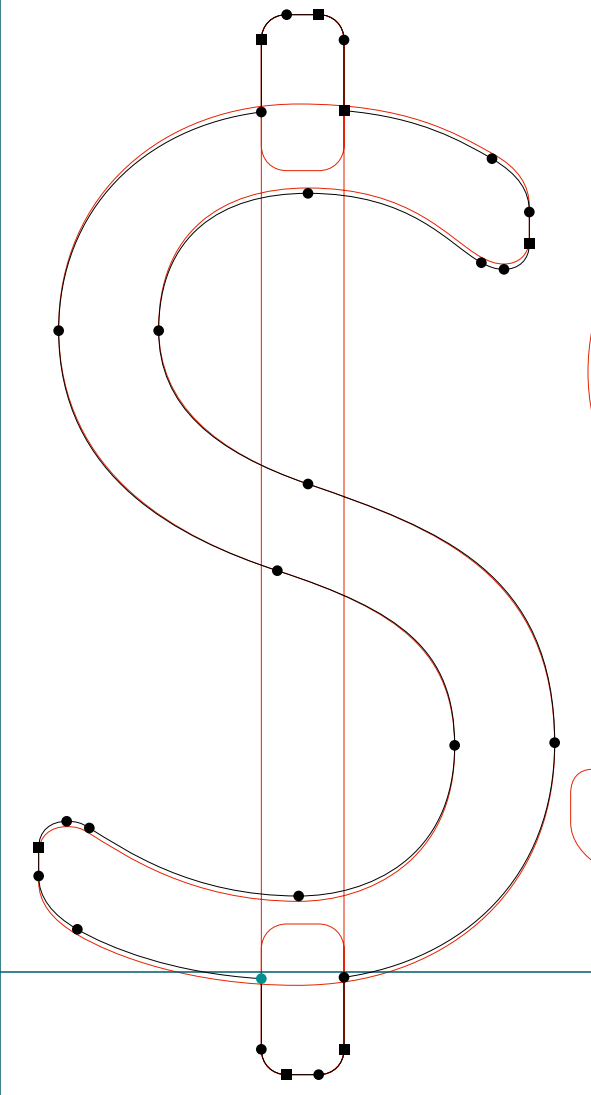
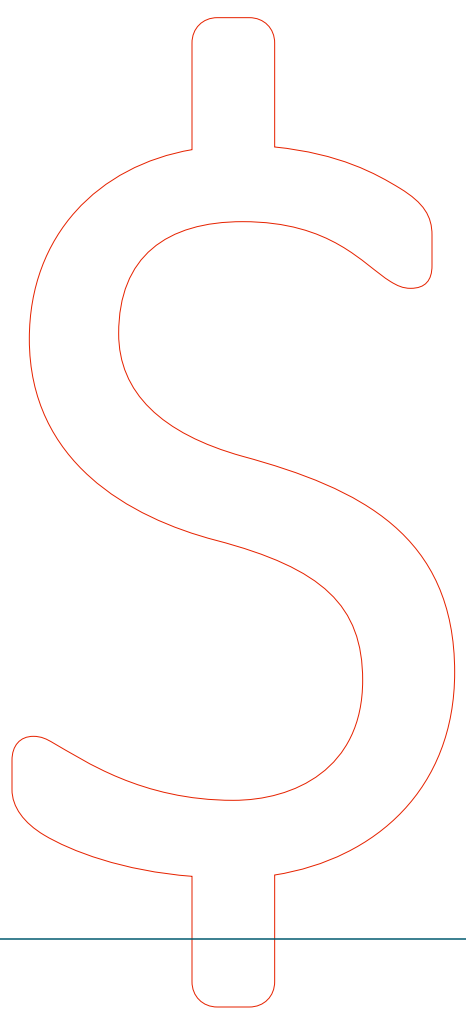

PROGRAM

.....
Program Book | ampersand | RoboFog Sketches | 2013 | Emigre Fonts

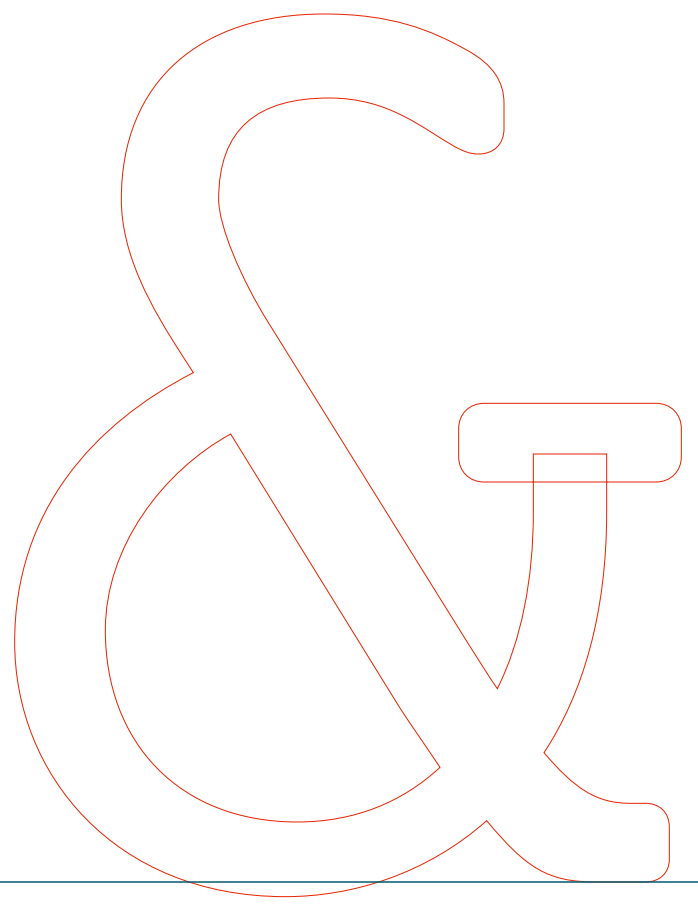
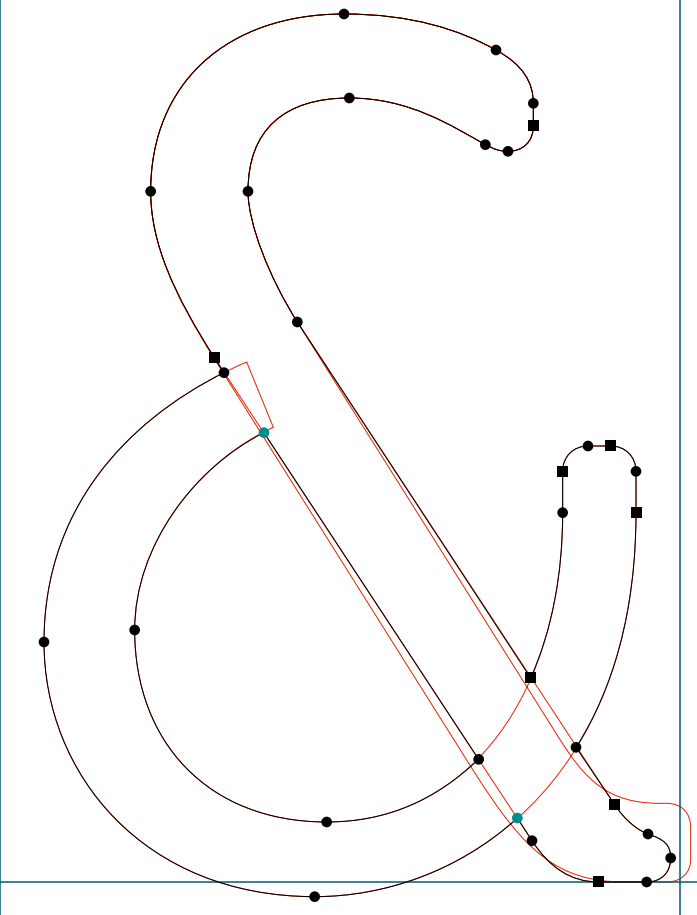

PROGRAM

.....
Program Book | asterisk | RoboFog Sketches | 2013 | Emigre Fonts

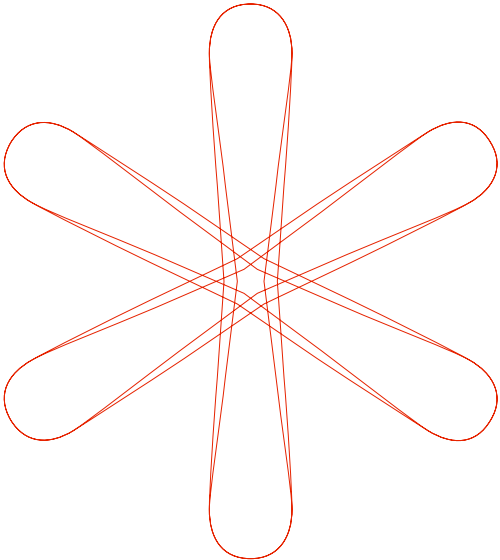
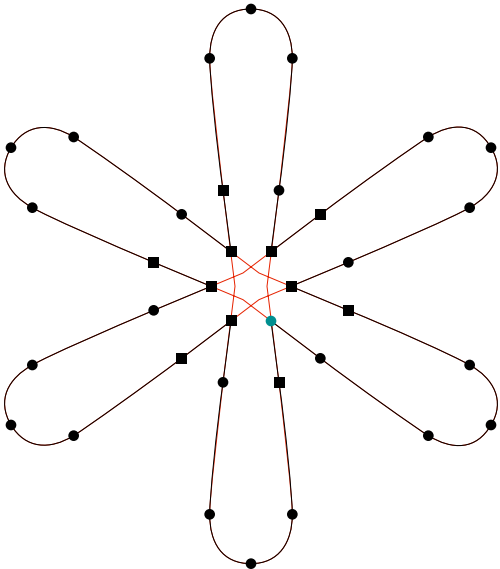

PROGRAM

.....
Program Book | comma | RoboFog Sketches | 2013 | Emigre Fonts

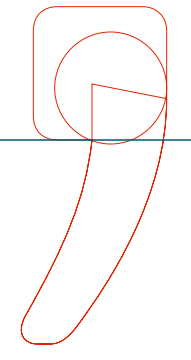
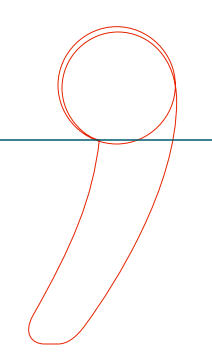
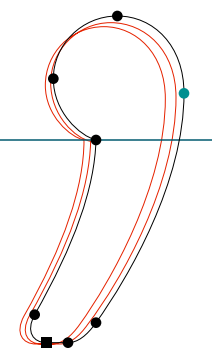
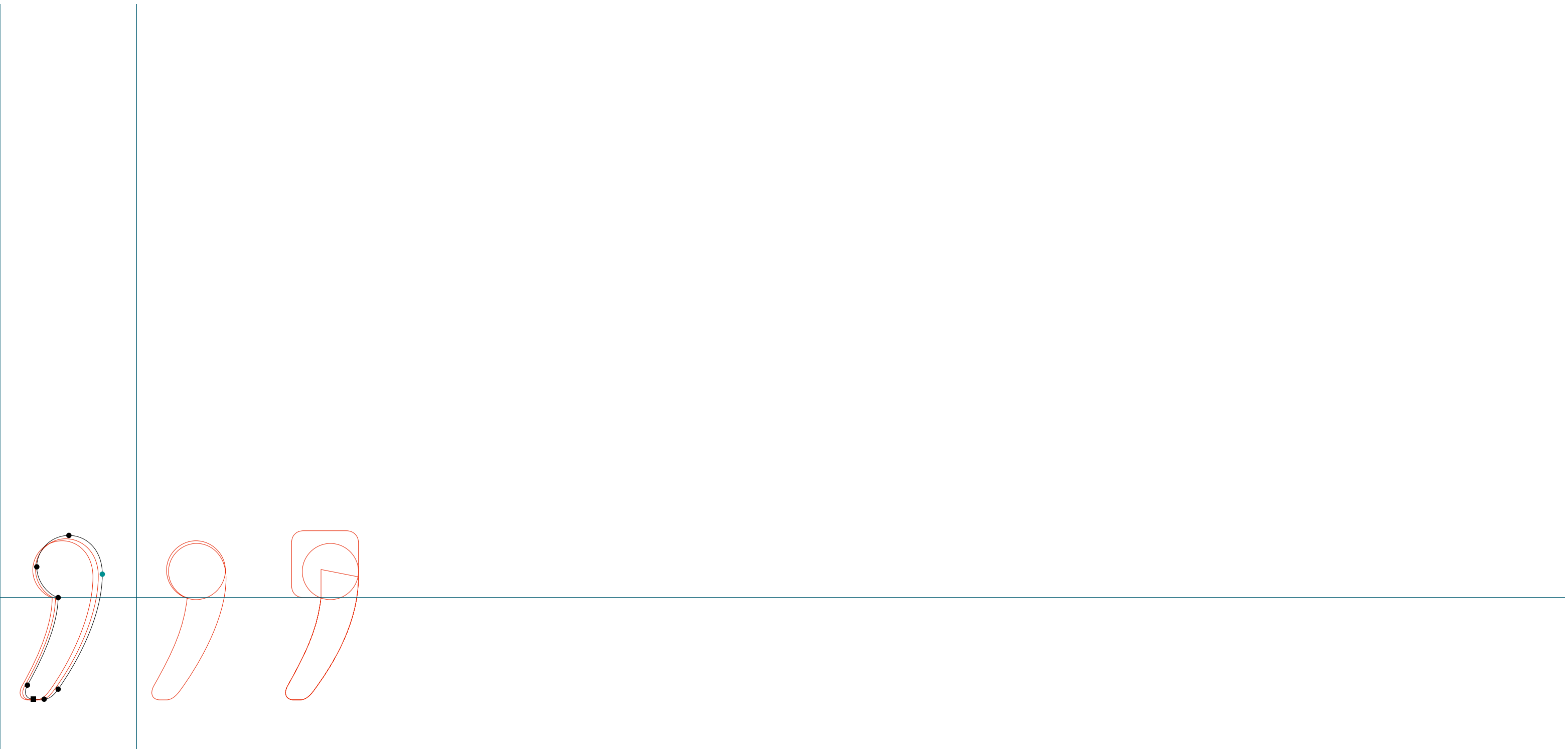

PROGRAM

.....
Program Book | period | RoboFog Sketches | 2013 | Emigre Fonts

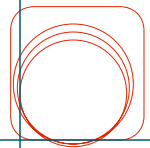
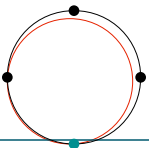

PROGRAM

.....
Program Book | five | RoboFog Sketches | 2013 | Emigre Fonts

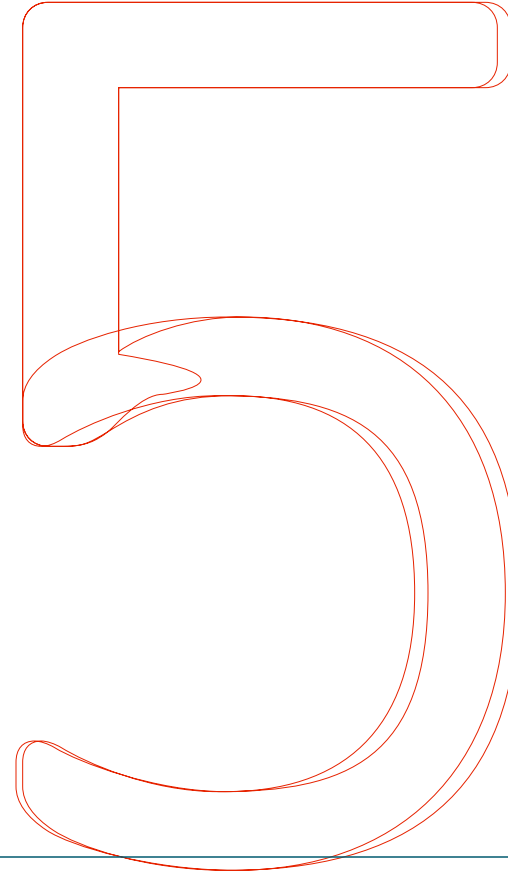
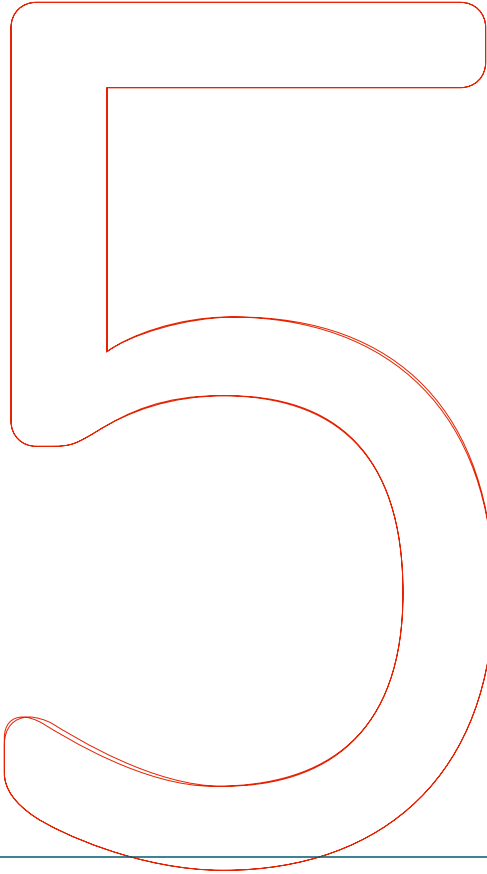
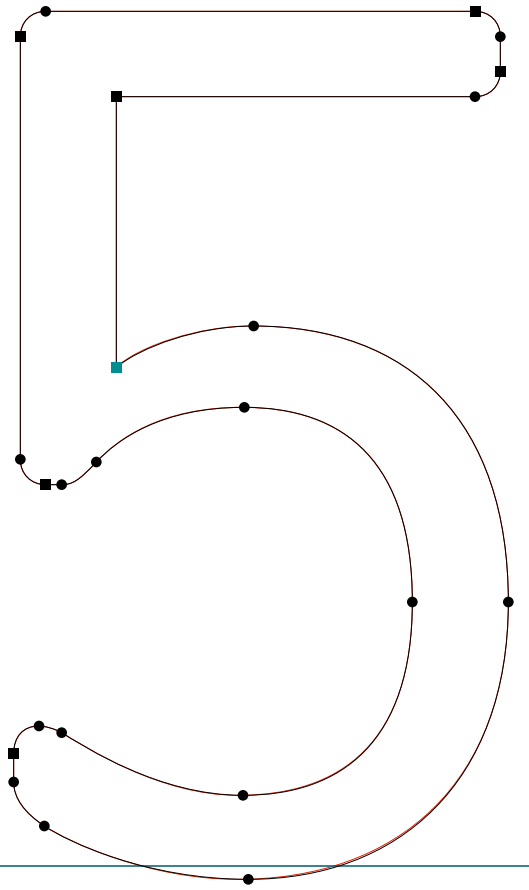
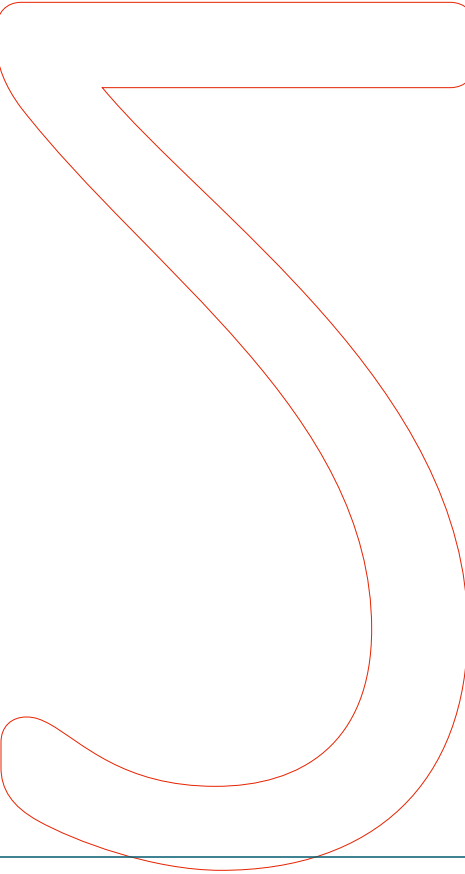

PROGRAM

.....
Program Book | eight | RoboFog Sketches | 2013 | Emigre Fonts

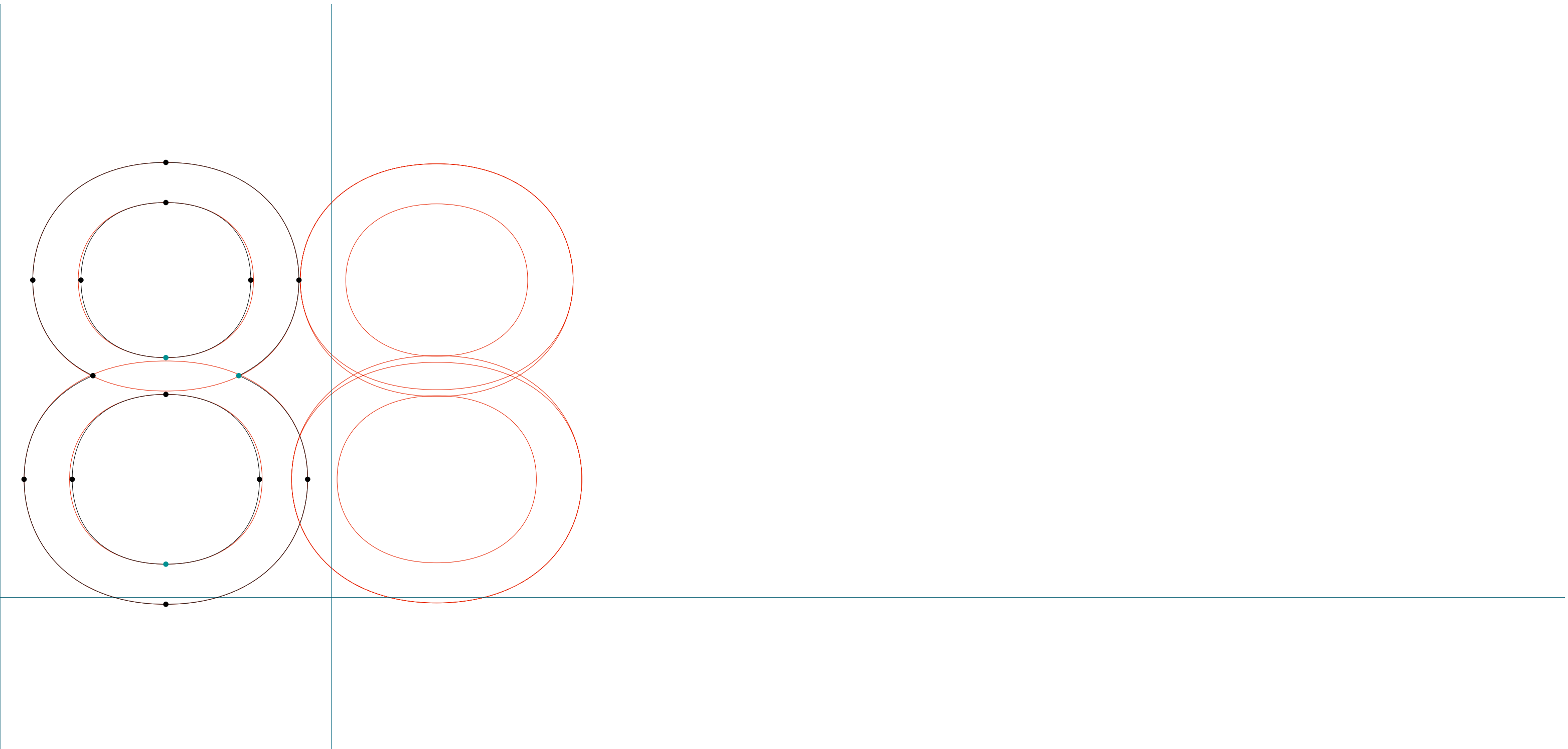

PROGRAM

.....
Program Book | semicolon | RoboFog Sketches | 2013 | Emigre Fonts

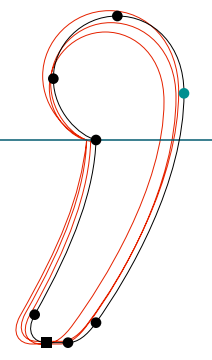
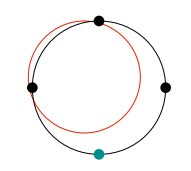

PROGRAM

.....
Program Book | A | RoboFog Sketches | 2013 | Emigre Fonts



PROGRAM

.....
Program Book | G | RoboFog Sketches | 2013 | Emigre Fonts



PROGRAM

Program Book | M | RoboFog Sketches | 2013 | Emigre Fonts

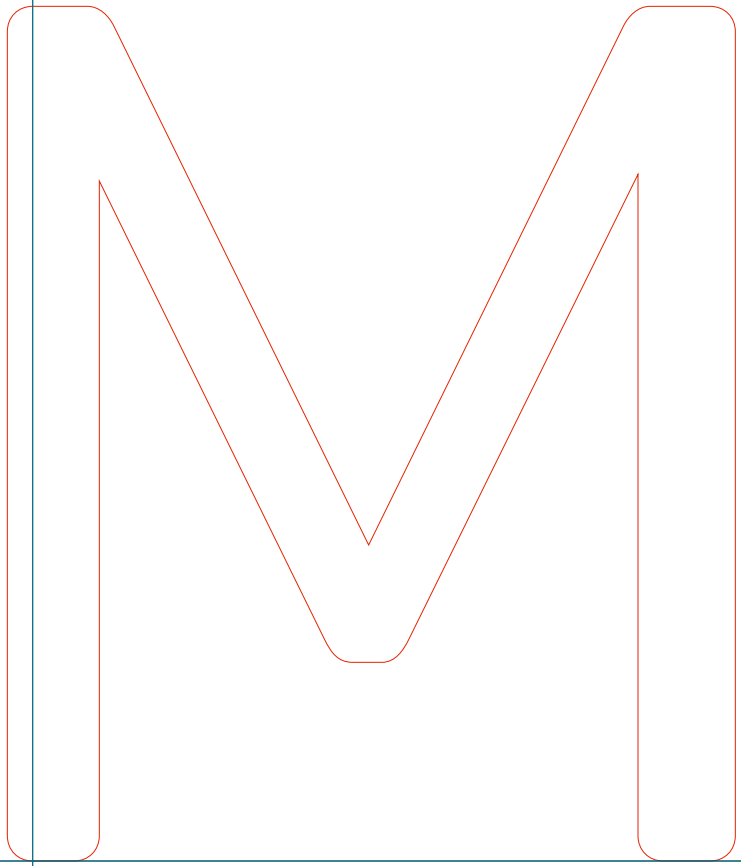
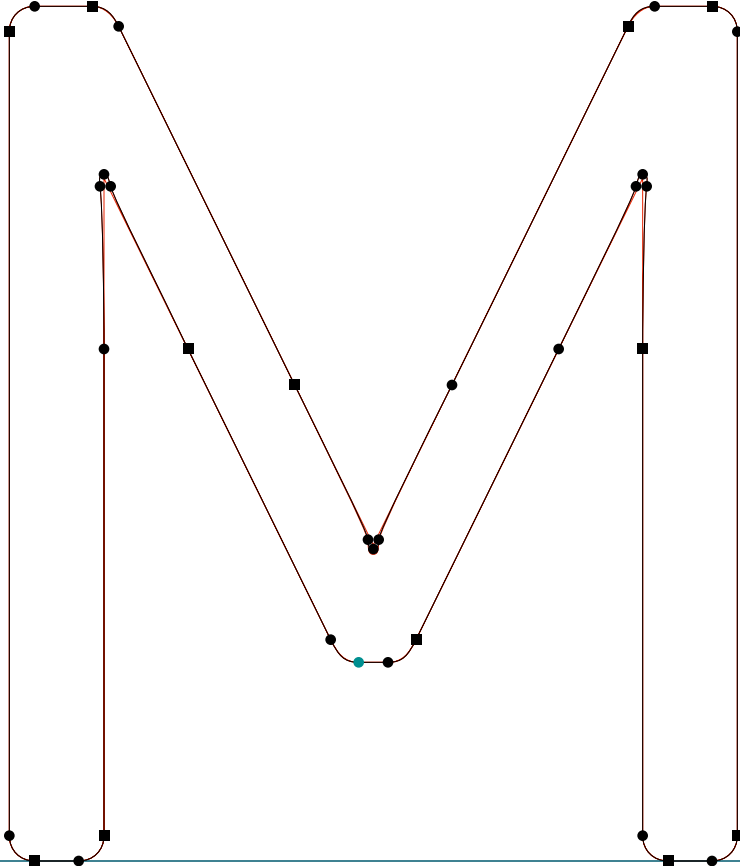

PROGRAM

.....
Program Book | P | RoboFog Sketches | 2013 | Emigre Fonts

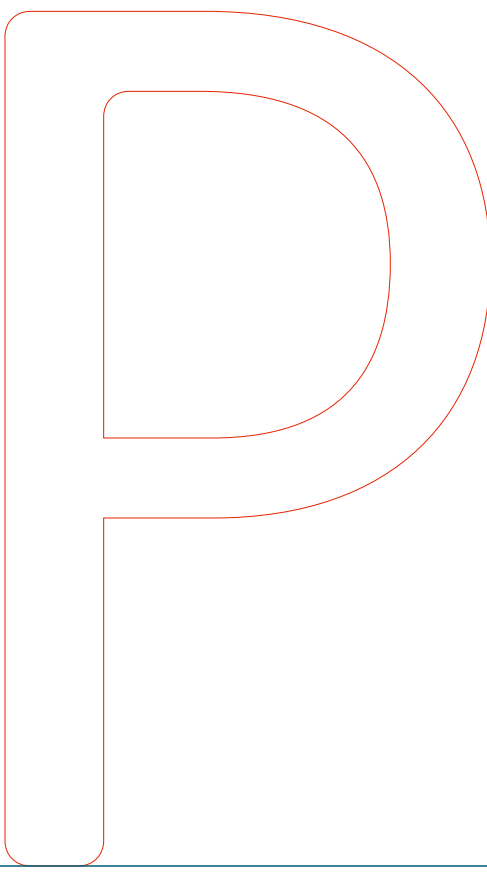
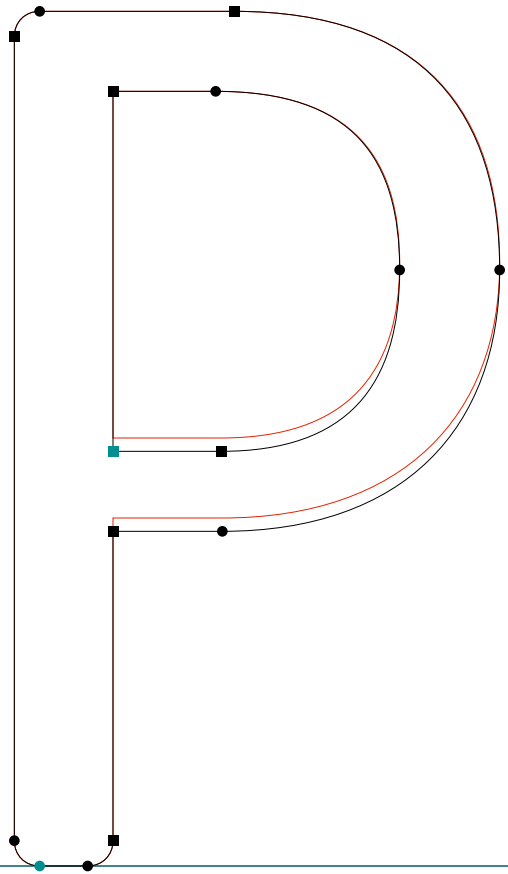

PROGRAM

.....
Program Book | Q | RoboFog Sketches | 2013 | Emigre Fonts

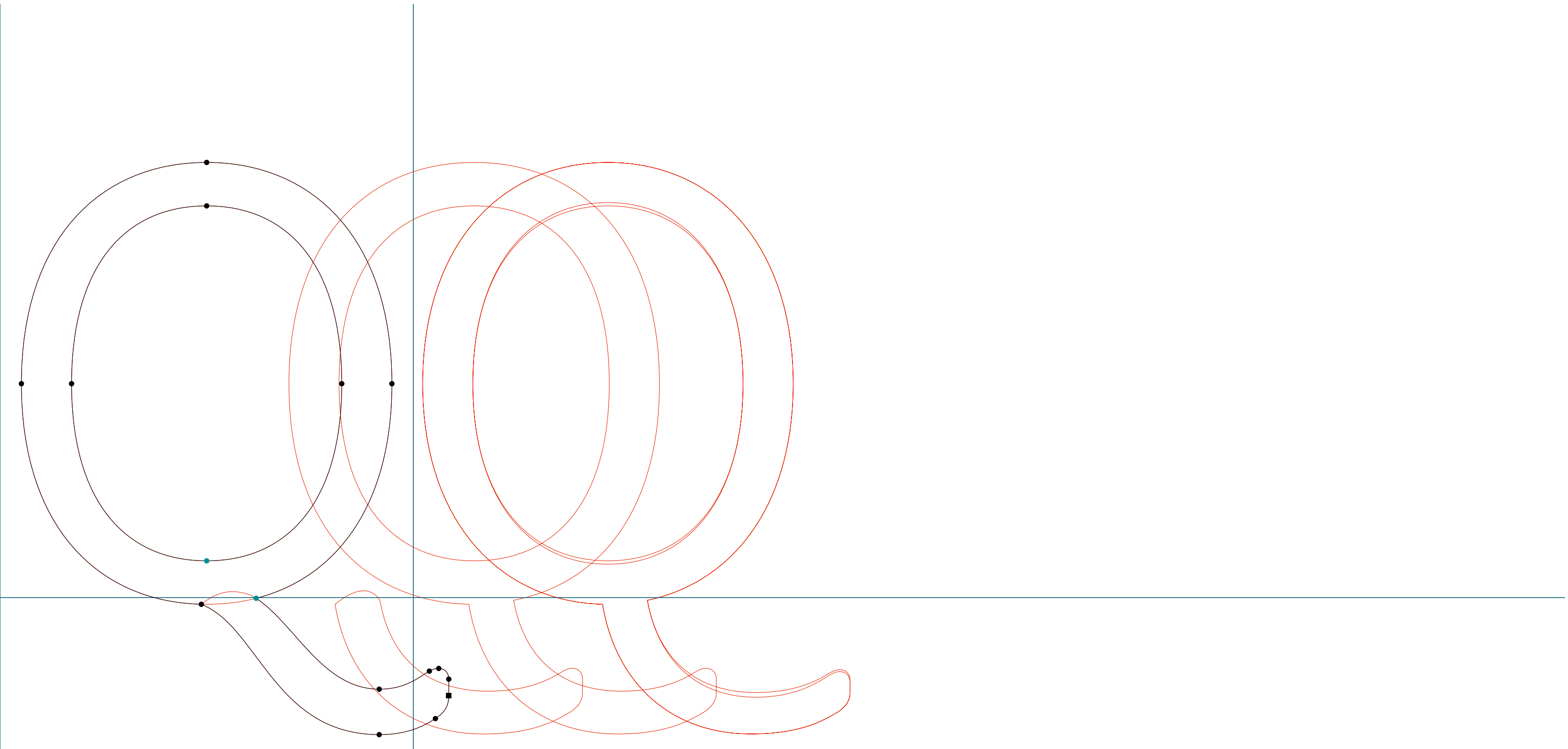

PROGRAM

.....
Program Book | R | RoboFog Sketches | 2013 | Emigre Fonts

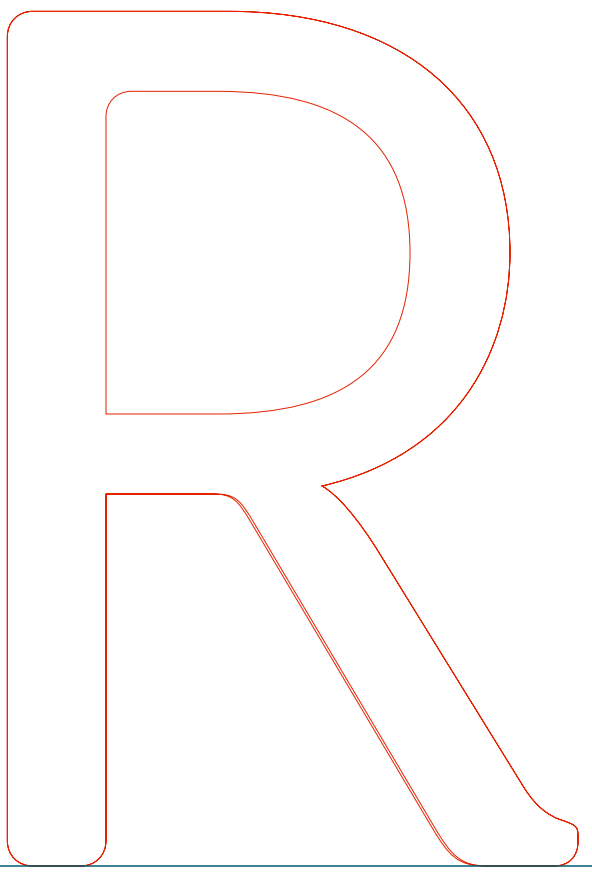
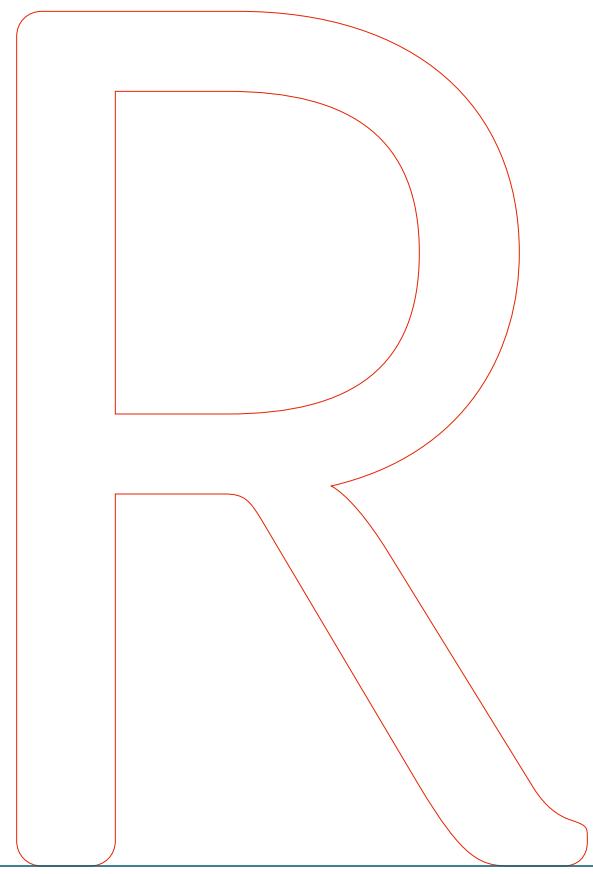
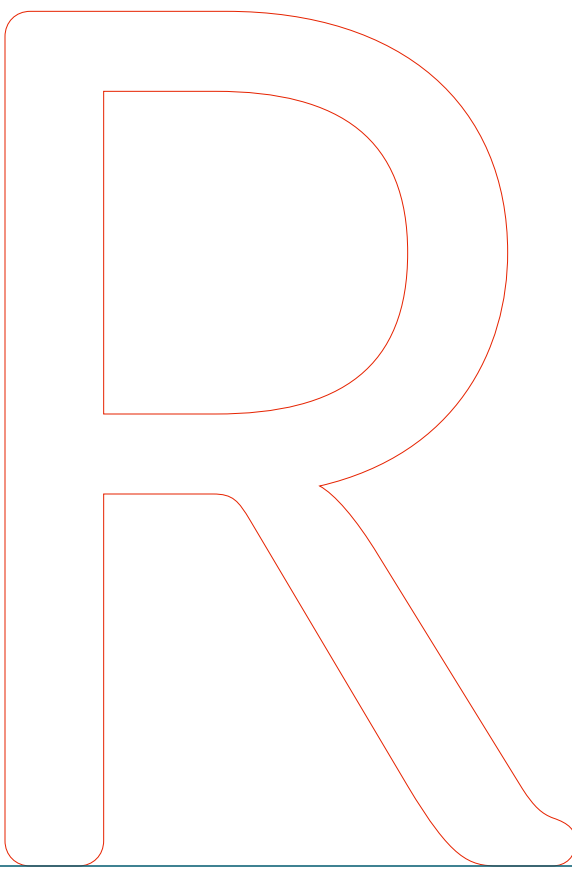
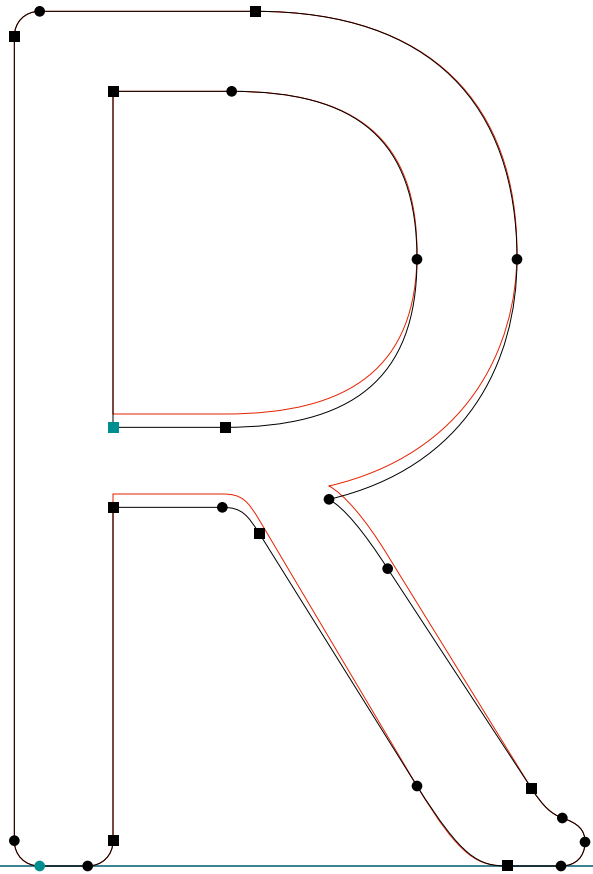

PROGRAM

.....
Program Book | S | RoboFog Sketches | 2013 | Emigre Fonts

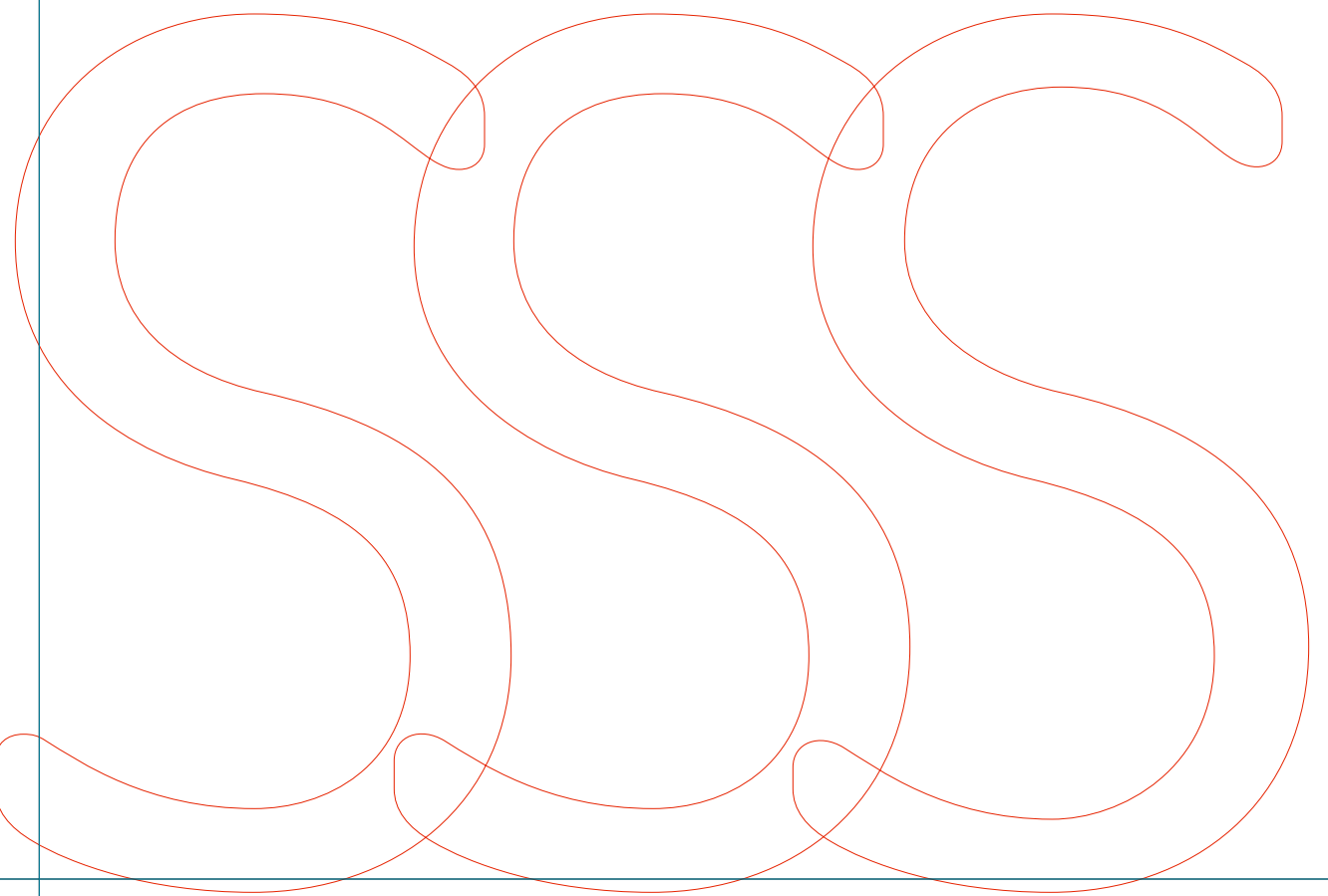
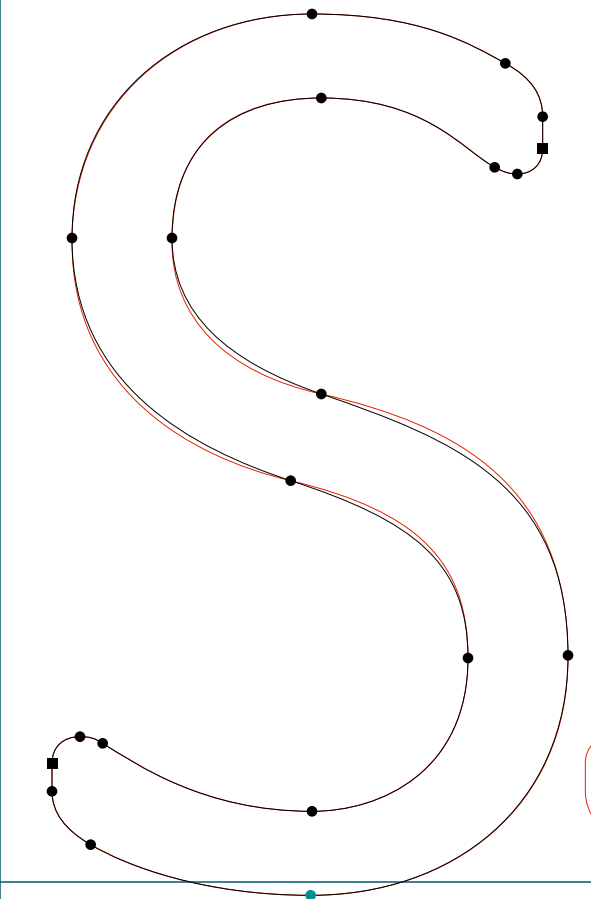
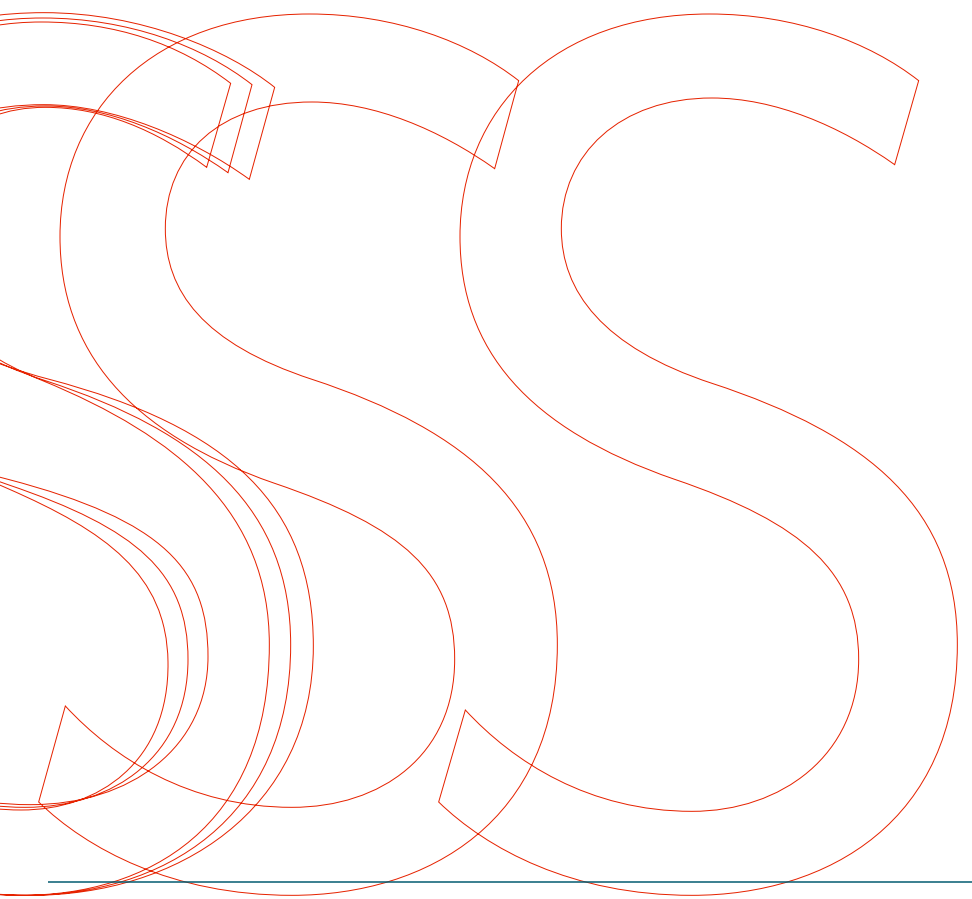

PROGRAM

.....
Program Book | W | RoboFog Sketches | 2013 | Emigre Fonts

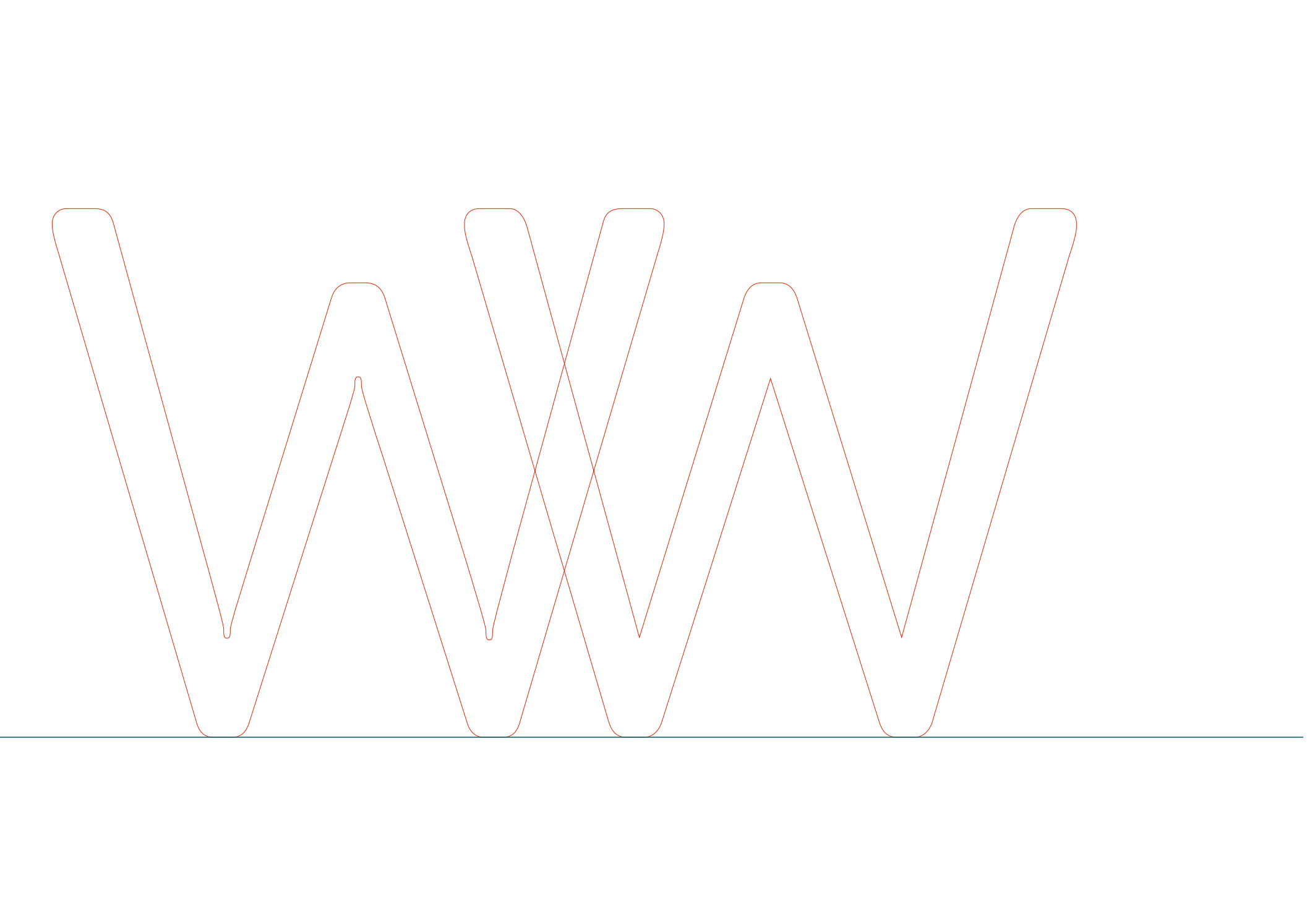
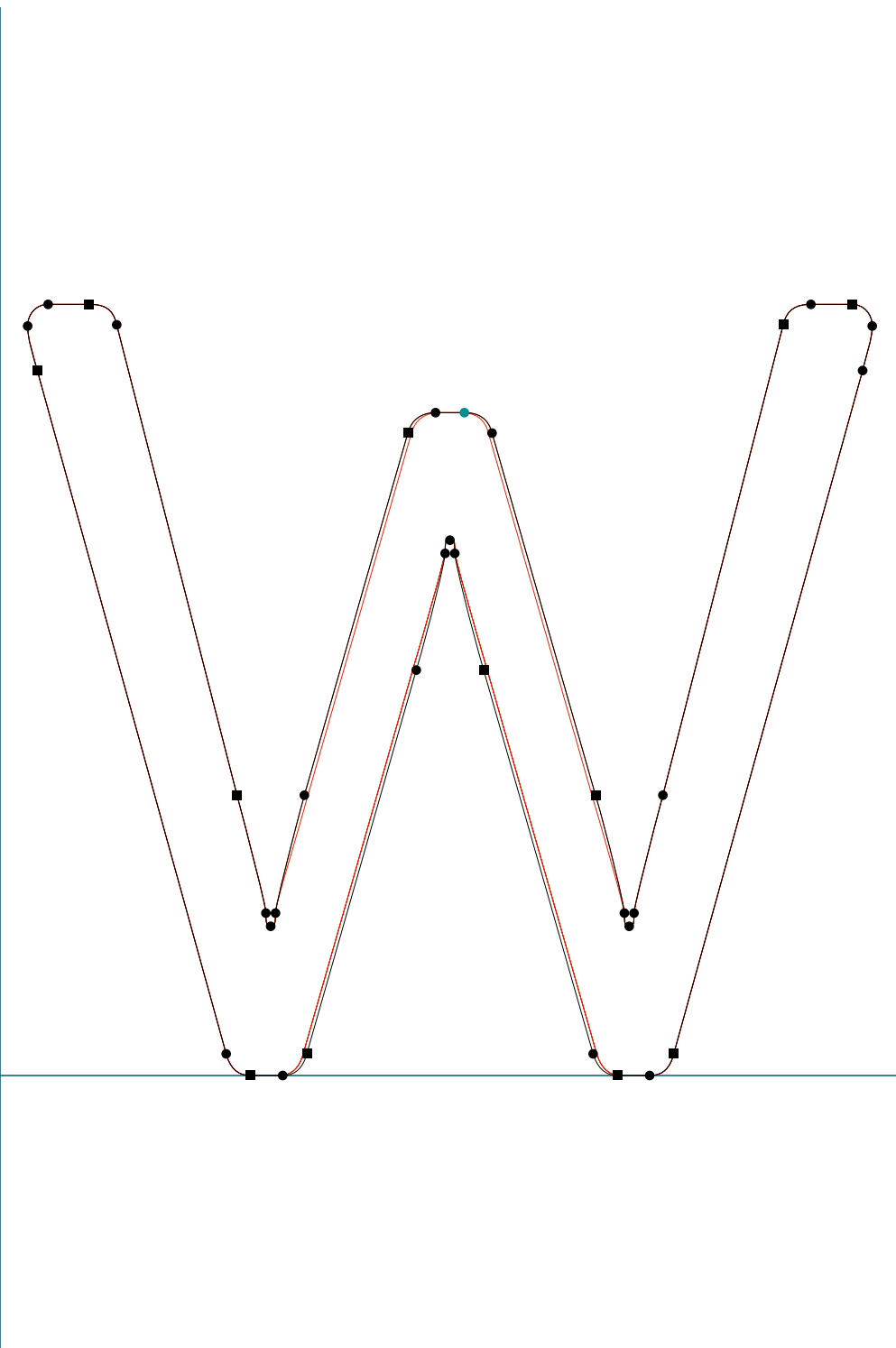

PROGRAM

.....
Program Book | X | RoboFog Sketches | 2013 | Emigre Fonts

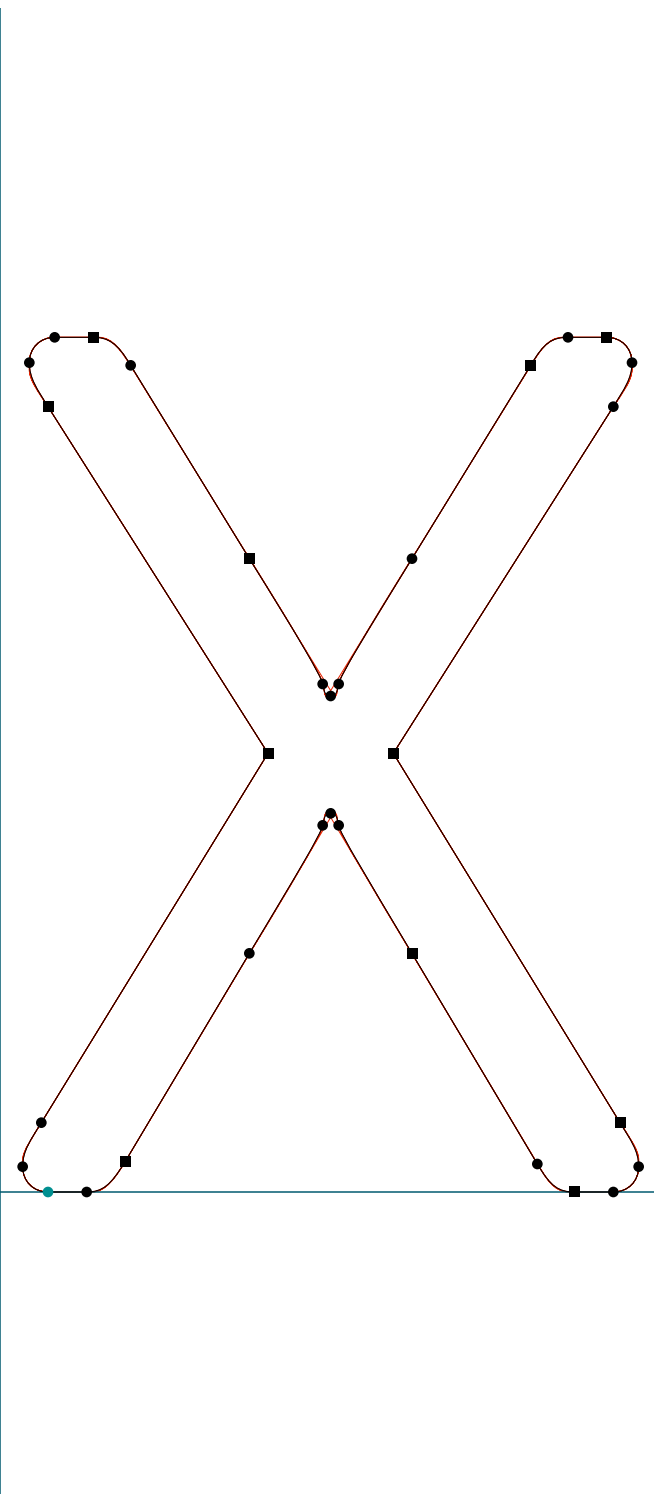

PROGRAM

.....
Program Book | asciiircum | RoboFog Sketches | 2013 | Emigre Fonts

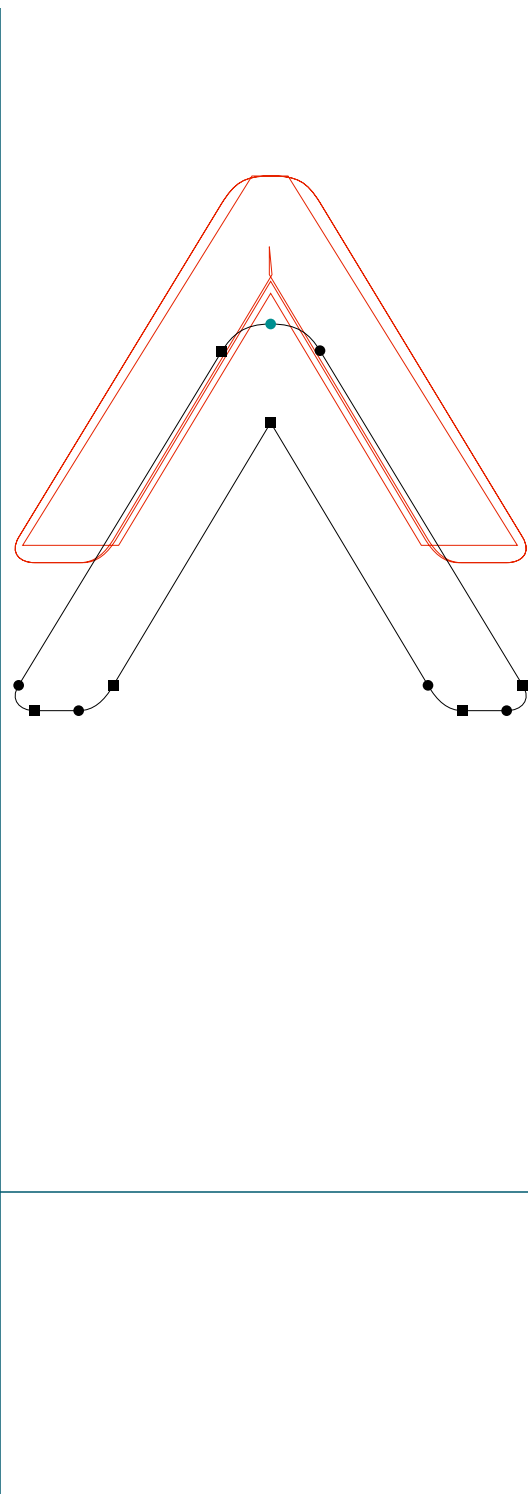

PROGRAM

.....
Program Book | a | RoboFog Sketches | 2013 | Emigre Fonts

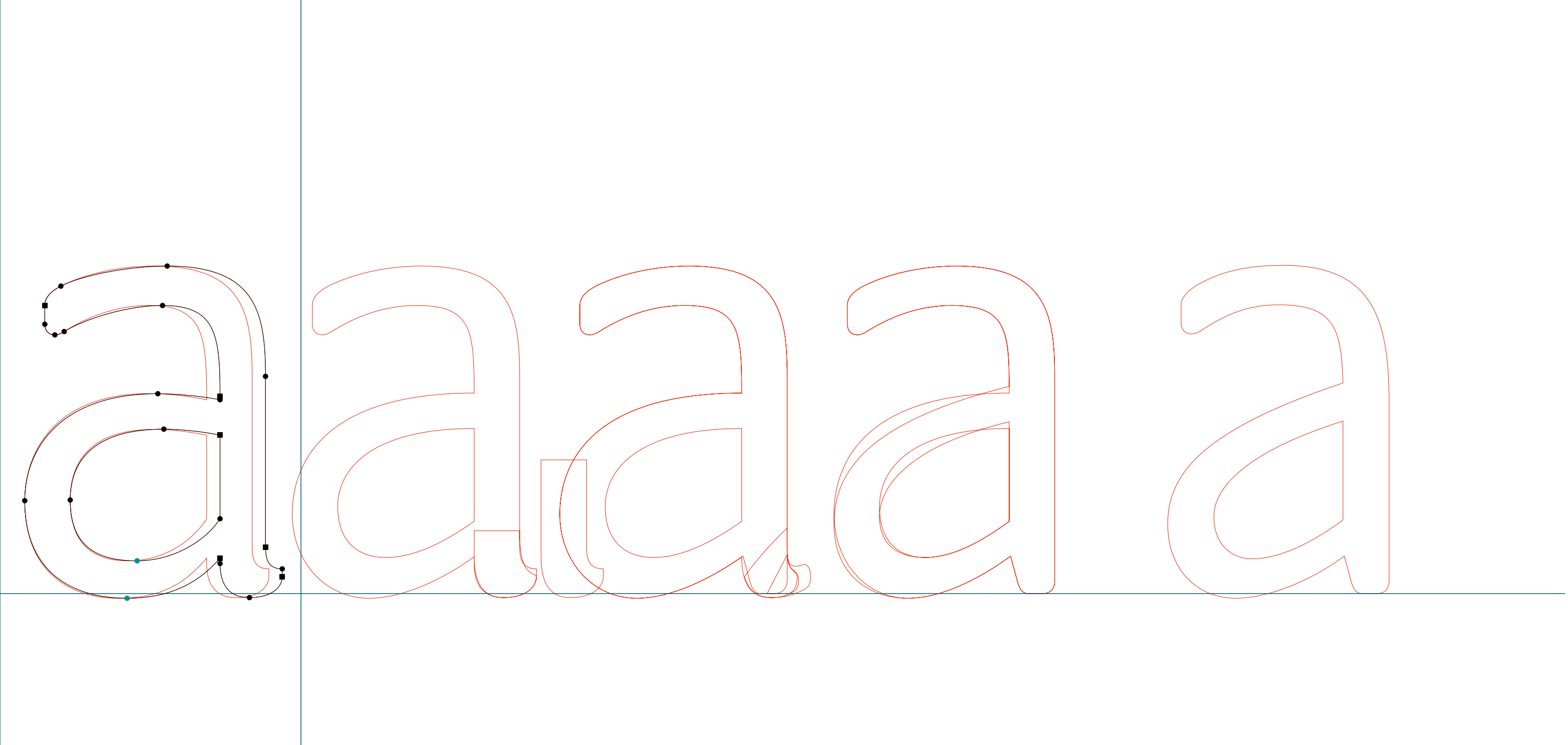

PROGRAM

.....
Program Book | b | RoboFog Sketches | 2013 | Emigre Fonts

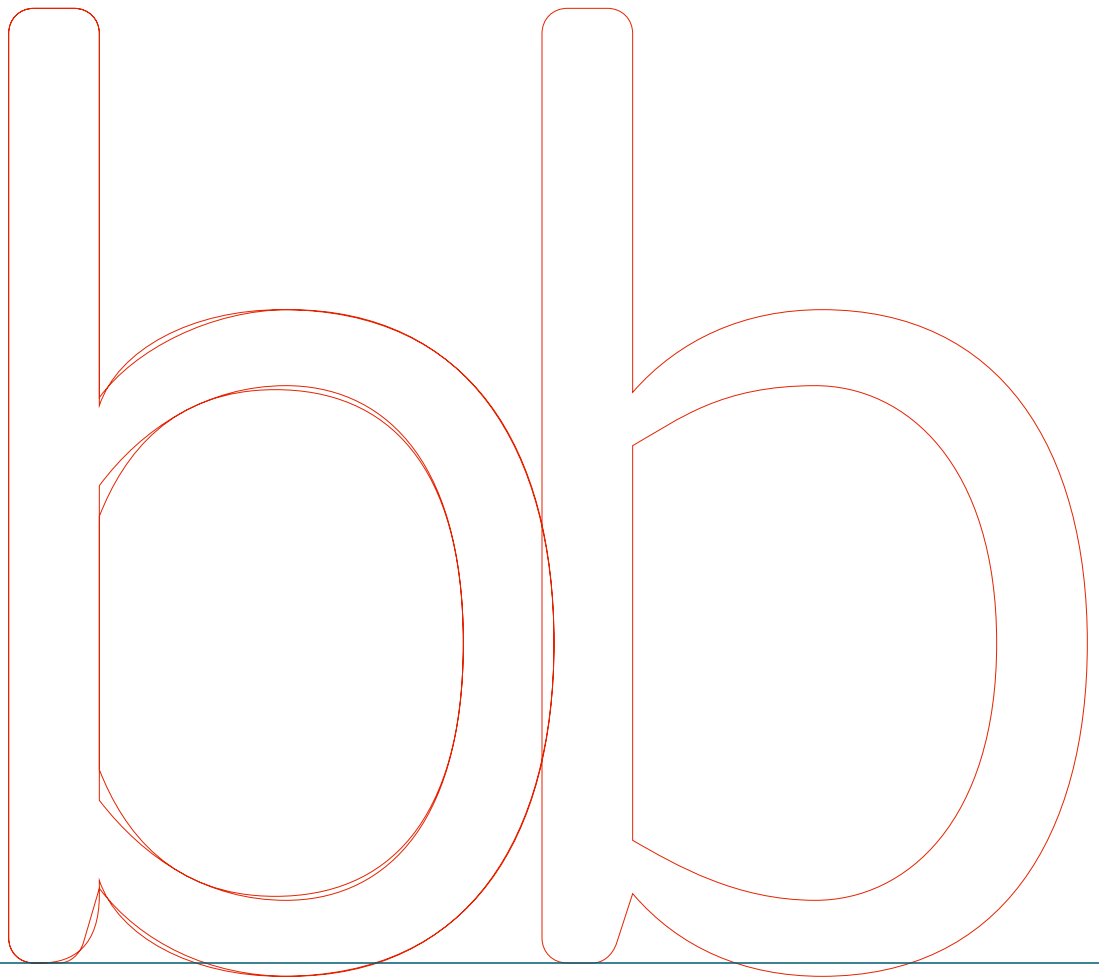
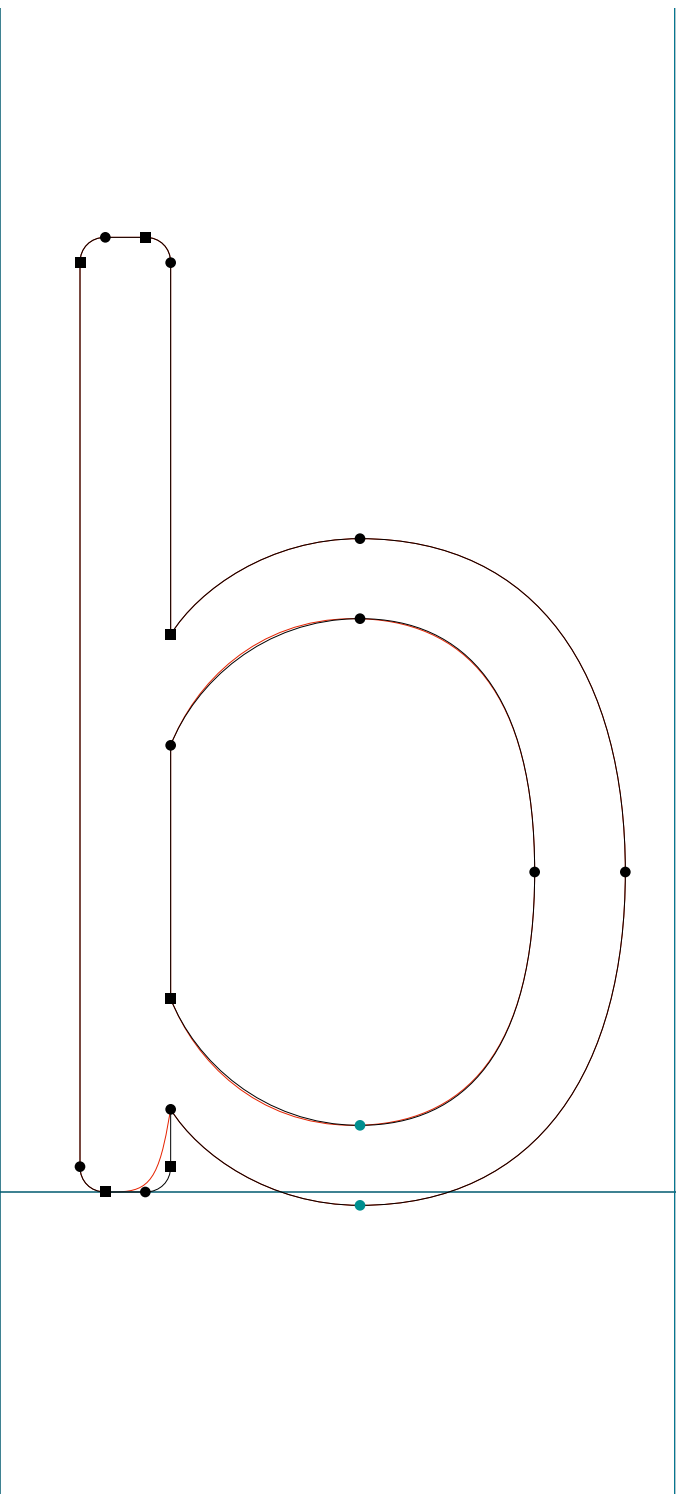

PROGRAM

.....
Program Book | c | RoboFog Sketches | 2013 | Emigre Fonts

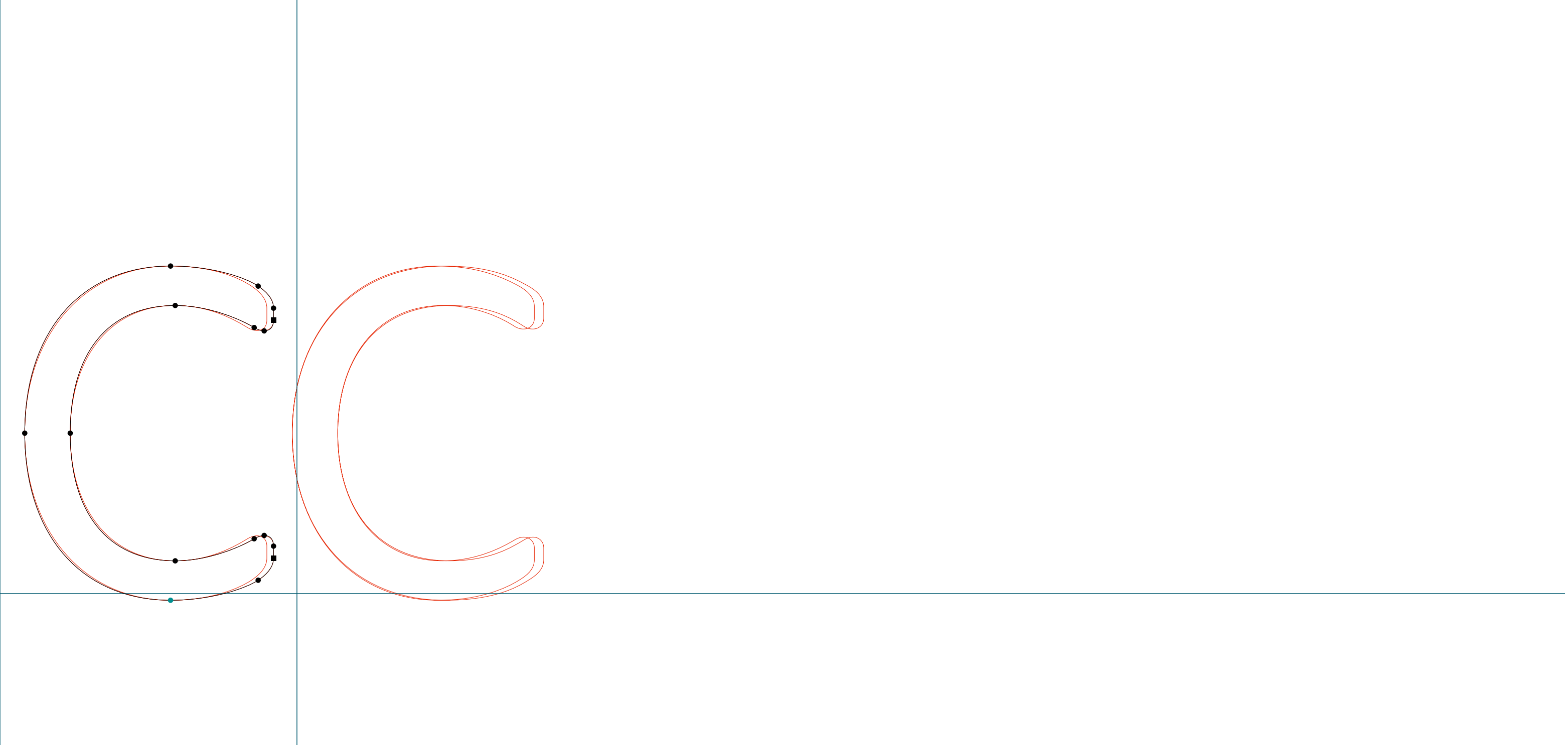

PROGRAM

.....
Program Book | d | RoboFog Sketches | 2013 | Emigre Fonts

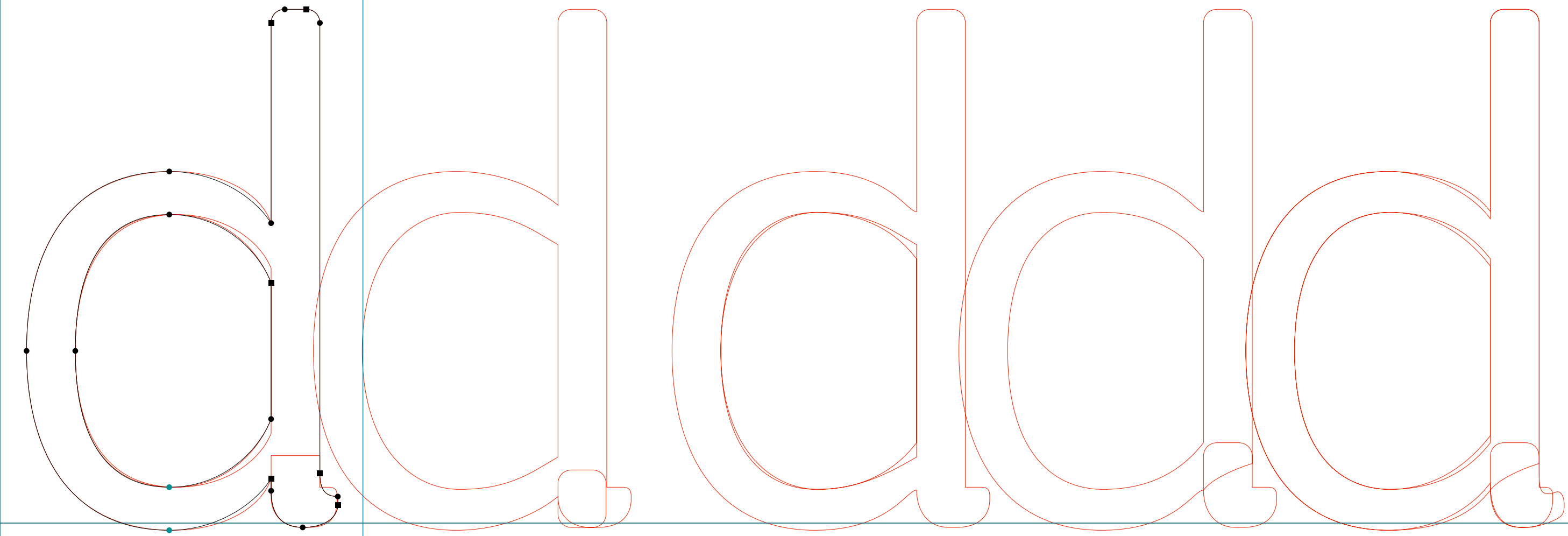

PROGRAM

.....
Program Book | f | RoboFog Sketches | 2013 | Emigre Fonts

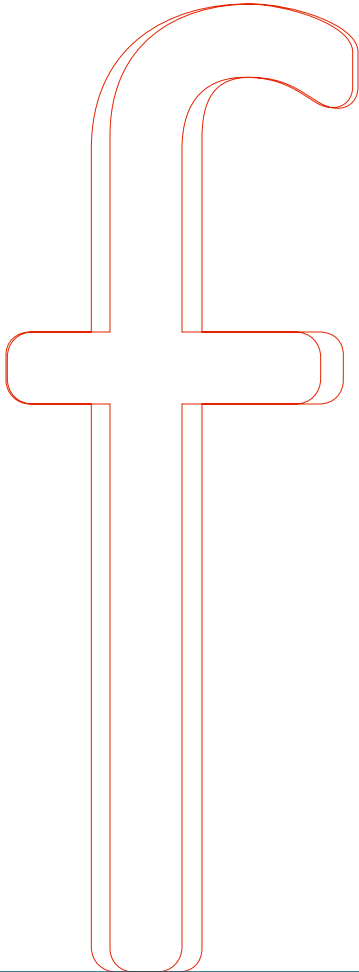
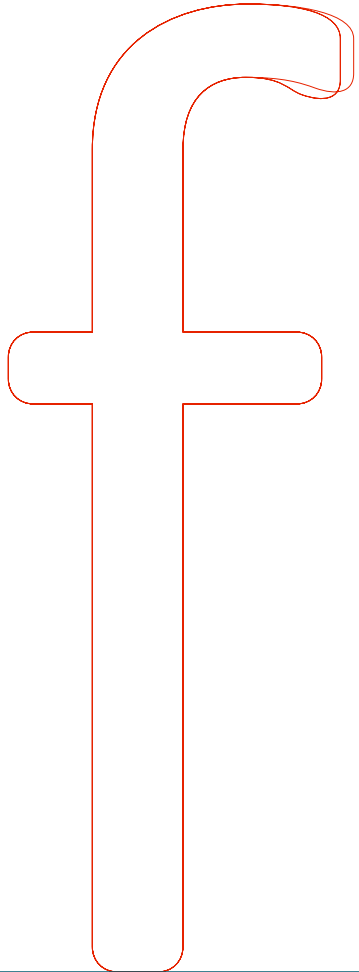
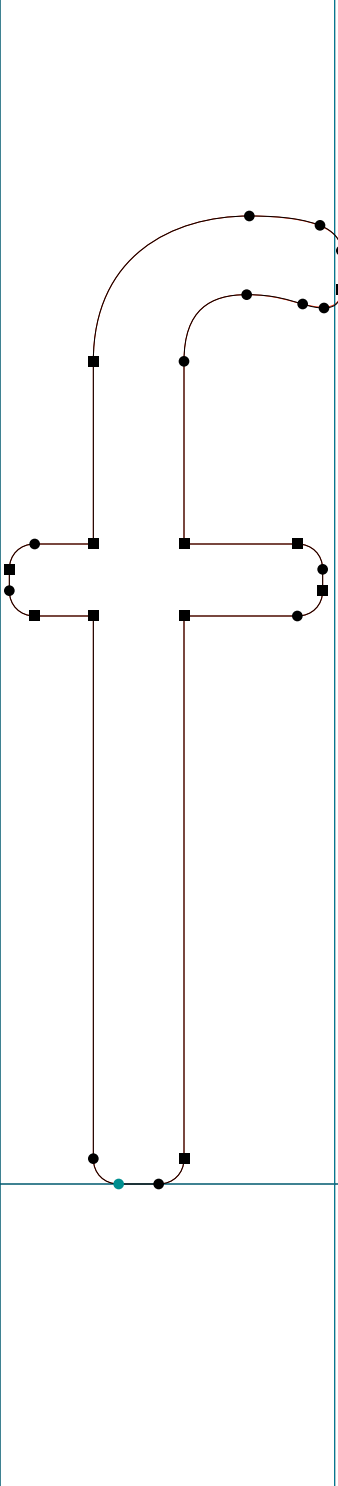

PROGRAM

.....
Program Book | g | RoboFog Sketches | 2013 | Emigre Fonts

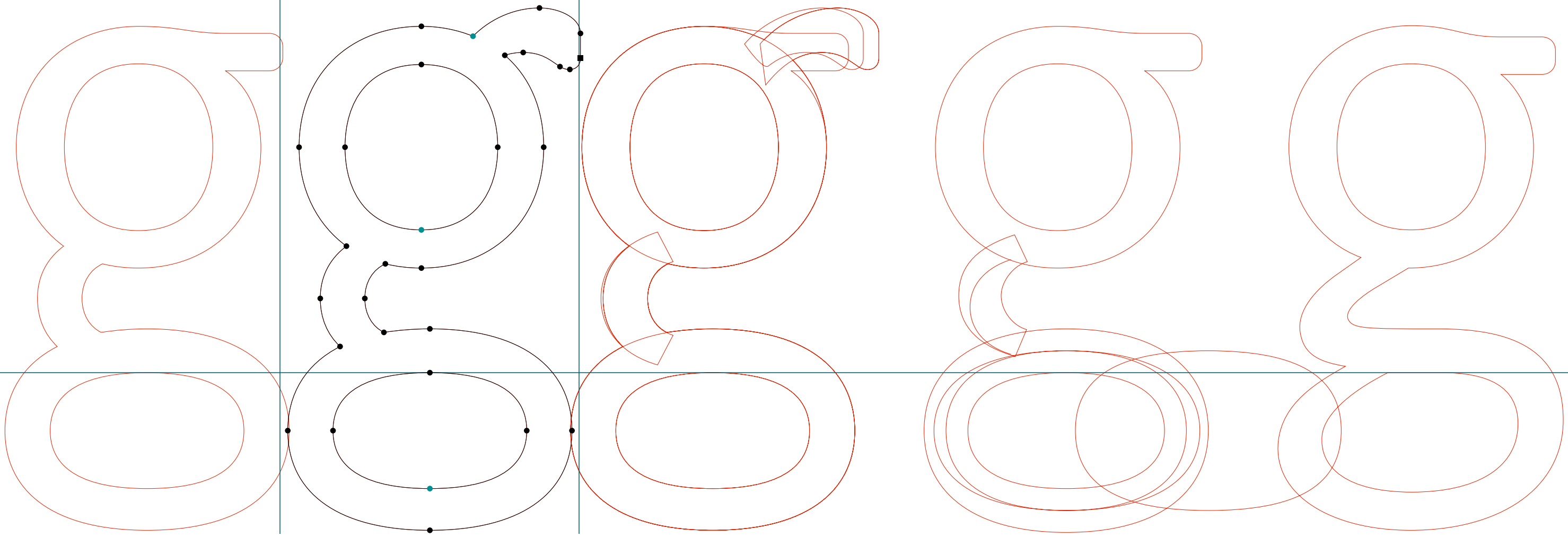

PROGRAM

.....
Program Book | h | RoboFog Sketches | 2013 | Emigre Fonts

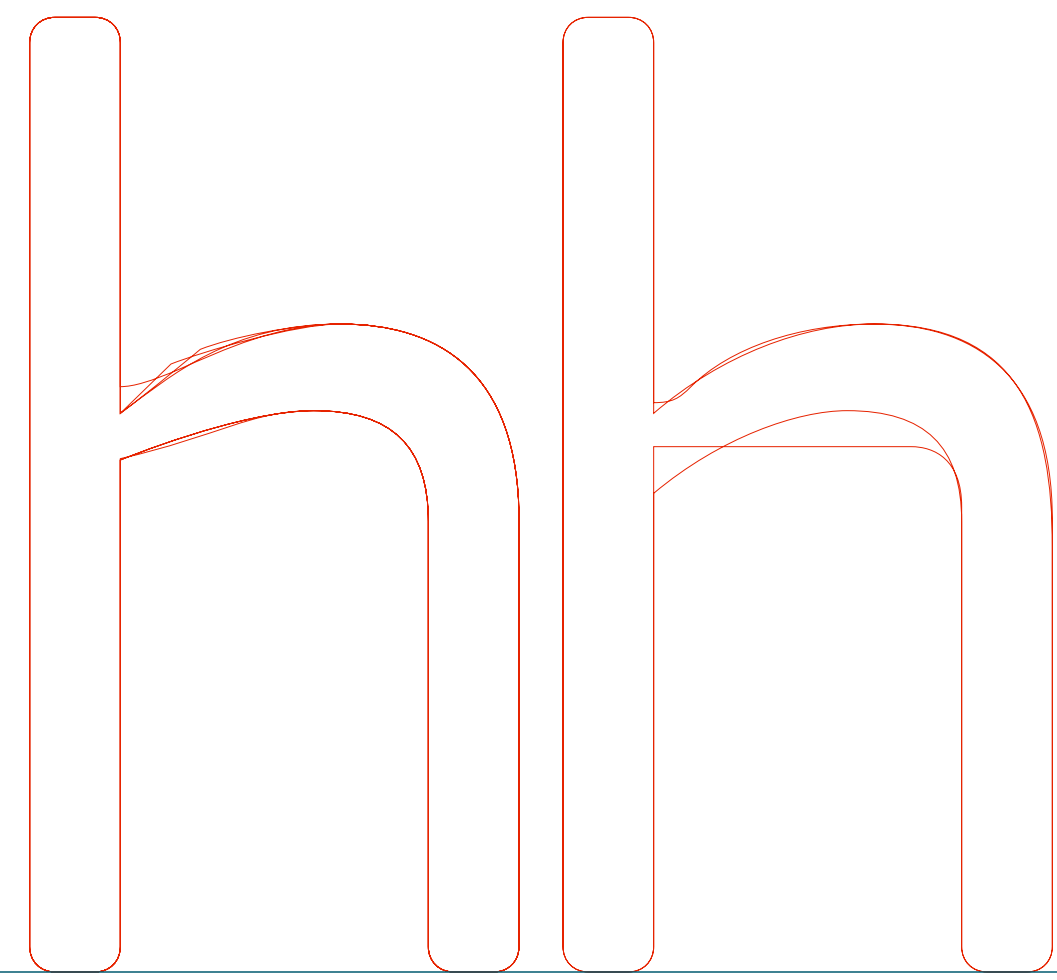
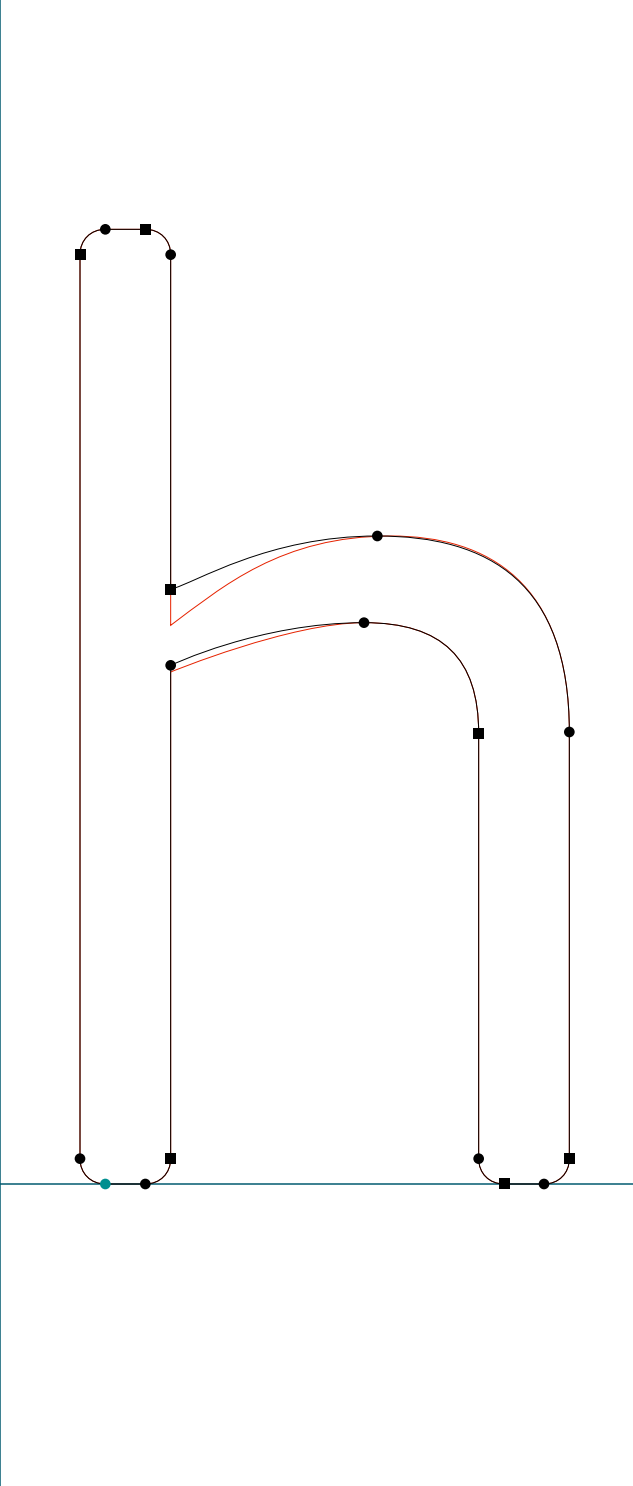

PROGRAM

.....
Program Book | i | RoboFog Sketches | 2013 | Emigre Fonts

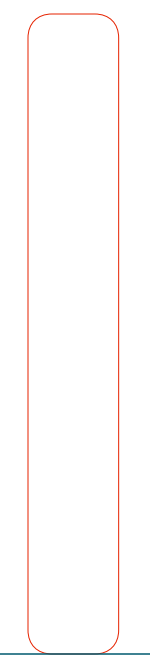
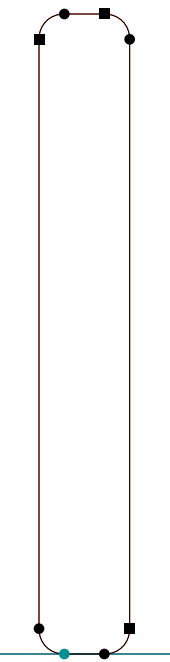
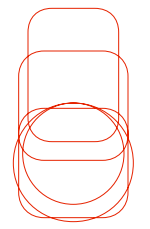
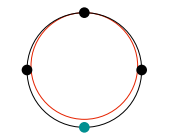

PROGRAM

.....
Program Book | j | RoboFog Sketches | 2013 | Emigre Fonts

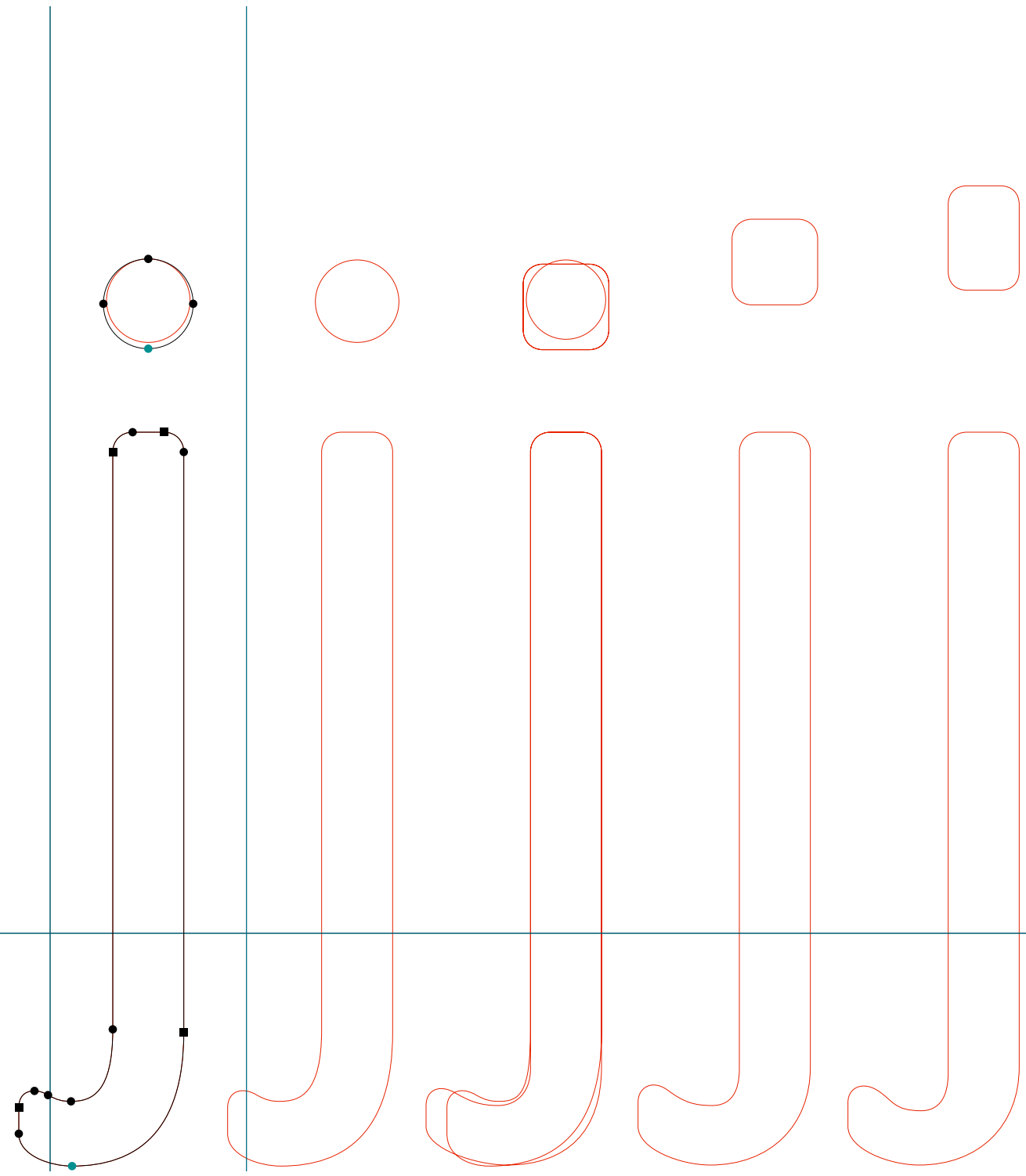

PROGRAM

.....
Program Book | I | RoboFog Sketches | 2013 | Emigre Fonts

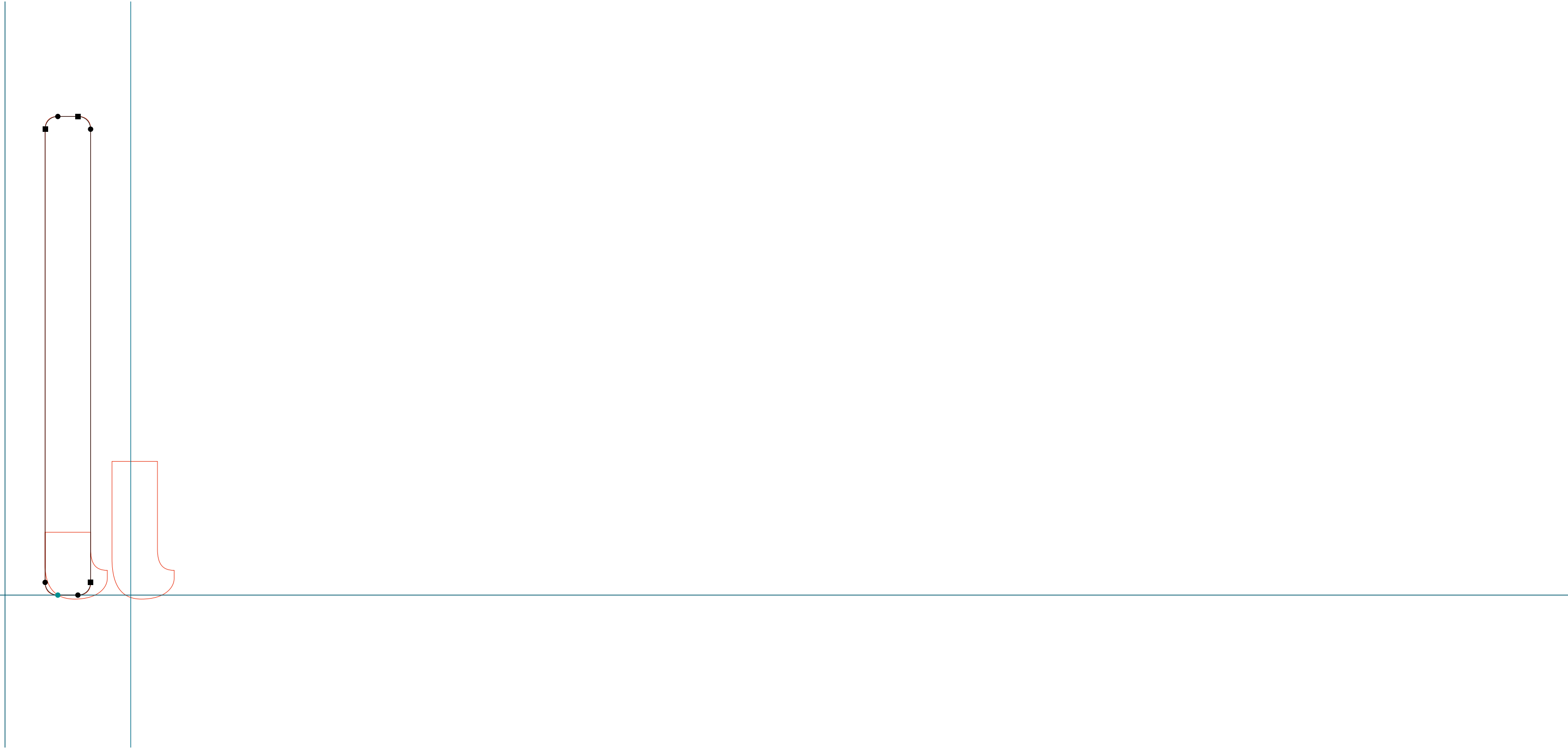

PROGRAM

.....
Program Book | m | RoboFog Sketches | 2013 | Emigre Fonts

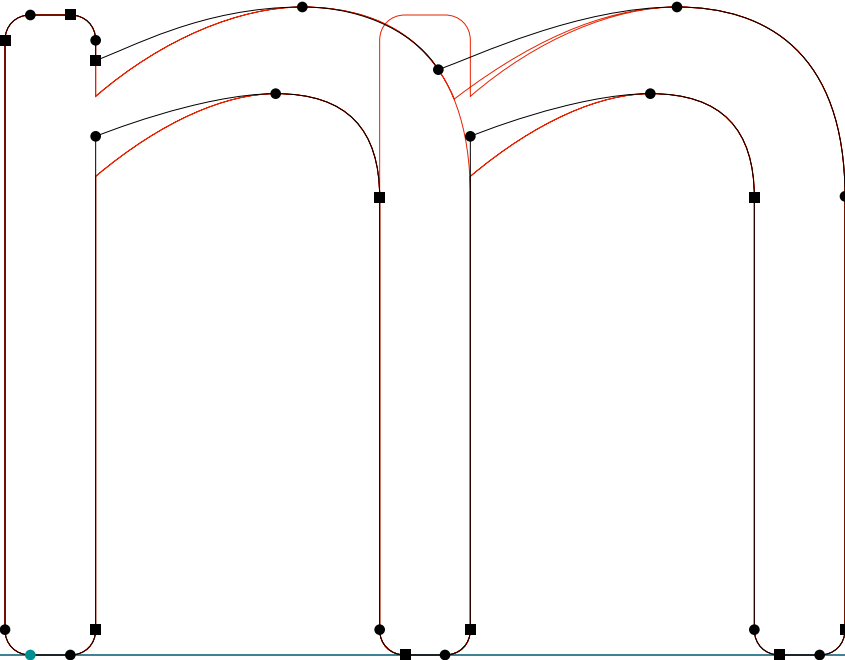

PROGRAM

.....
Program Book | n | RoboFog Sketches | 2013 | Emigre Fonts

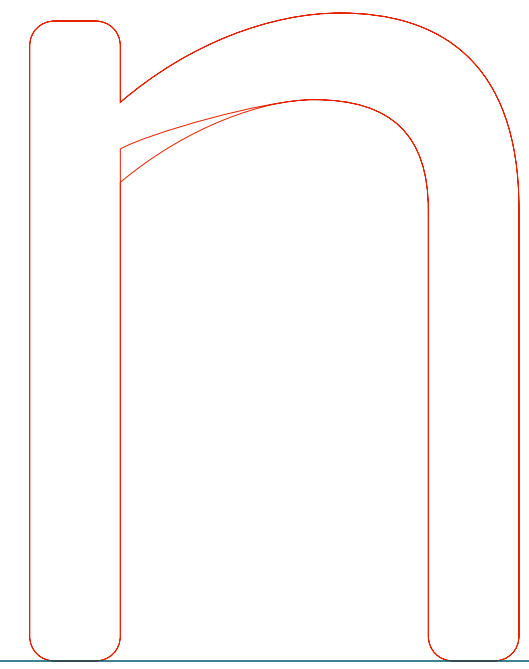
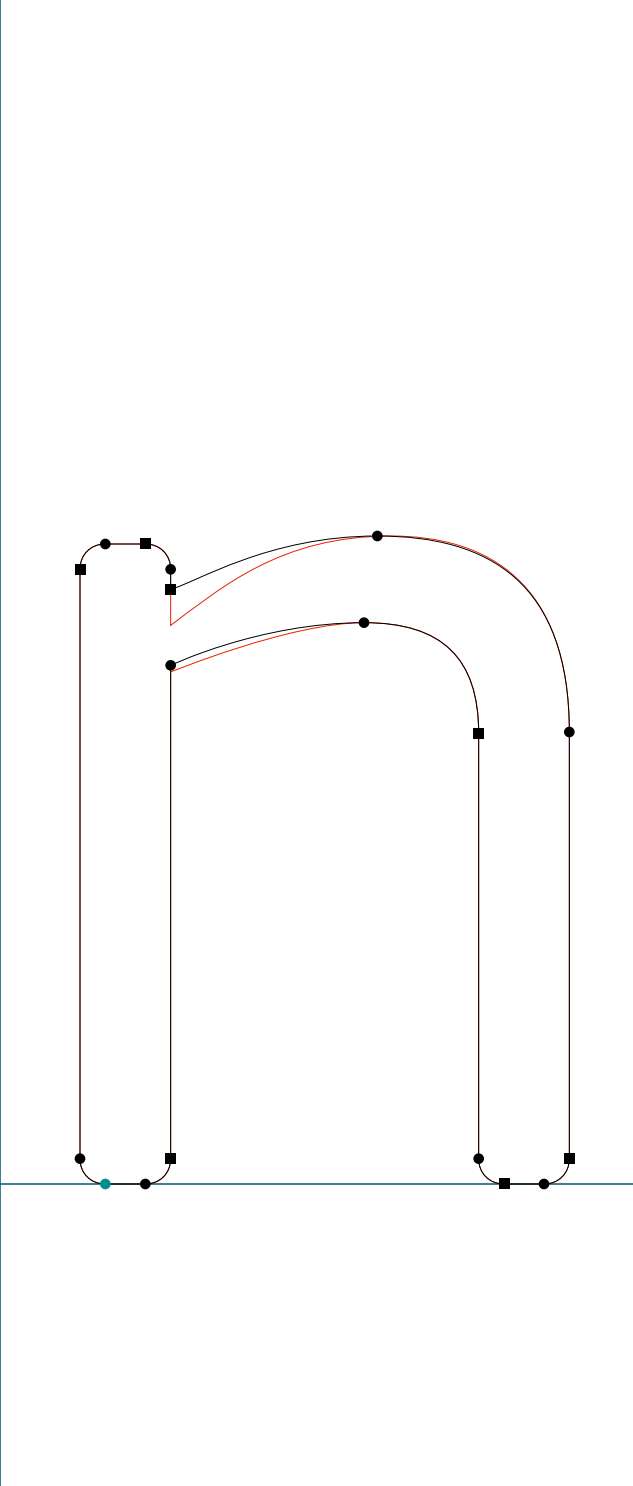

PROGRAM

.....
Program Book | t | RoboFog Sketches | 2013 | Emigre Fonts

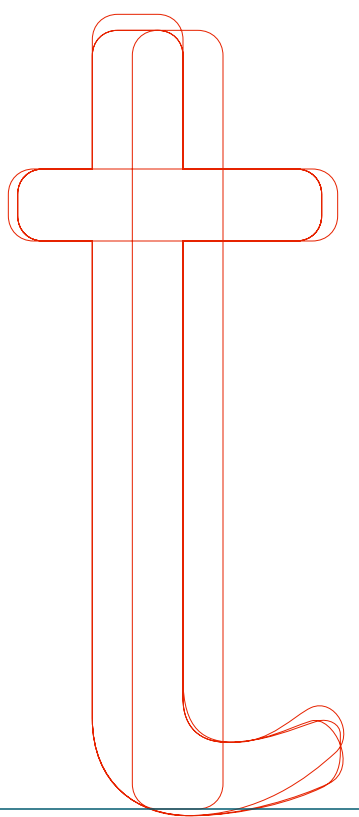
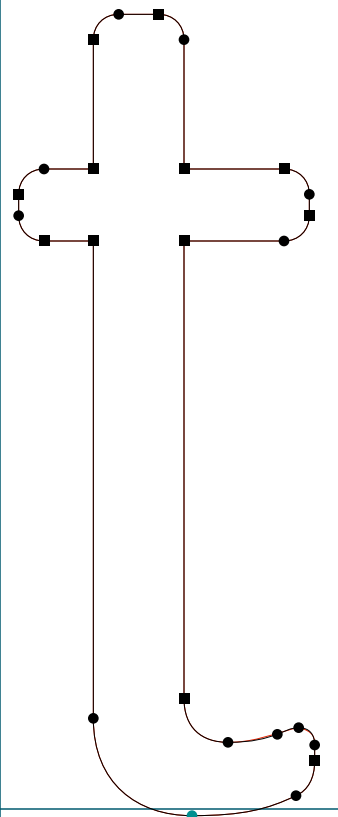

PROGRAM

.....
Program Book | u | RoboFog Sketches | 2013 | Emigre Fonts

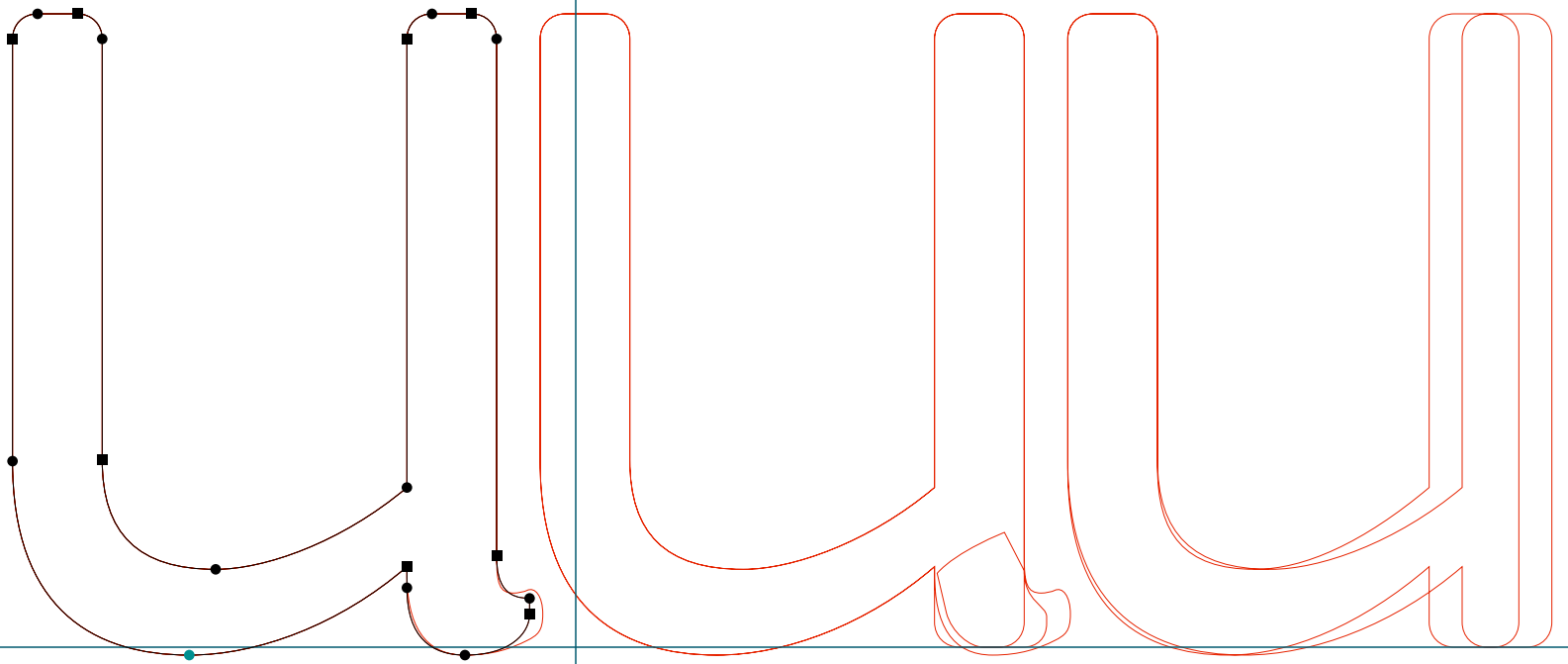

PROGRAM

.....
Program Book | v | RoboFog Sketches | 2013 | Emigre Fonts

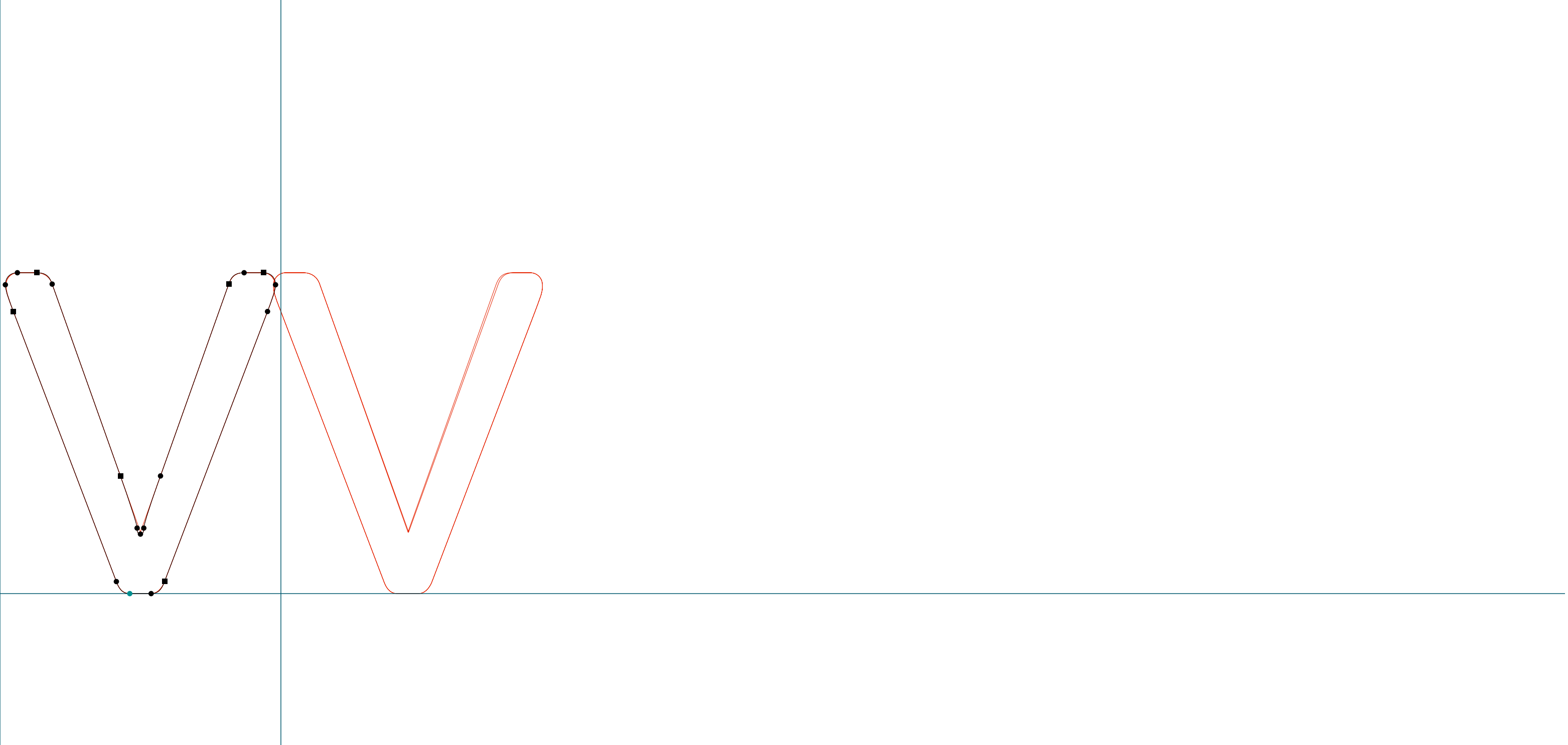

PROGRAM

.....
Program Book | w | RoboFog Sketches | 2013 | Emigre Fonts

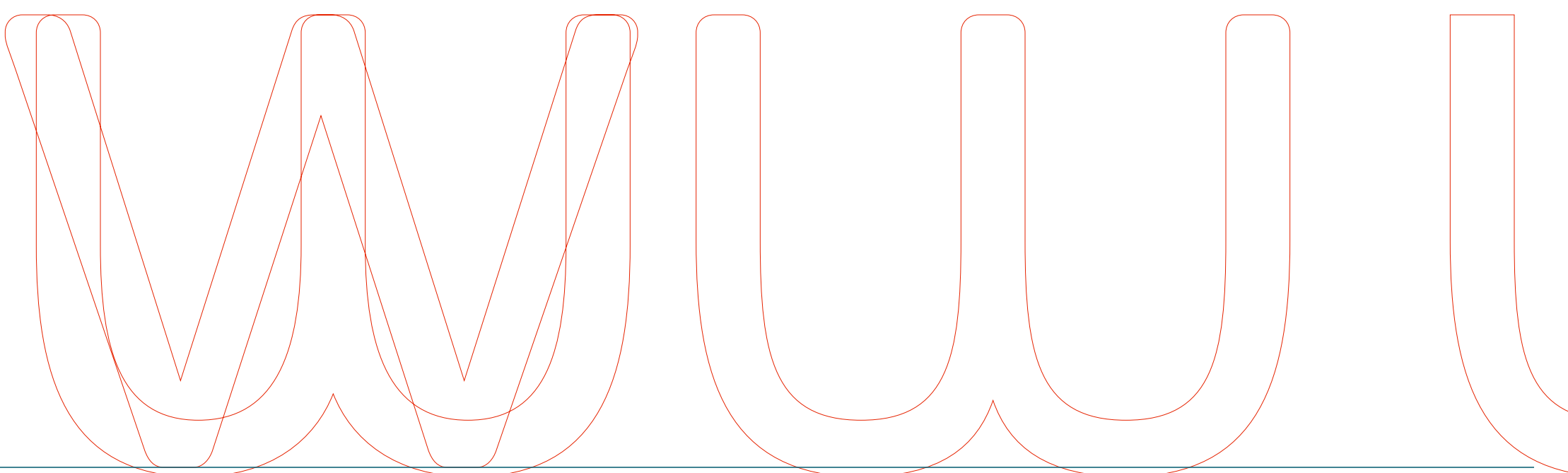
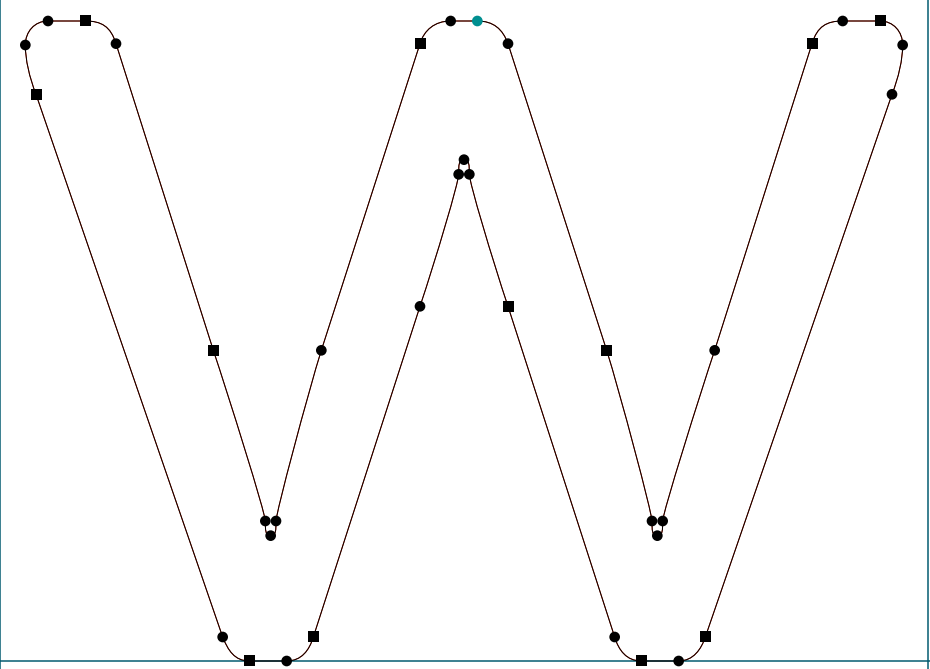

PROGRAM

.....
Program Book | y | RoboFog Sketches | 2013 | Emigre Fonts

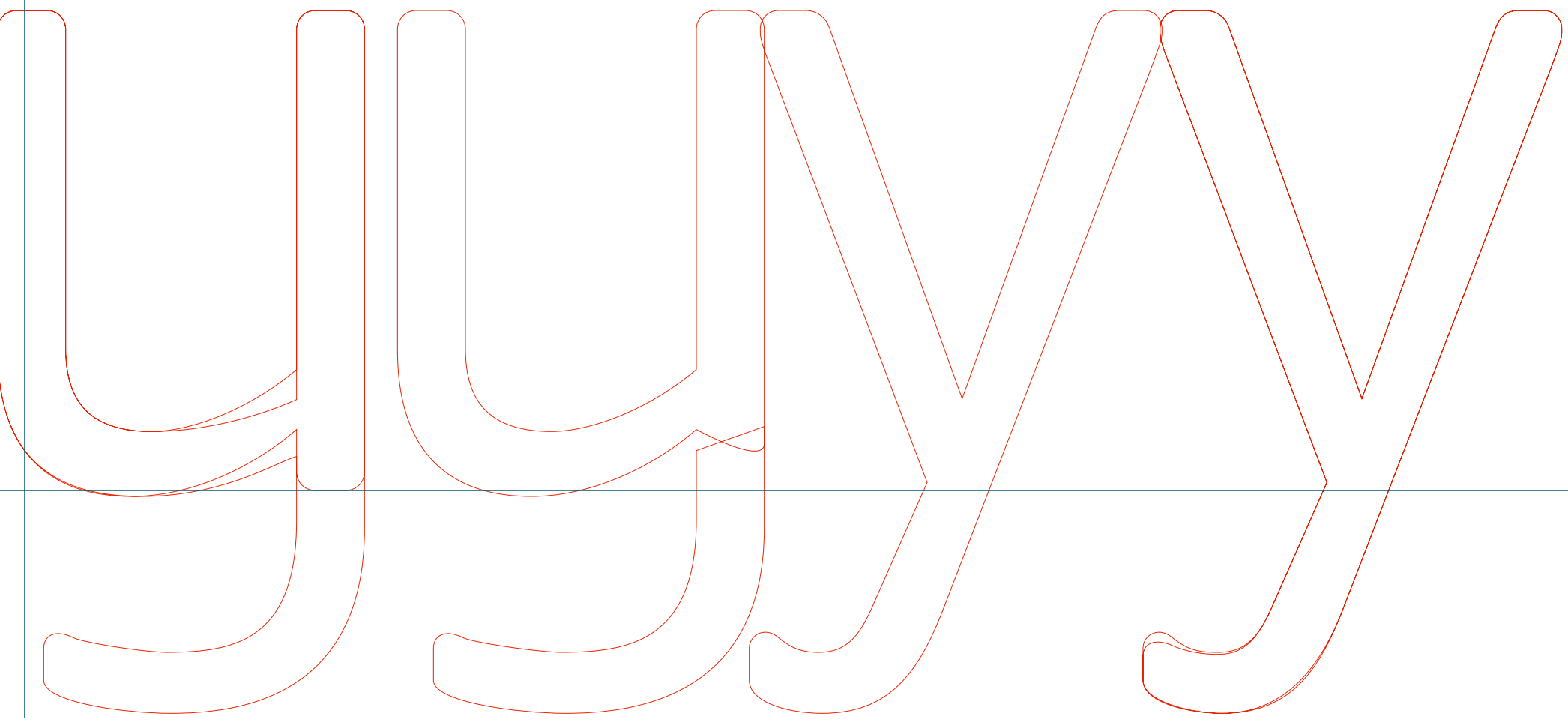
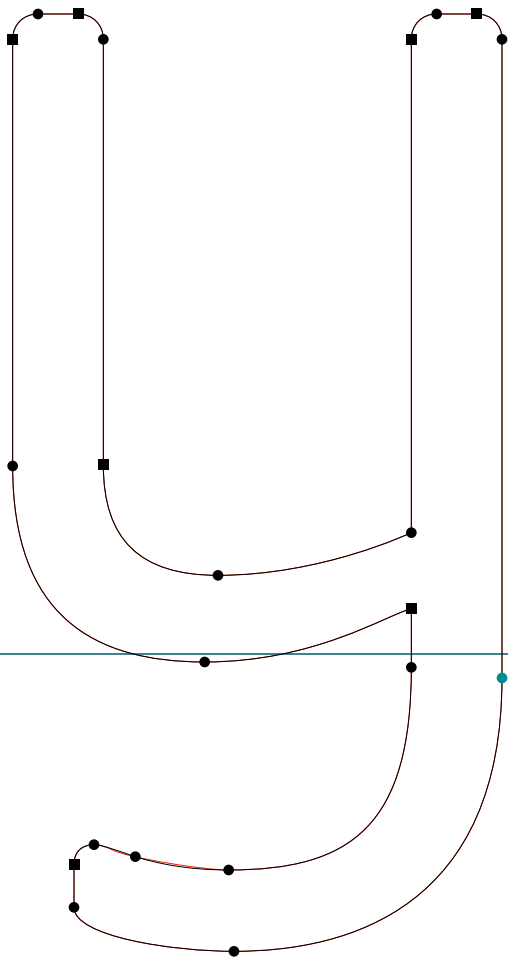

PROGRAM

.....
Program Book | cent | RoboFog Sketches | 2013 | Emigre Fonts

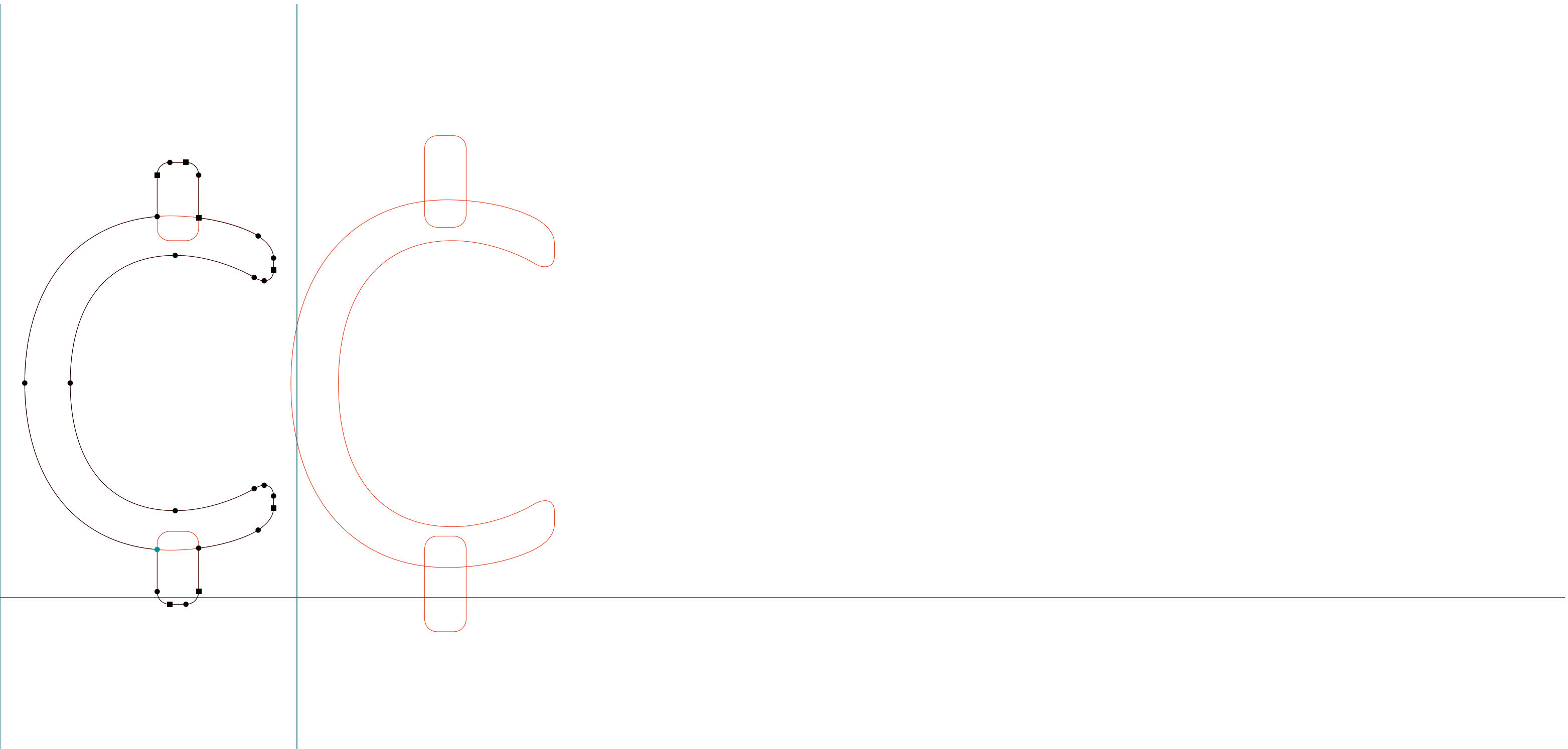

PROGRAM

.....
Program Book | sterling | RoboFog Sketches | 2013 | Emigre Fonts

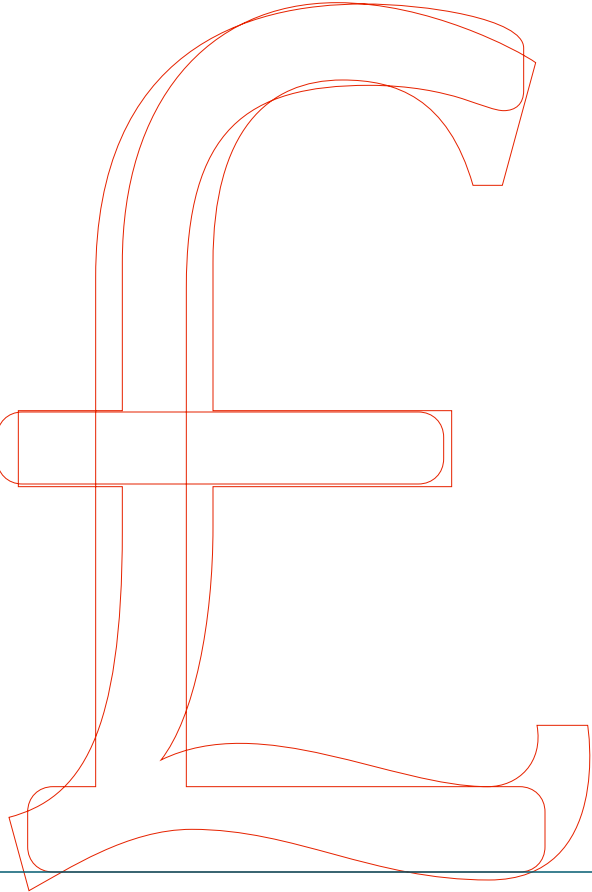
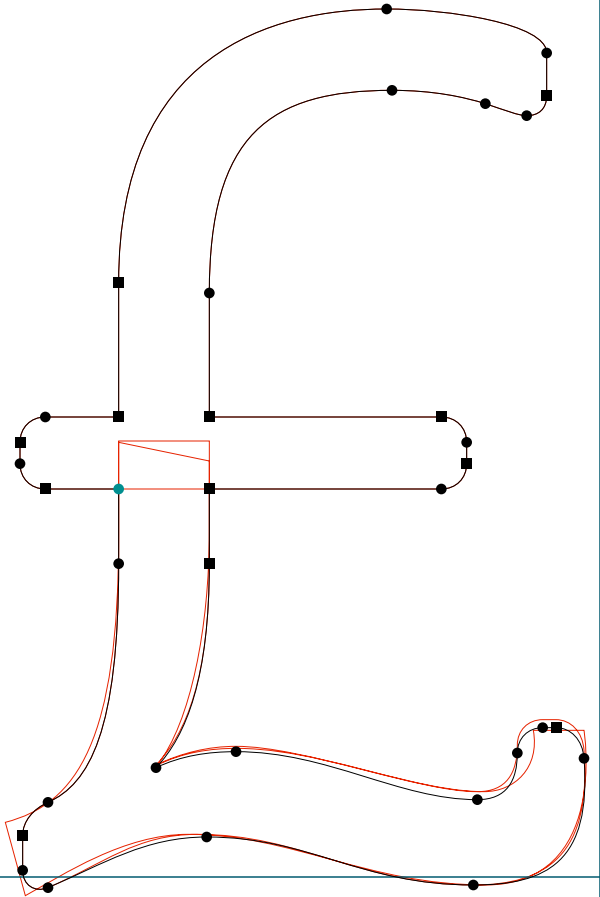
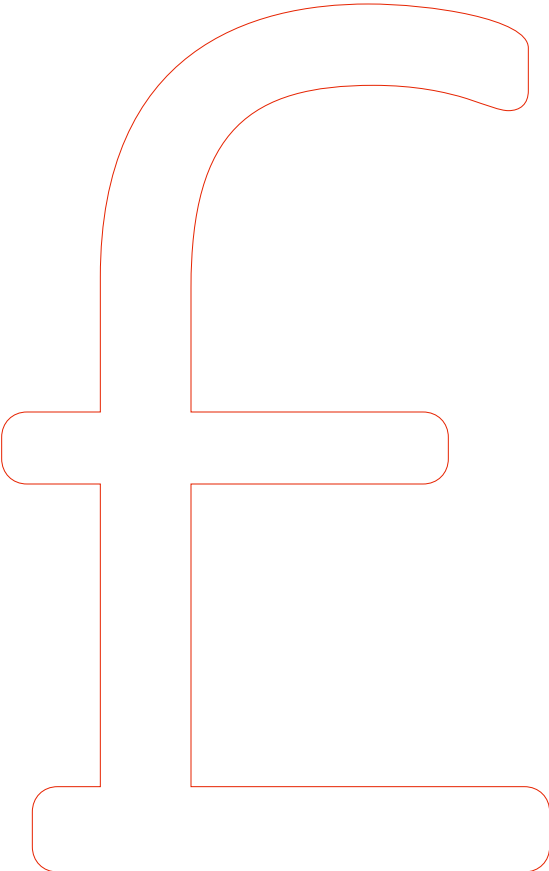

PROGRAM

Program Book | summation | RoboFog Sketches | 2013 | Emigre Fonts

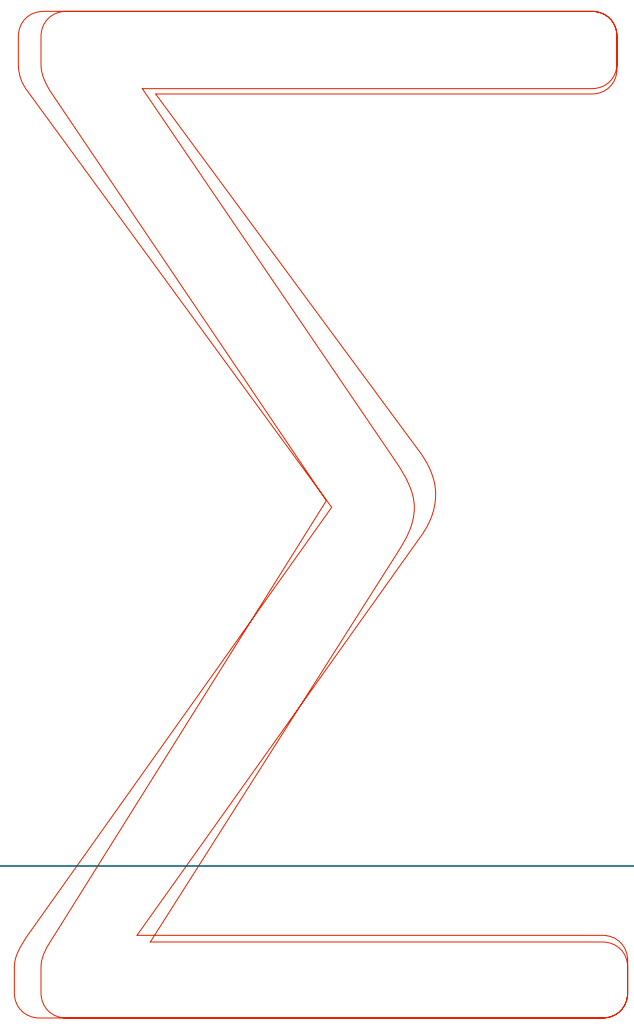
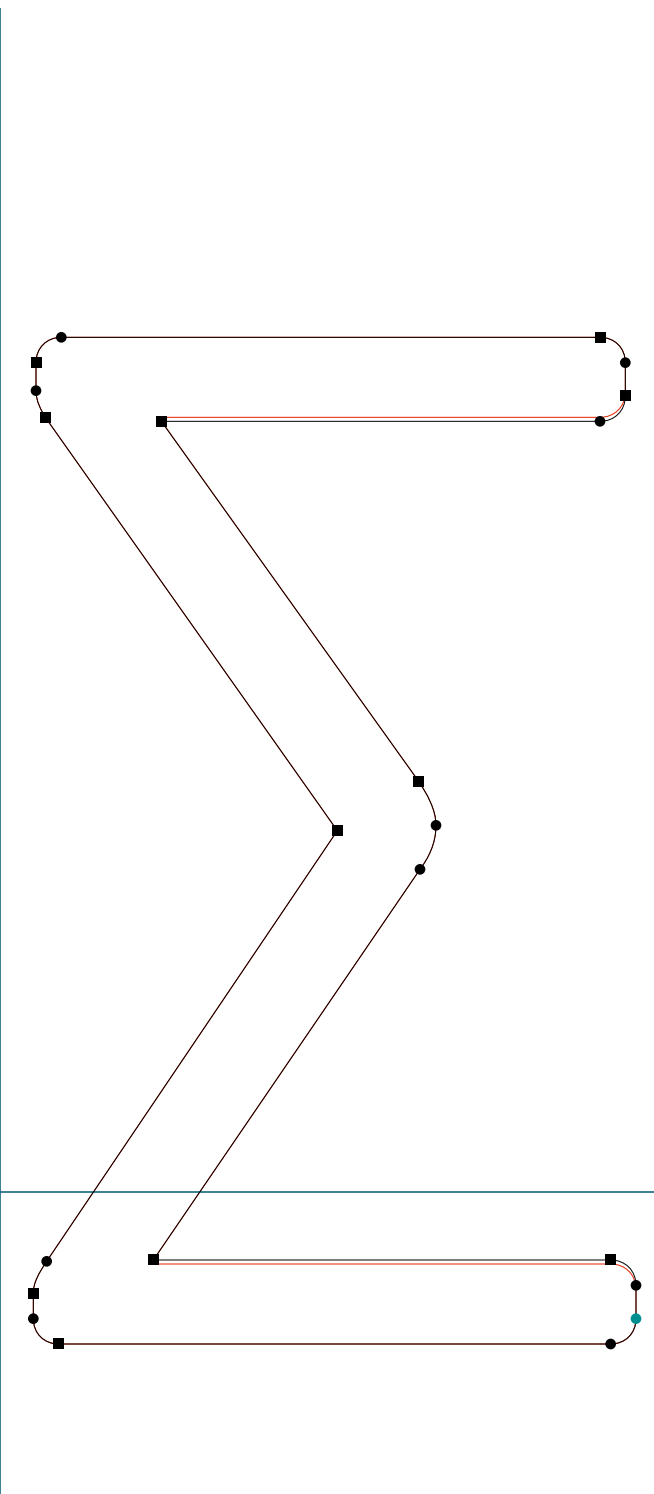

PROGRAM

.....
Program Book | Omega | RoboFog Sketches | 2013 | Emigre Fonts

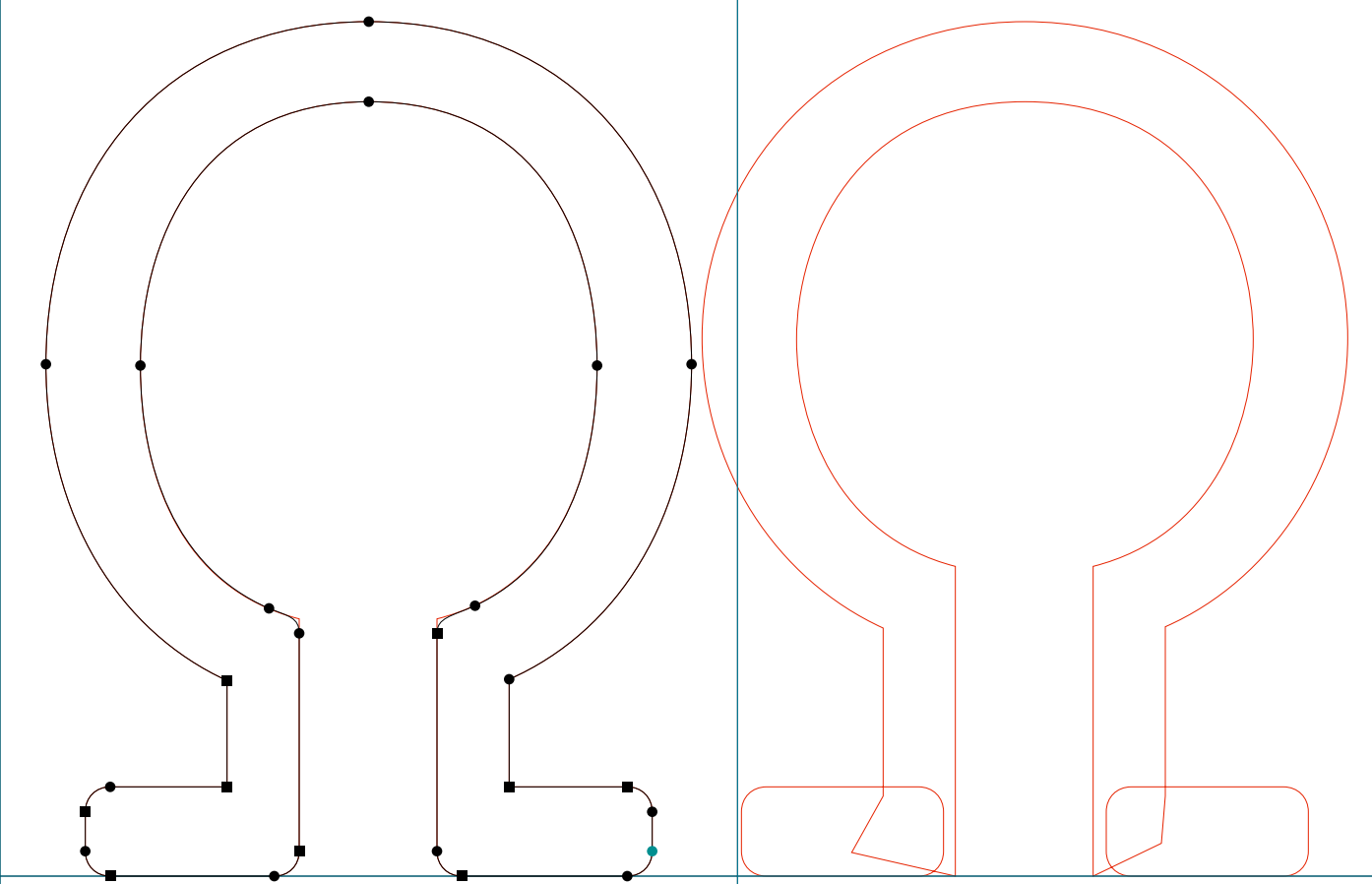

PROGRAM

.....
Program Book | approxequal | RoboFog Sketches | 2013 | Emigre Fonts

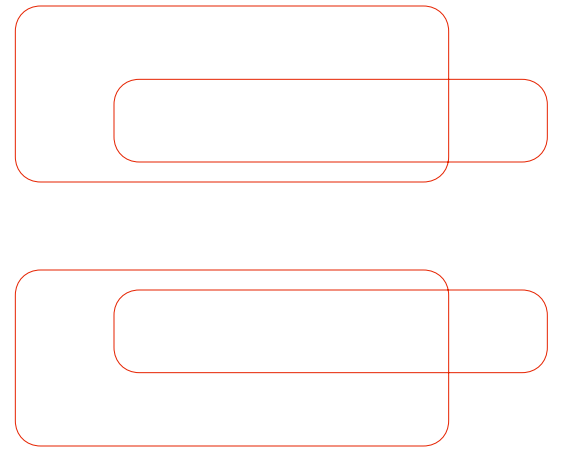
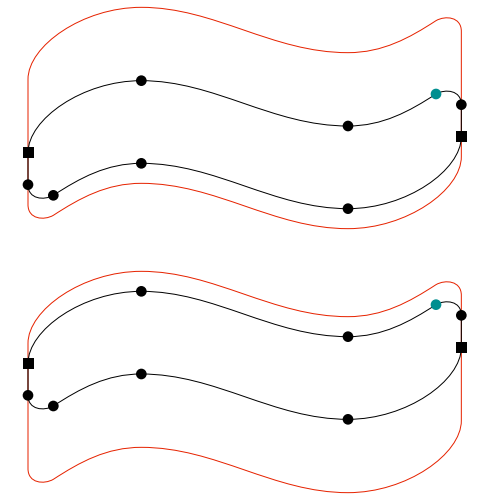

PROGRAM

.....
Program Book | Delta | RoboFog Sketches | 2013 | Emigre Fonts

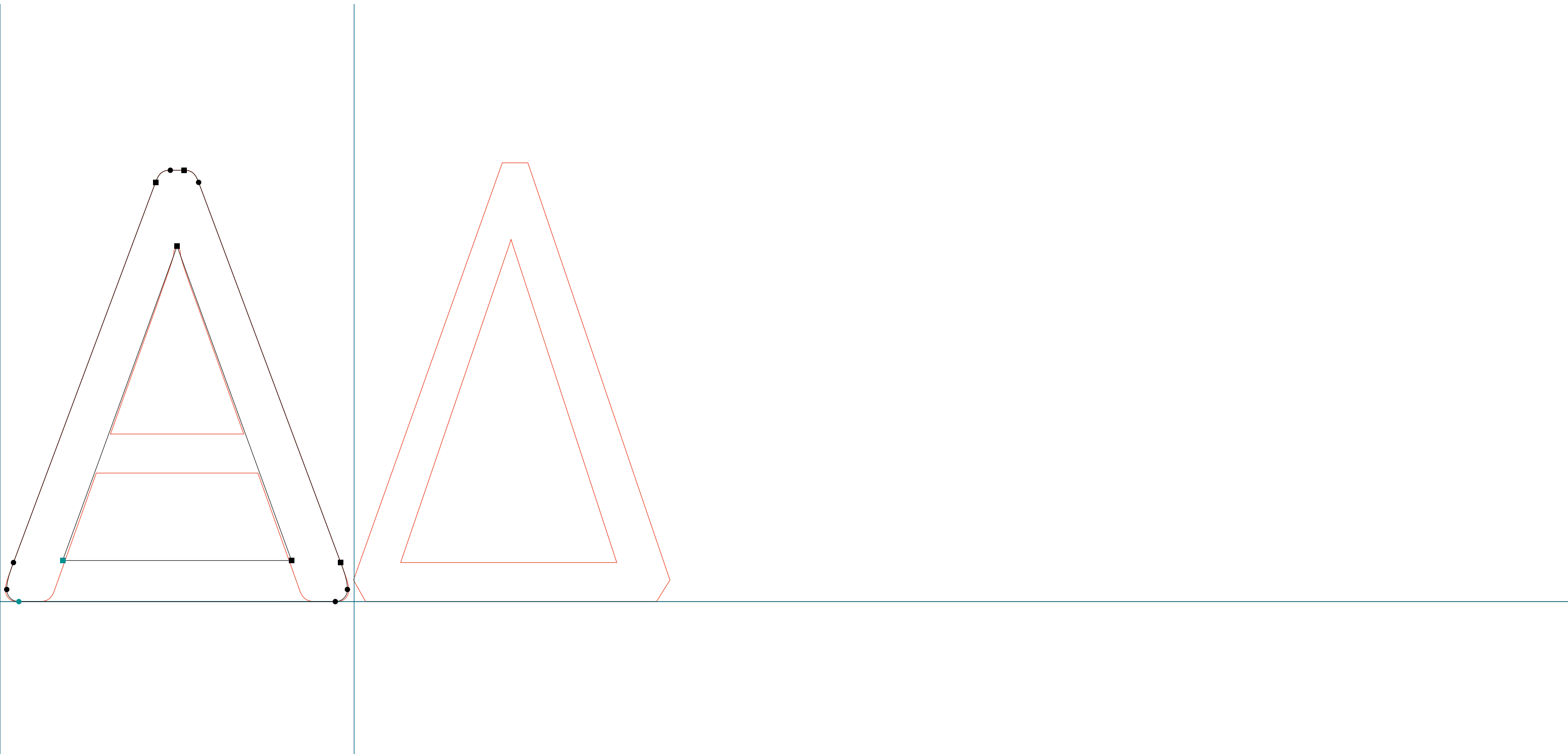

PROGRAM

.....
Program Book | circumflex | RoboFog Sketches | 2013 | Emigre Fonts

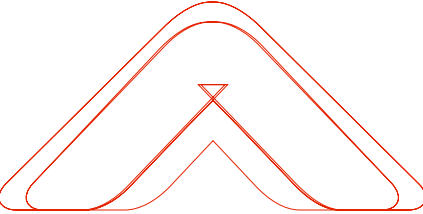
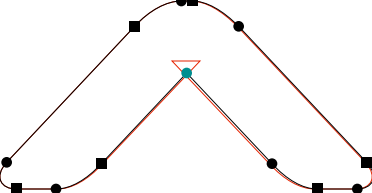
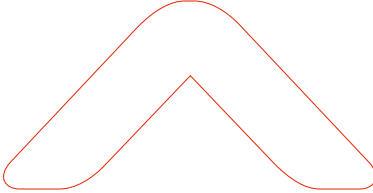

PROGRAM

.....
Program Book | tilde | RoboFog Sketches | 2013 | Emigre Fonts

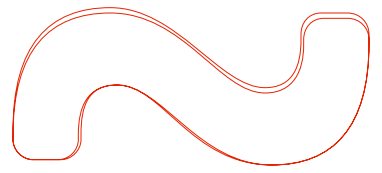
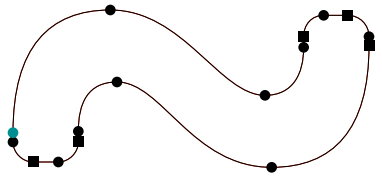

PROGRAM

.....
Program Book | ogonek | RoboFog Sketches | 2013 | Emigre Fonts

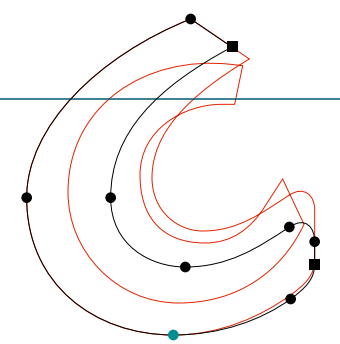

PROGRAM

.....
Program BookItalic | ordfeminine | RoboFog Sketches | 2013 | Emigre Fonts

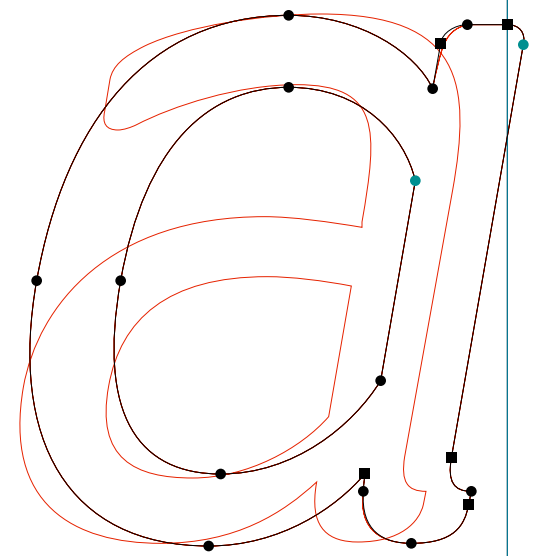

PROGRAM

.....
Program Medium | dollar | RoboFog Sketches | 2013 | Emigre Fonts

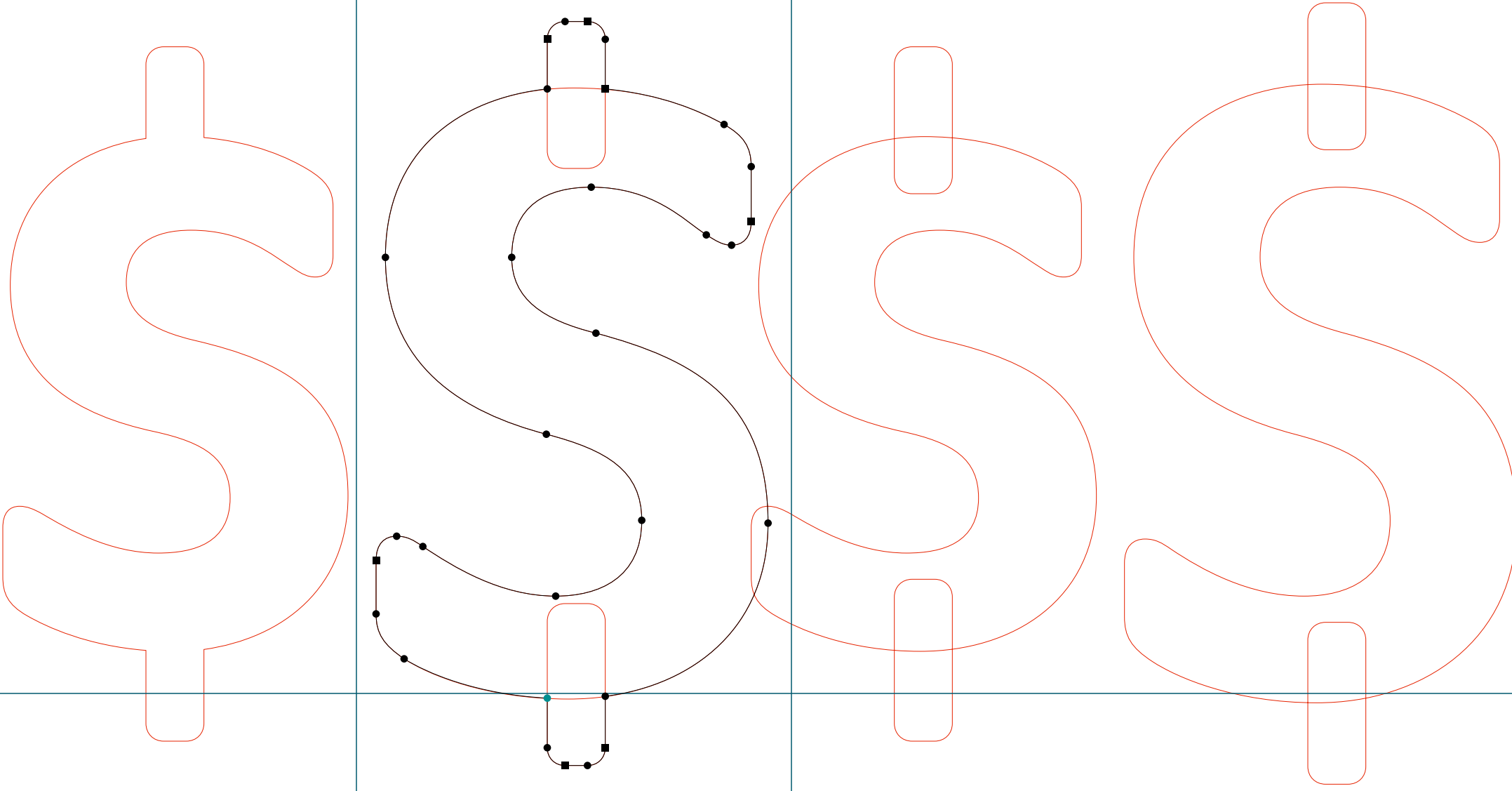

PROGRAM

Program Medium | ampersand | RoboFog Sketches | 2013 | Emigre Fonts

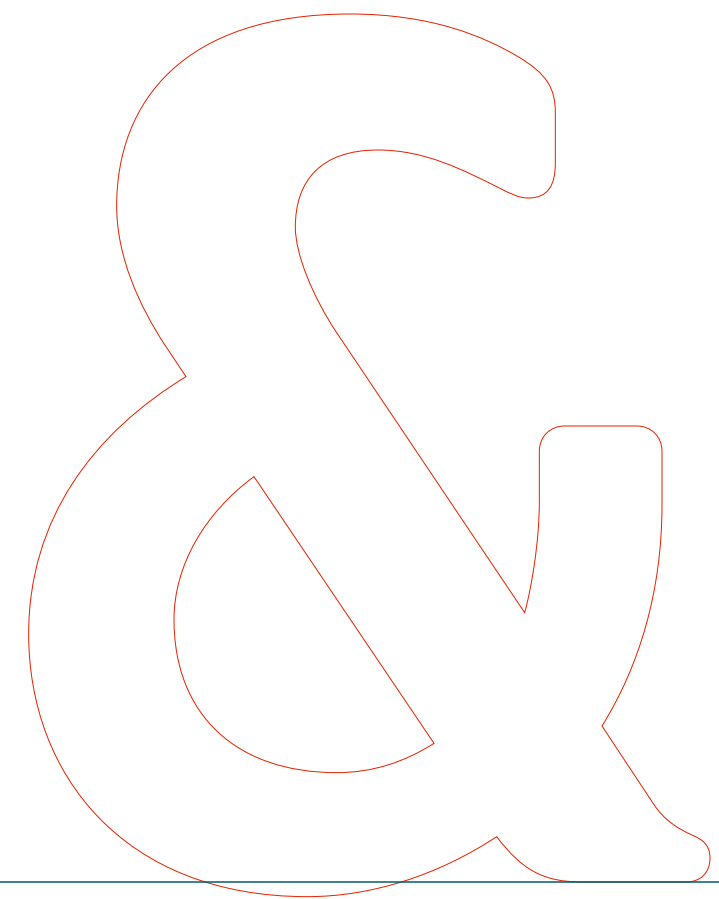
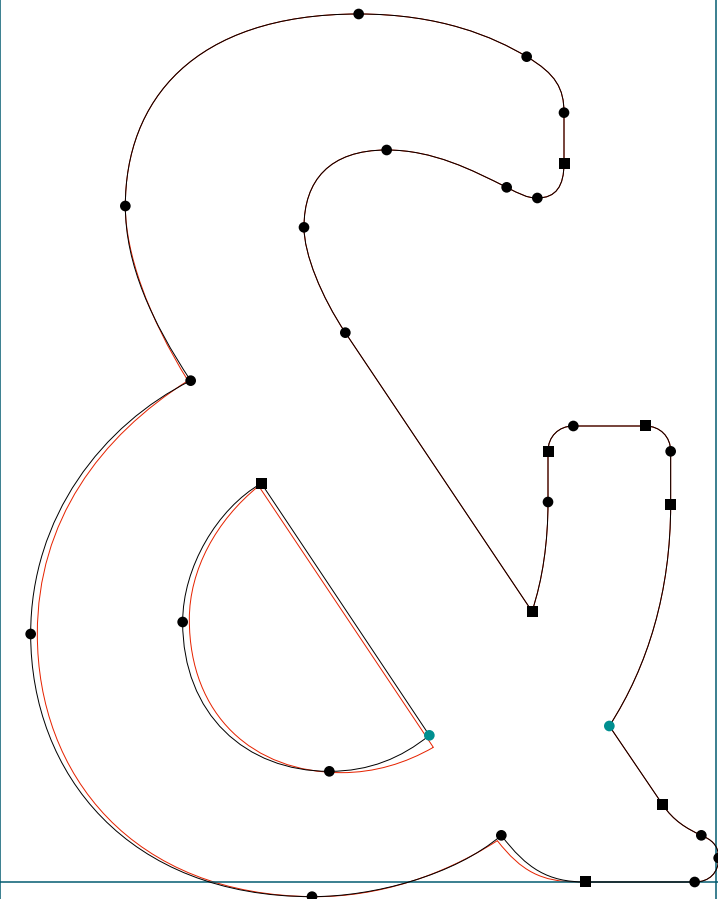
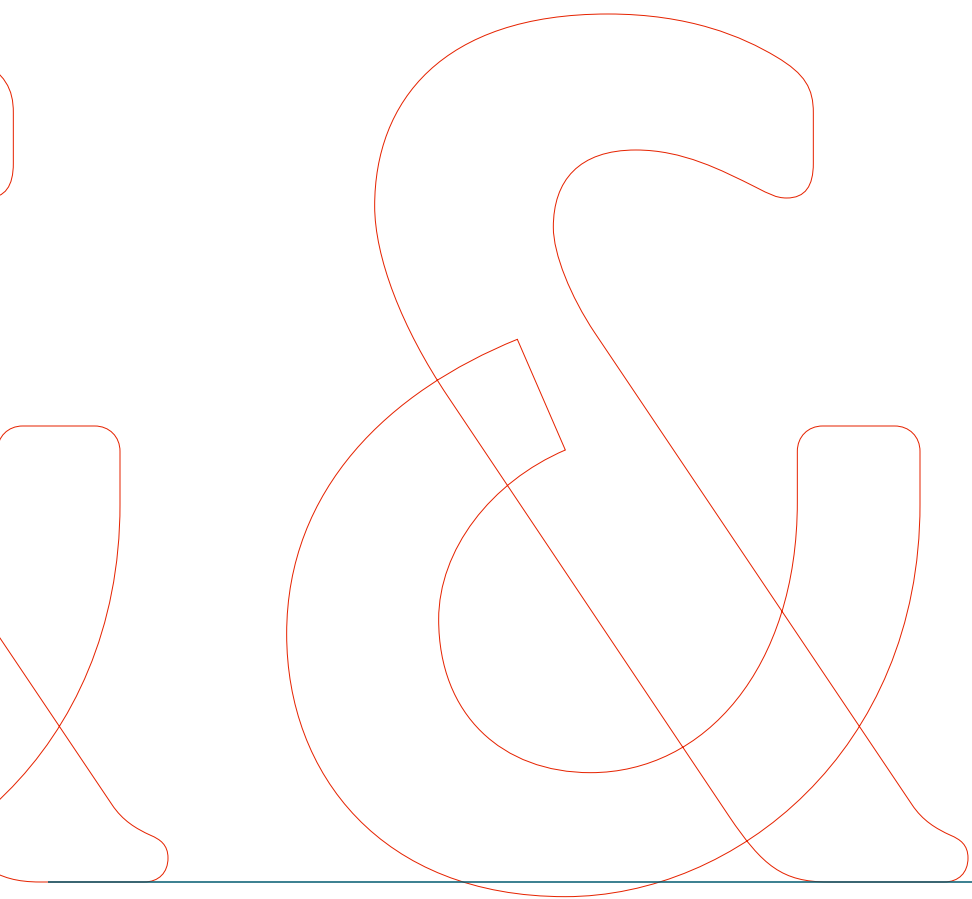

PROGRAM

.....
Program Medium | W | RoboFog Sketches | 2013 | Emigre Fonts

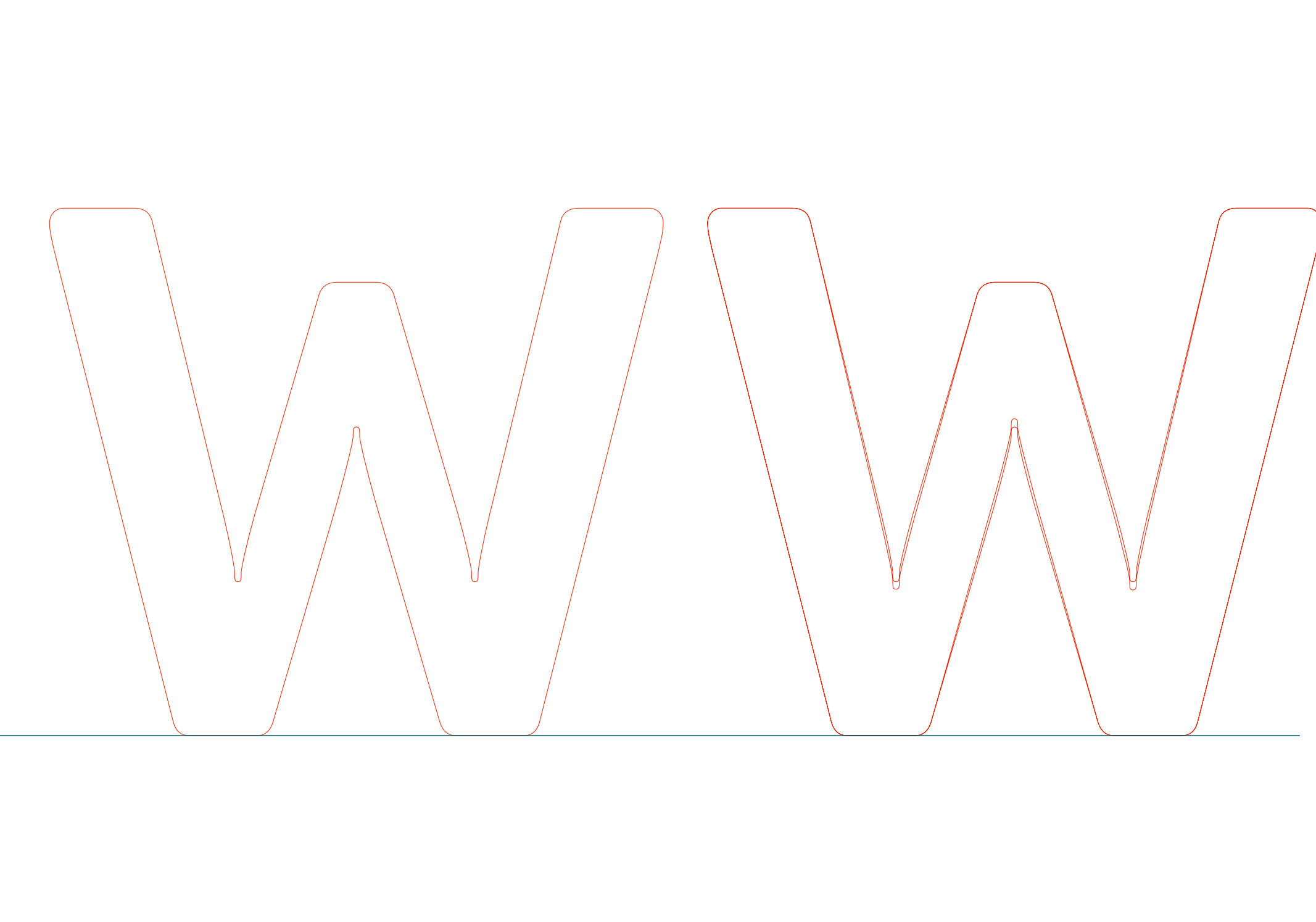
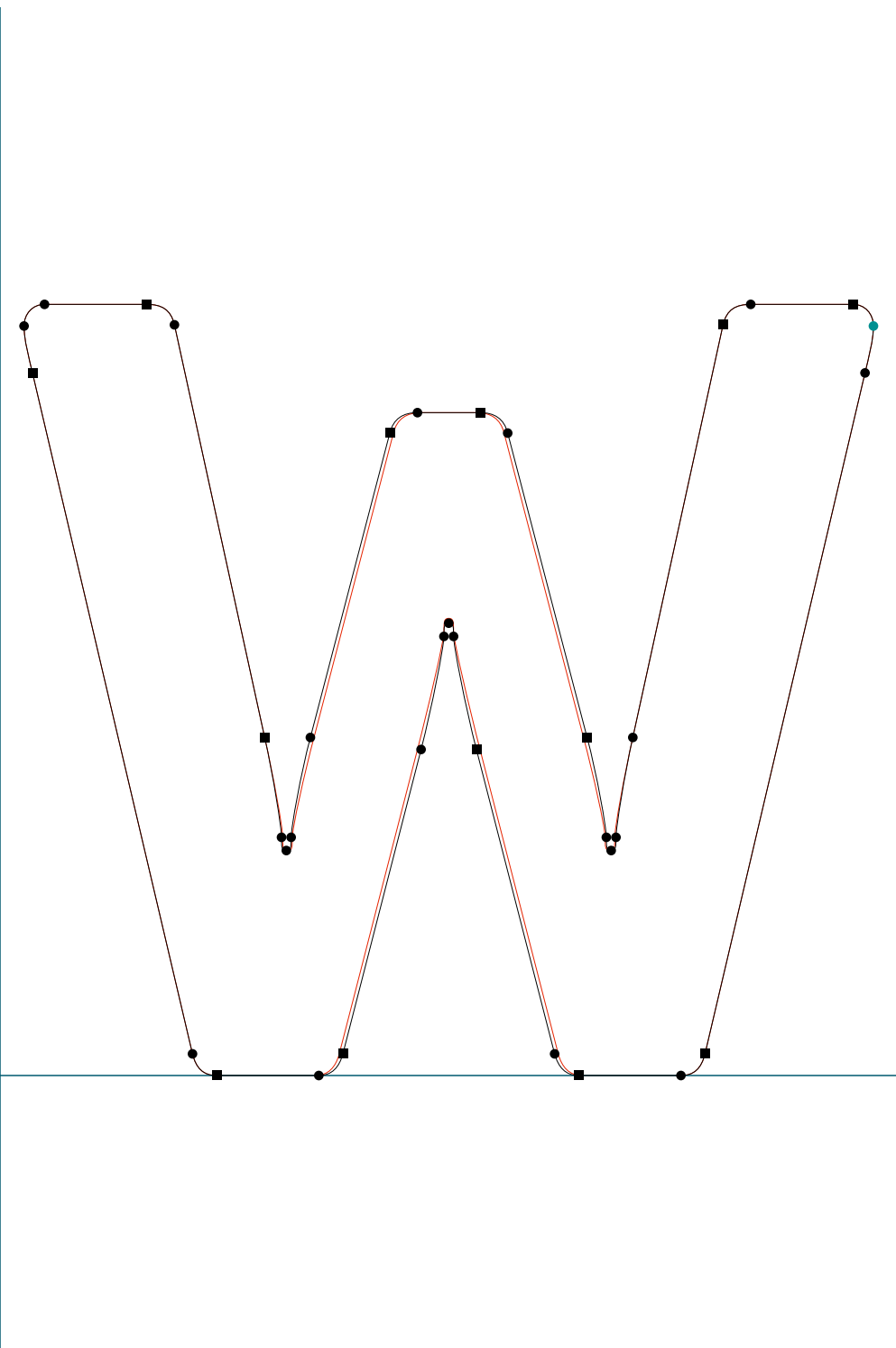

PROGRAM

.....
Program Medium | cent | RoboFog Sketches | 2013 | Emigre Fonts

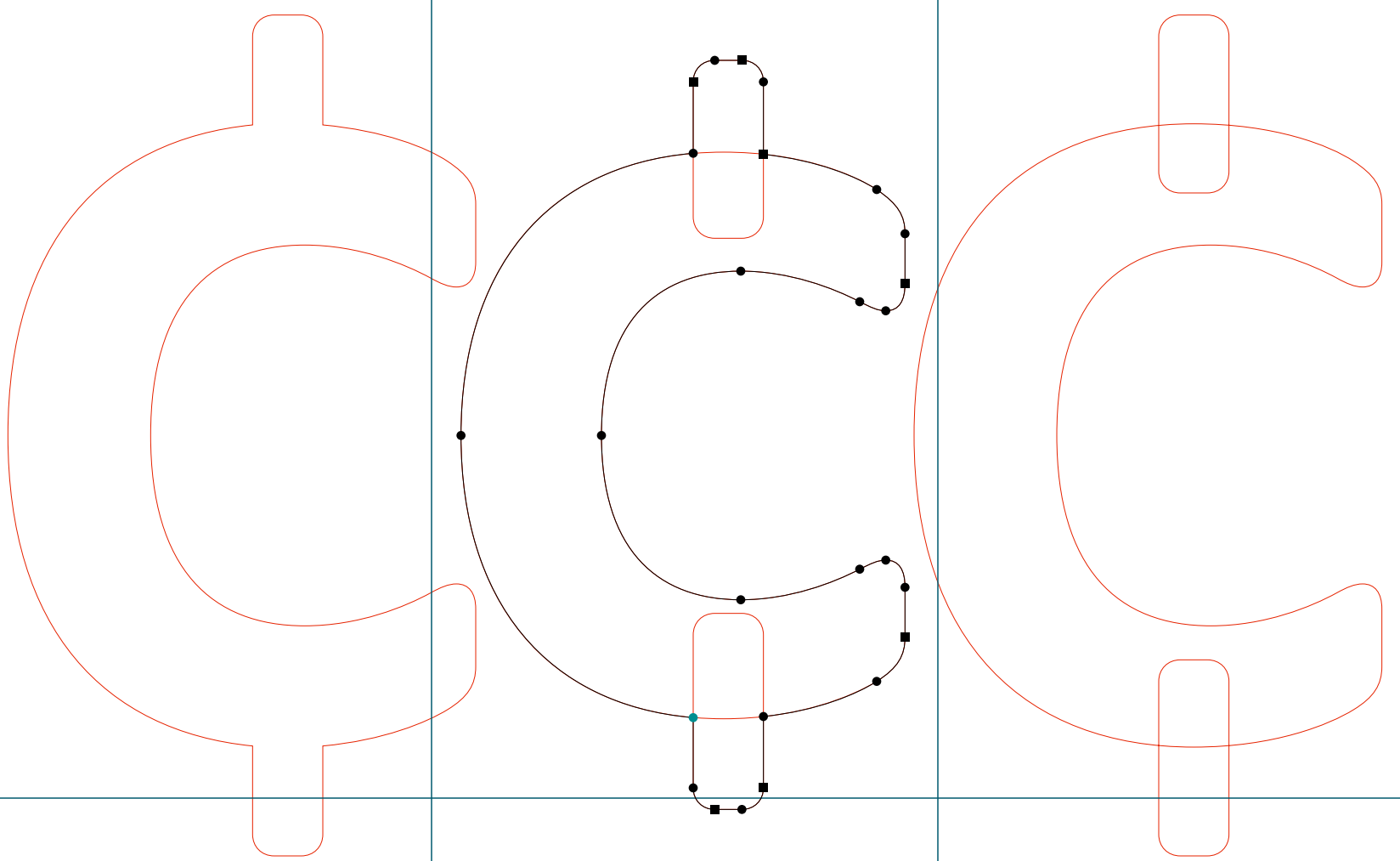

PROGRAM

.....
Program MediumItalic | ampersand | RoboFog Sketches | 2013 | Emigre Fonts

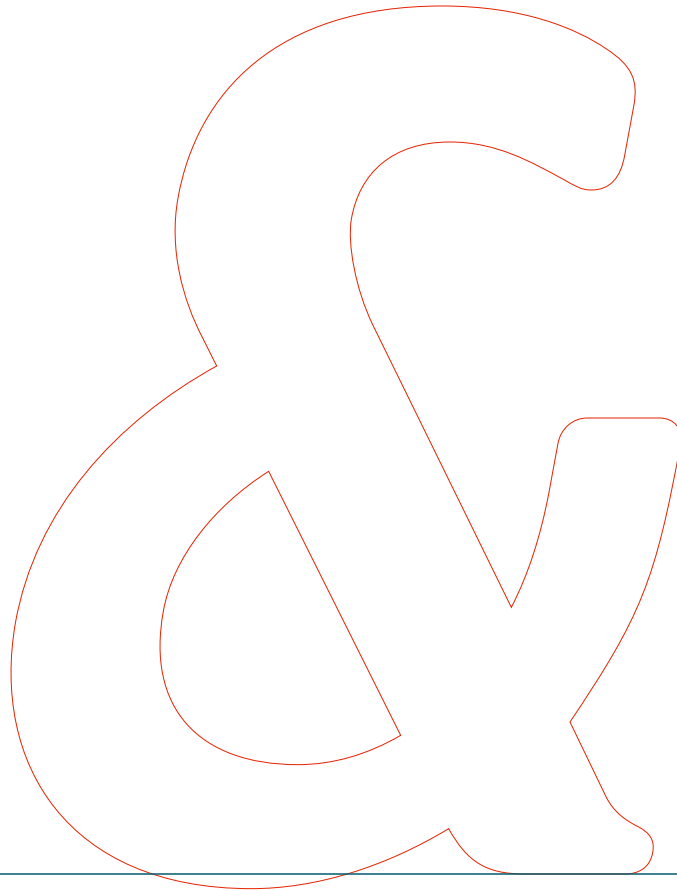
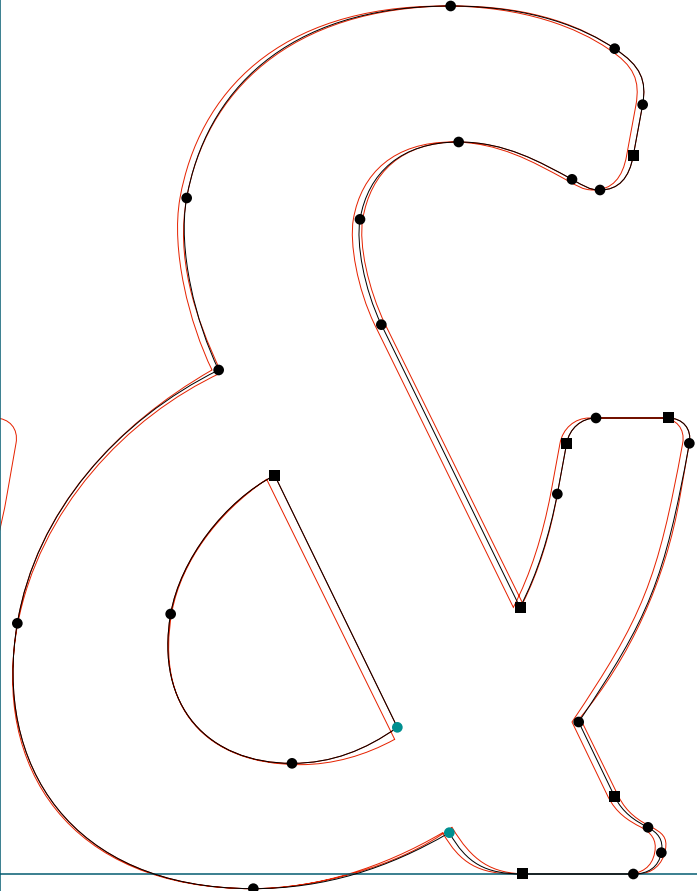
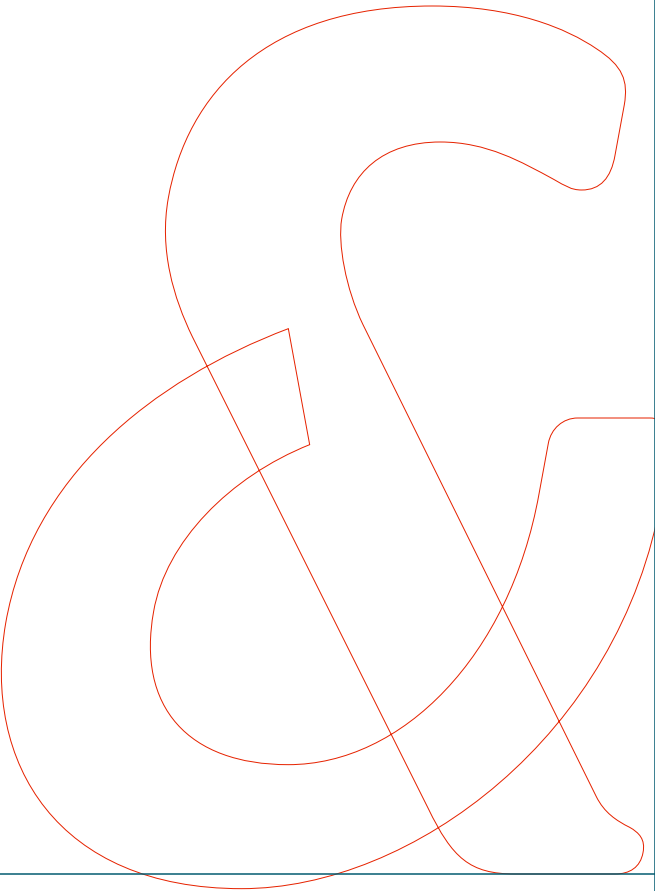

PROGRAM

.....
Program MediumItalic | S | RoboFog Sketches | 2013 | Emigre Fonts

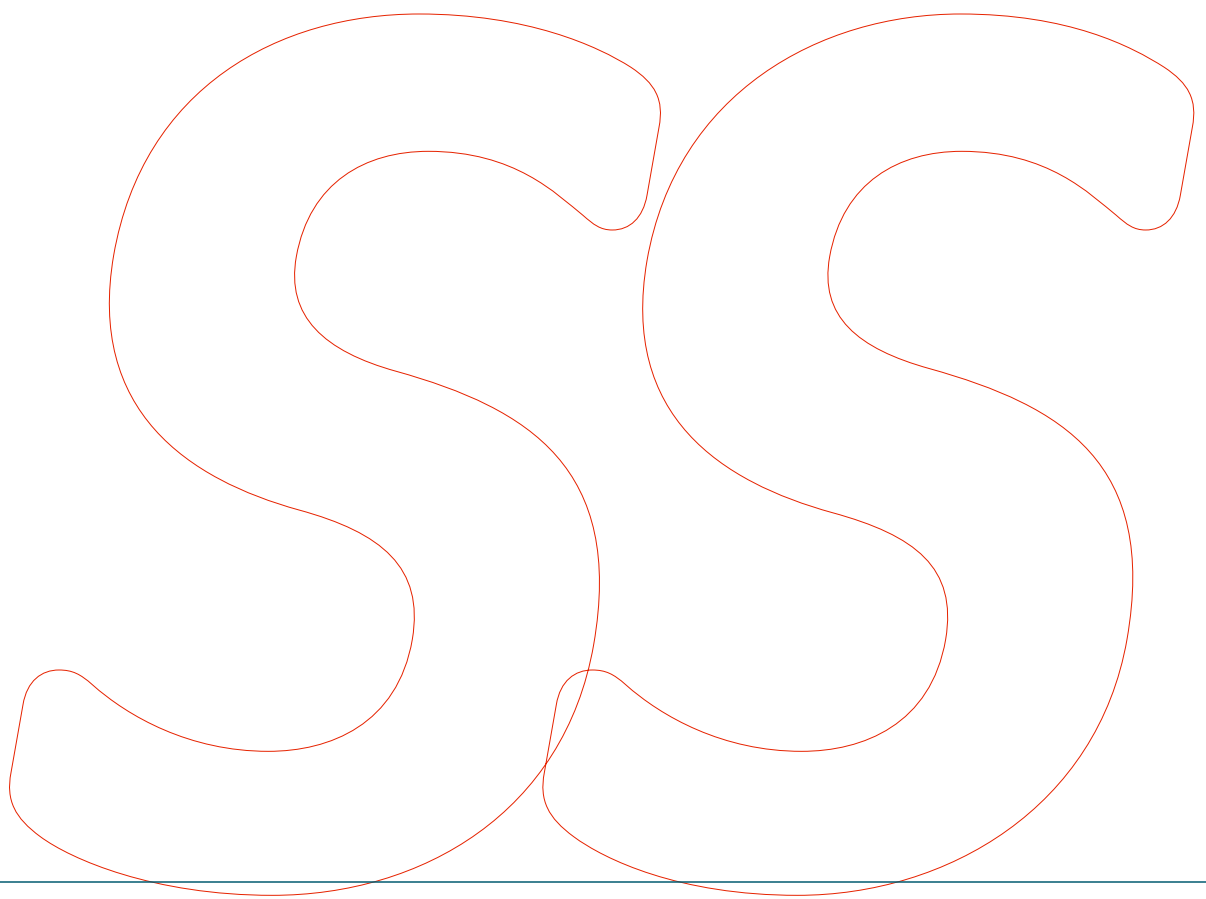
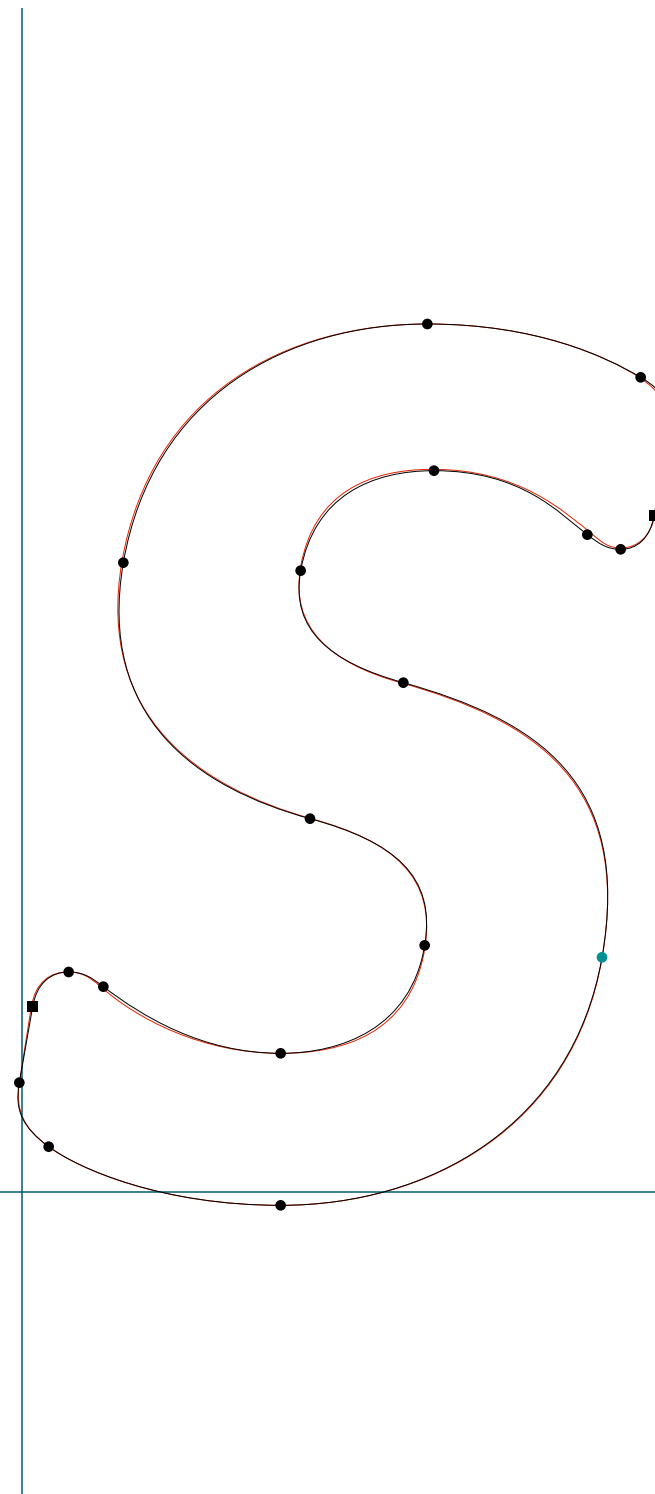

PROGRAM

.....
Program MediumItalic | a | RoboFog Sketches | 2013 | Emigre Fonts

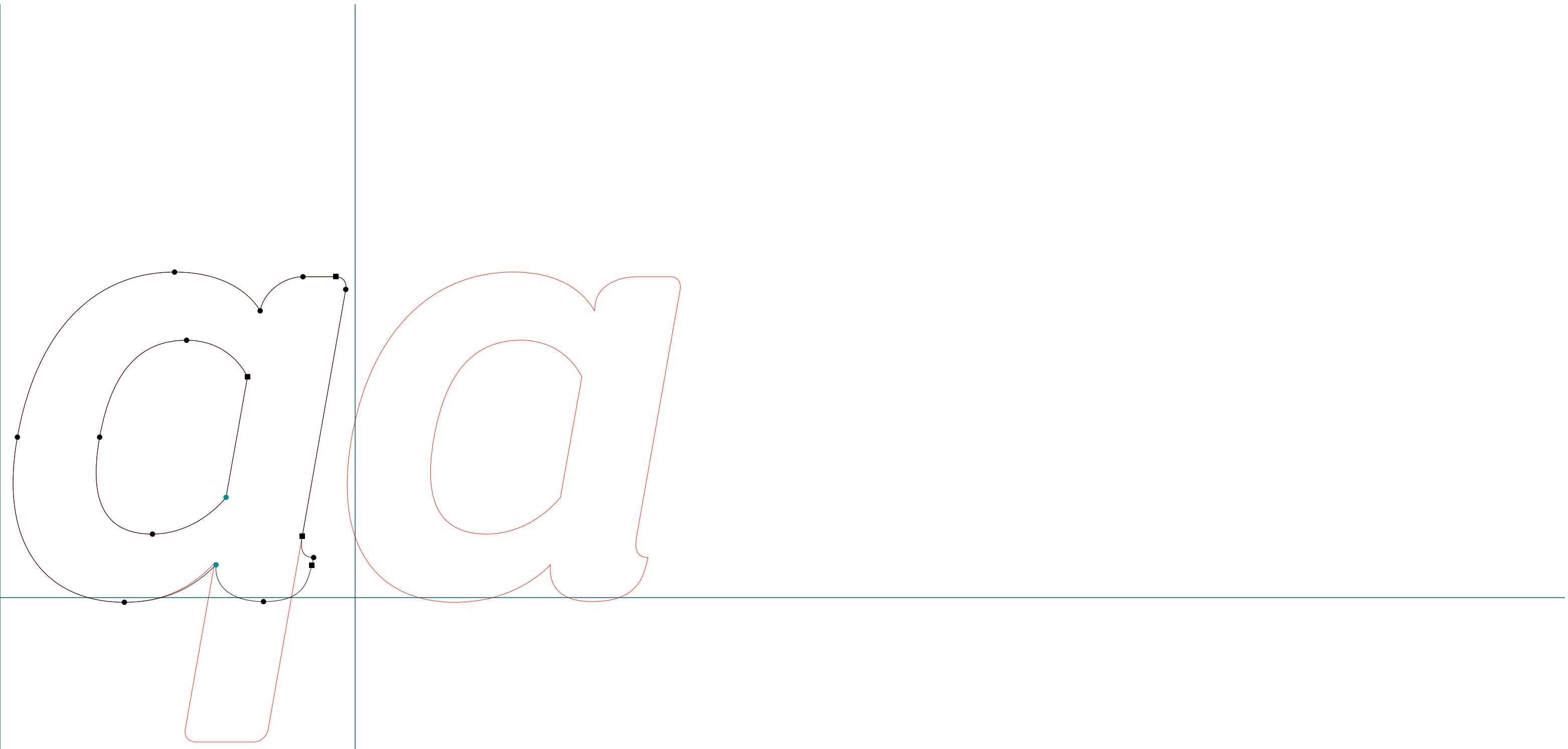

PROGRAM

.....
Program Bold | exclam | RoboFog Sketches | 2013 | Emigre Fonts

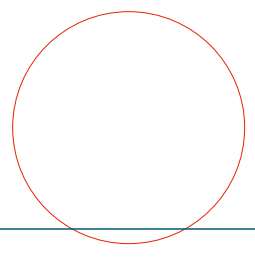
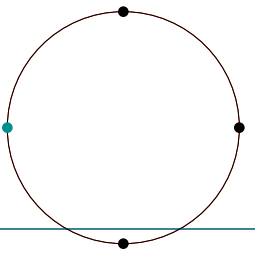
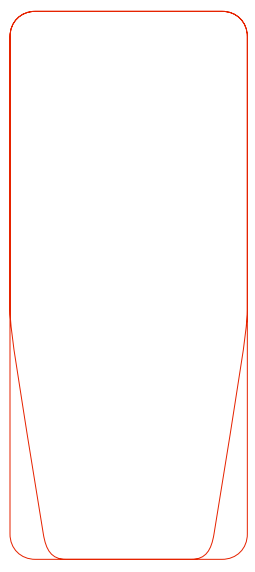
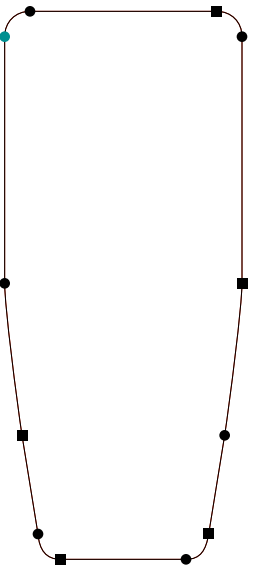

PROGRAM

.....
Program Bold | dollar | RoboFog Sketches | 2013 | Emigre Fonts

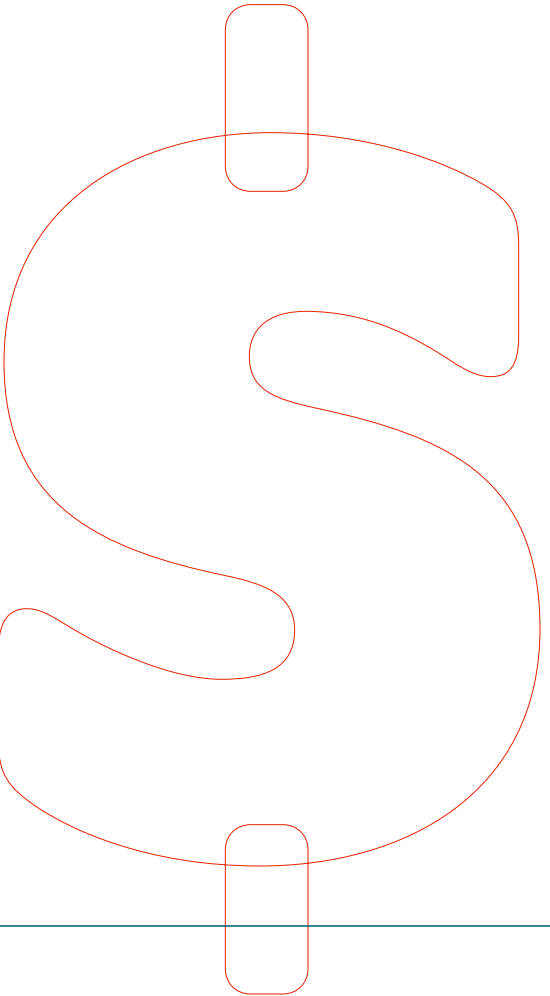
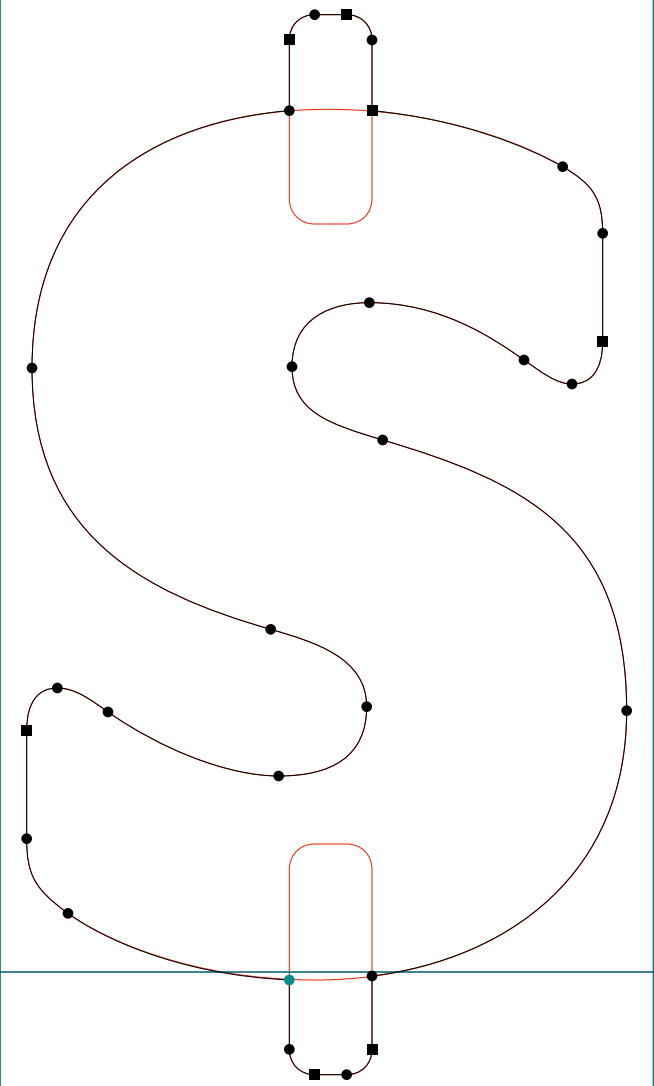
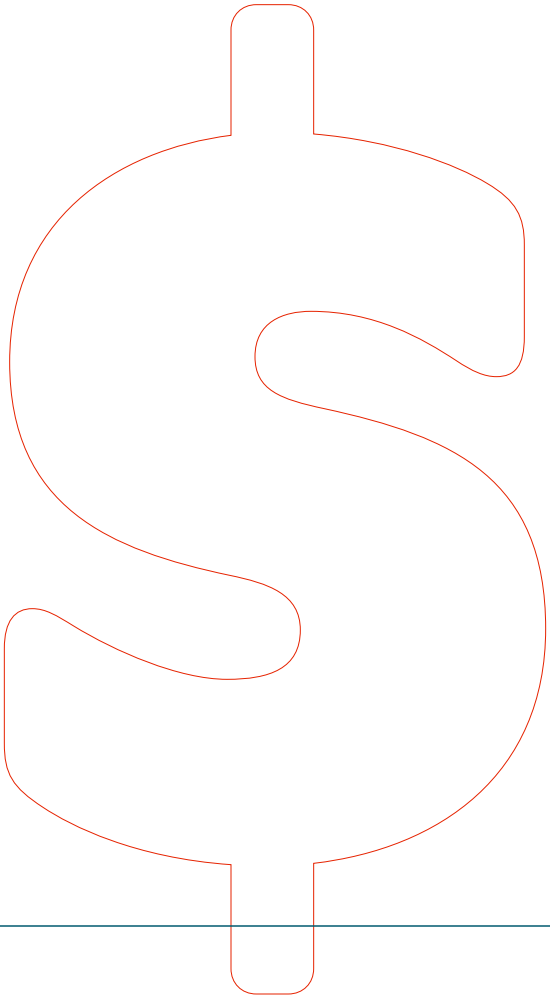

PROGRAM

Program Bold | ampersand | RoboFog Sketches | 2013 | Emigre Fonts

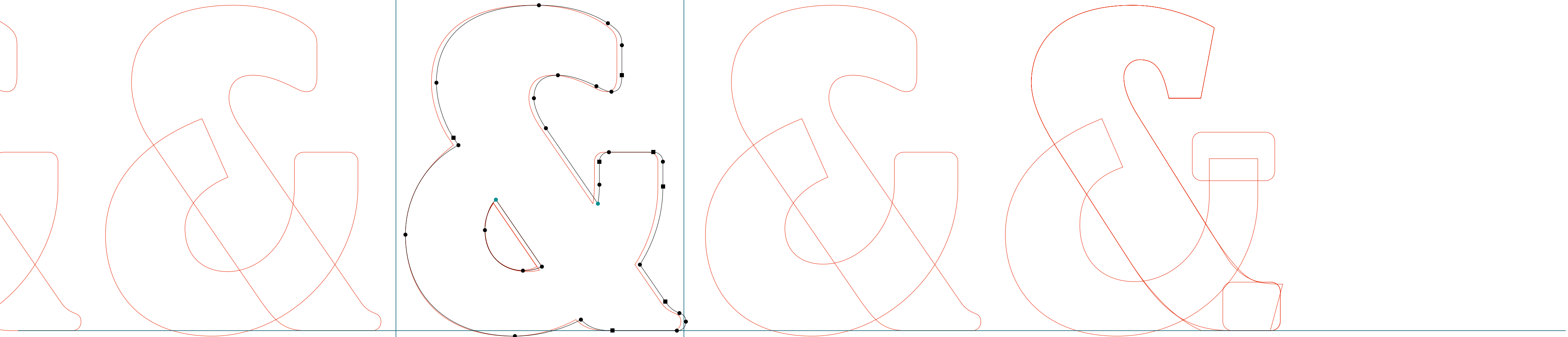

PROGRAM

.....
Program Bold | asterisk | RoboFog Sketches | 2013 | Emigre Fonts

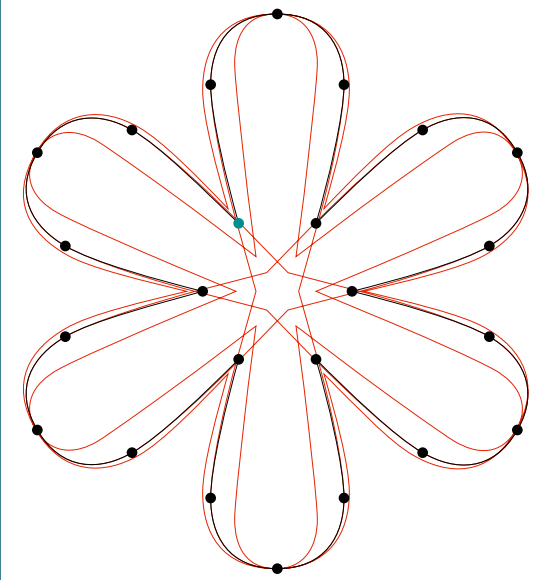

PROGRAM

.....
Program Bold | comma | RoboFog Sketches | 2013 | Emigre Fonts

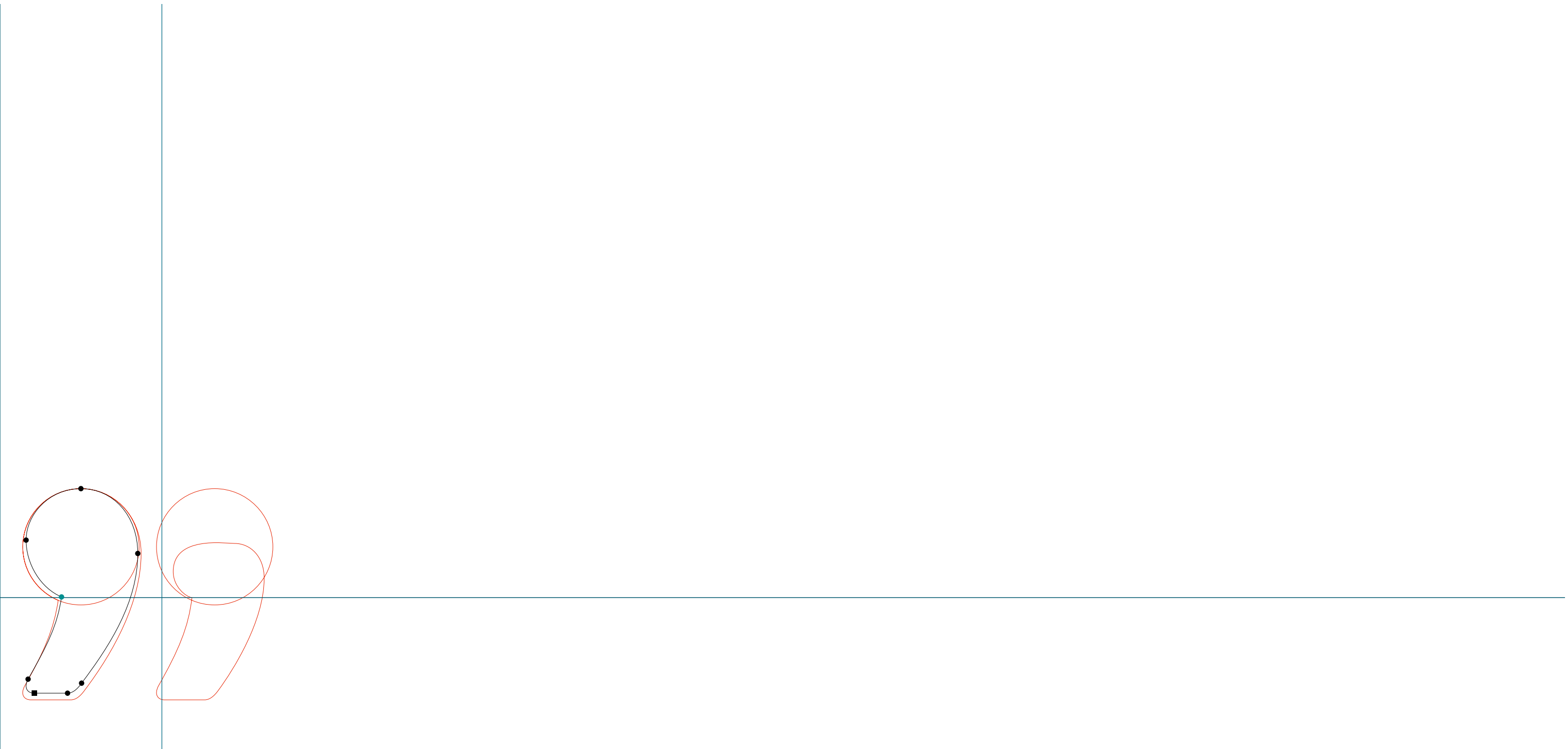

PROGRAM

.....
Program Bold | two | RoboFog Sketches | 2013 | Emigre Fonts

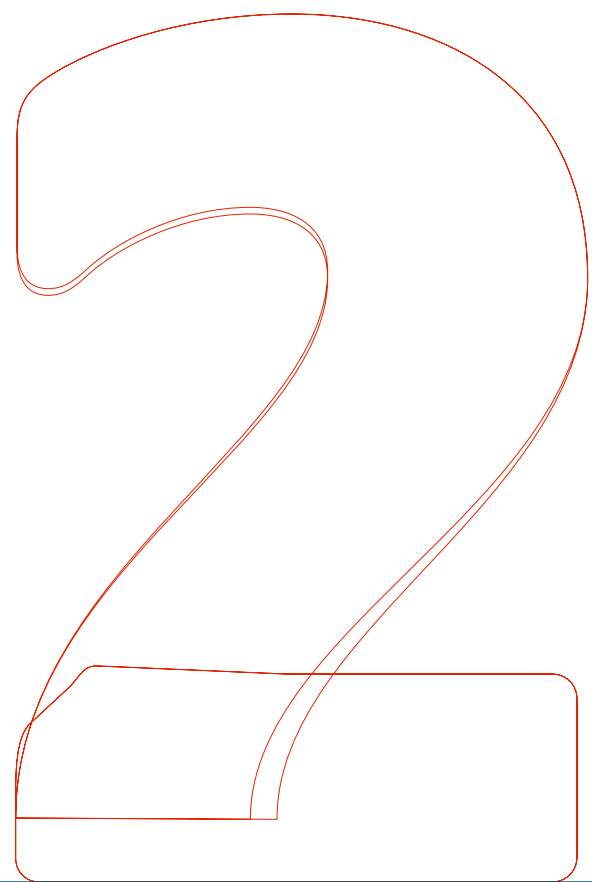
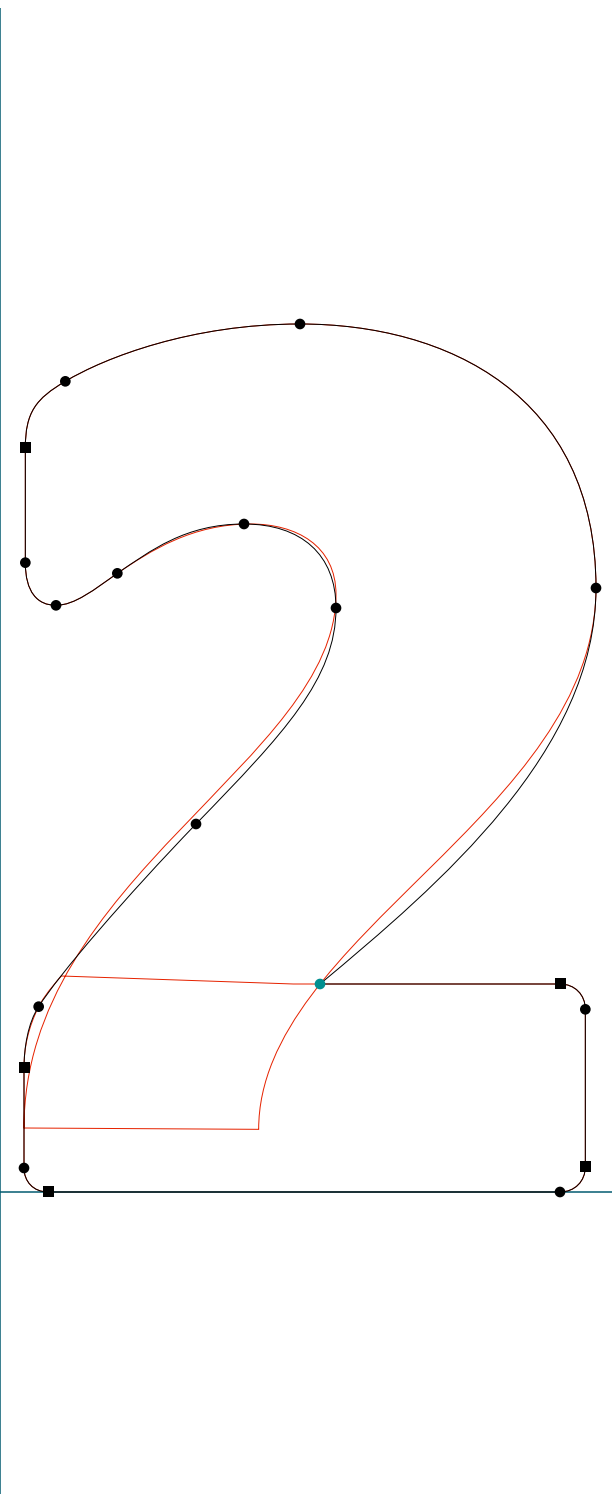

PROGRAM

.....
Program Bold | three | RoboFog Sketches | 2013 | Emigre Fonts

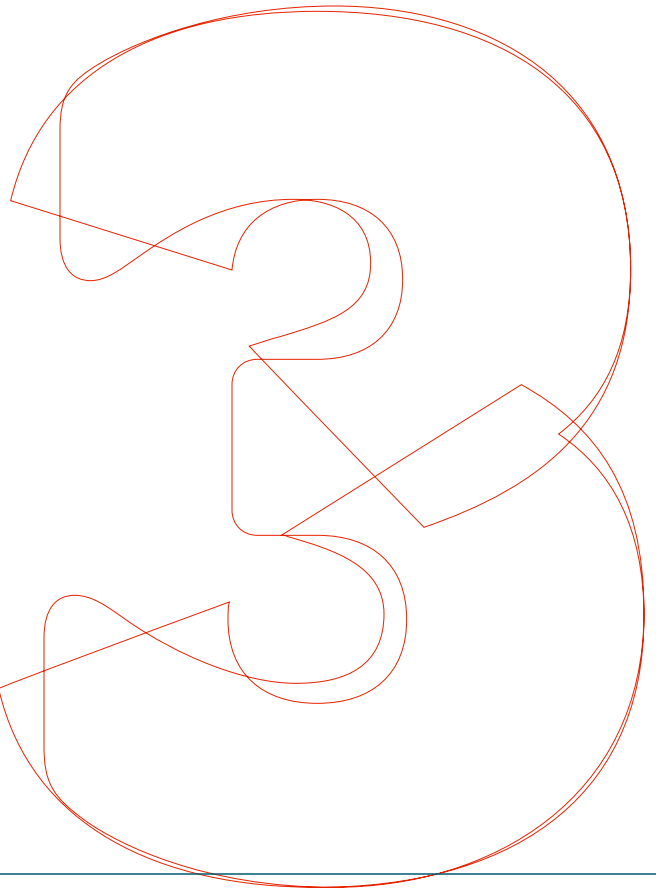
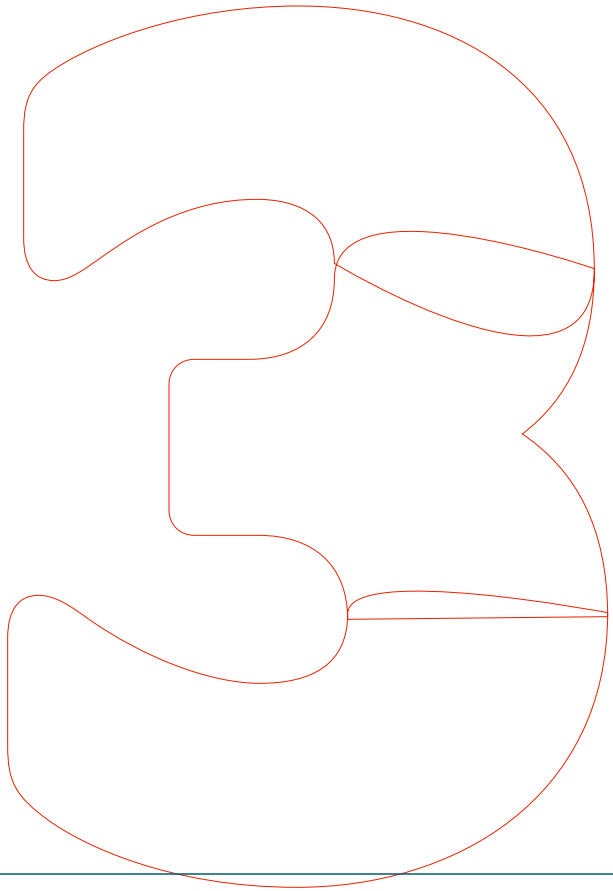
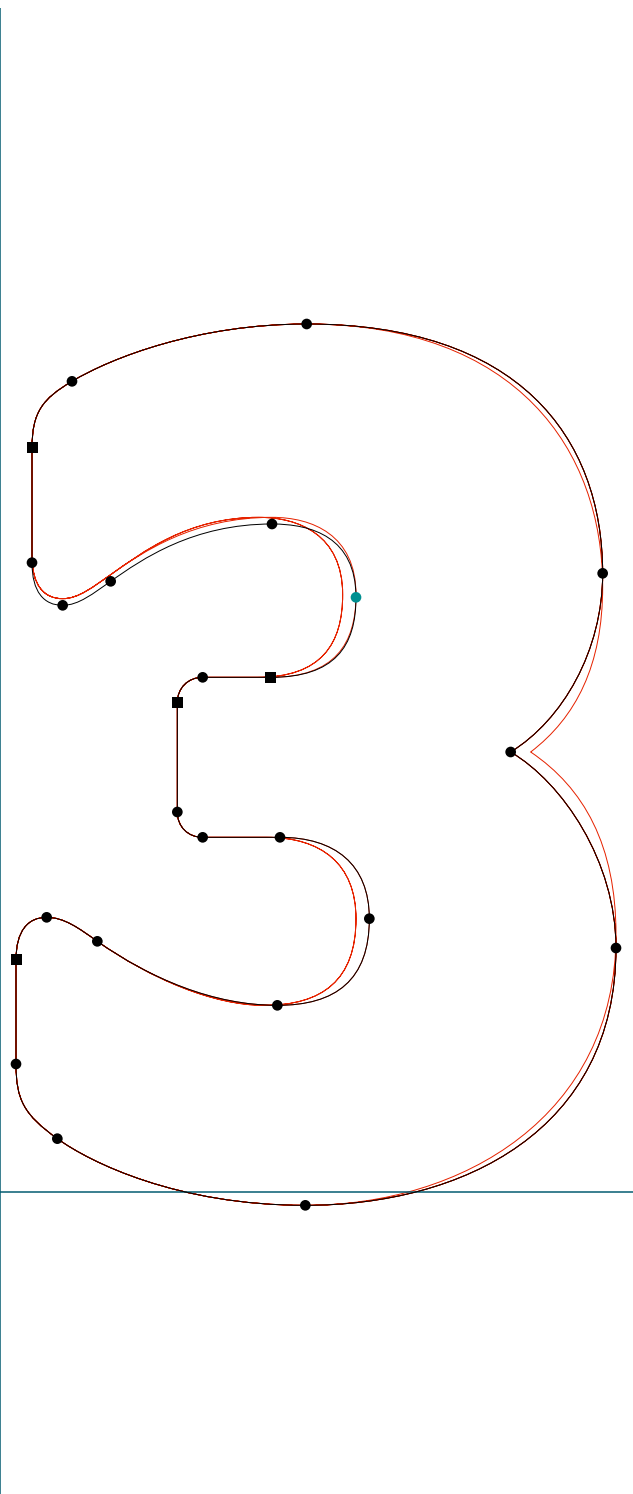

PROGRAM

.....
Program Bold | four | RoboFog Sketches | 2013 | Emigre Fonts

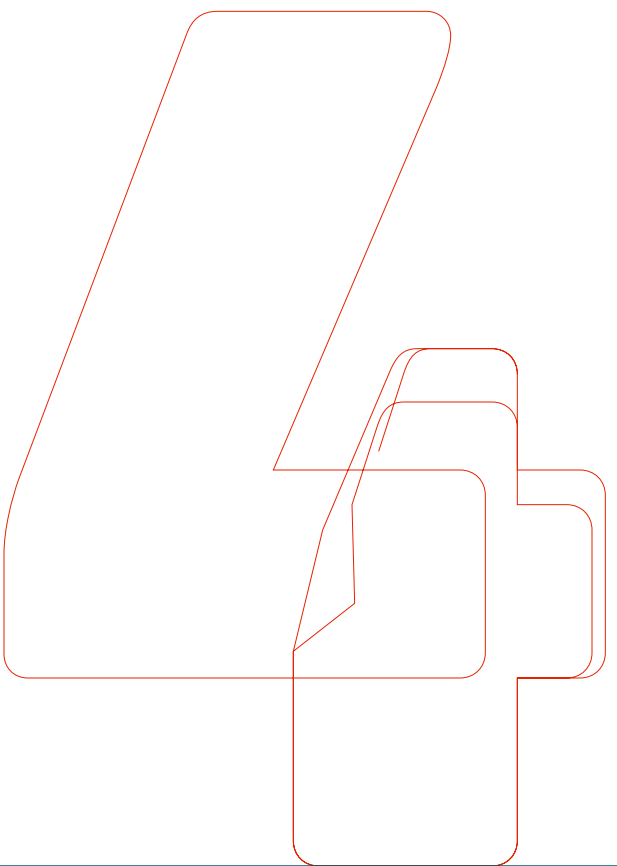
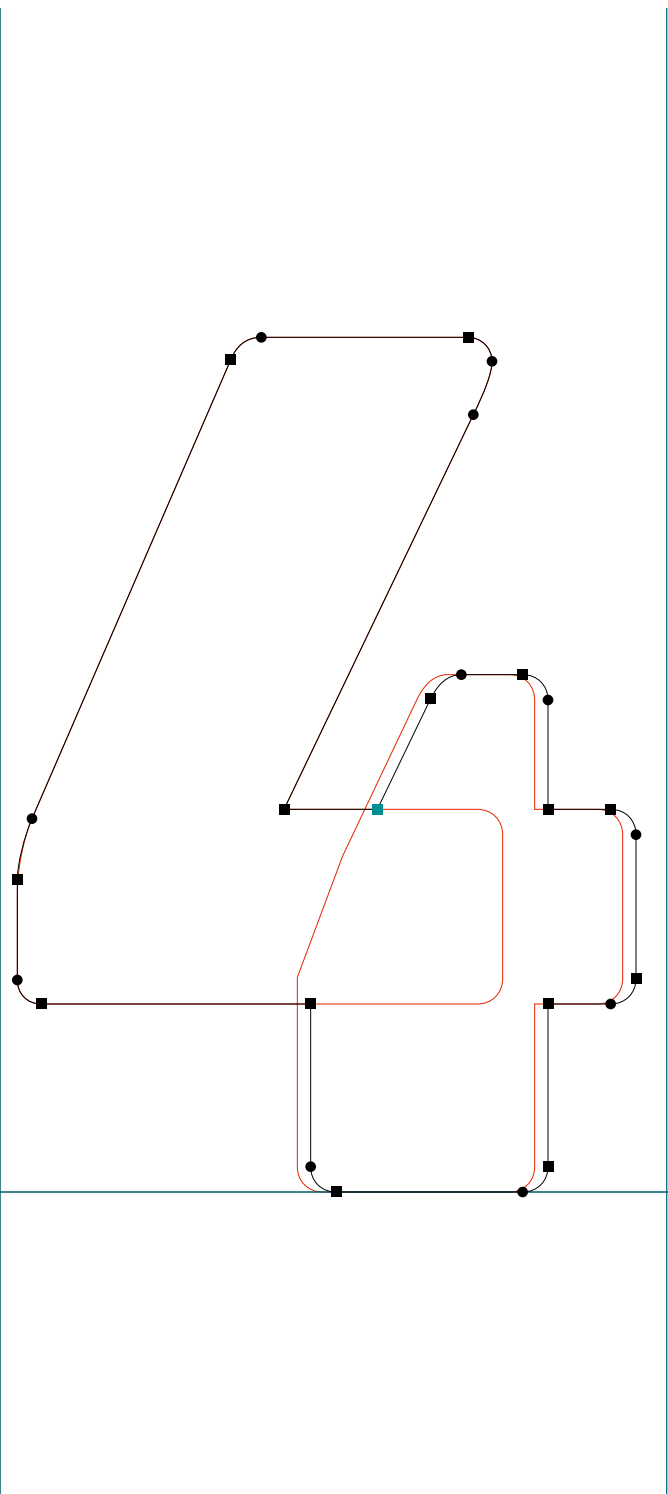

PROGRAM

.....
Program Bold | six | RoboFog Sketches | 2013 | Emigre Fonts

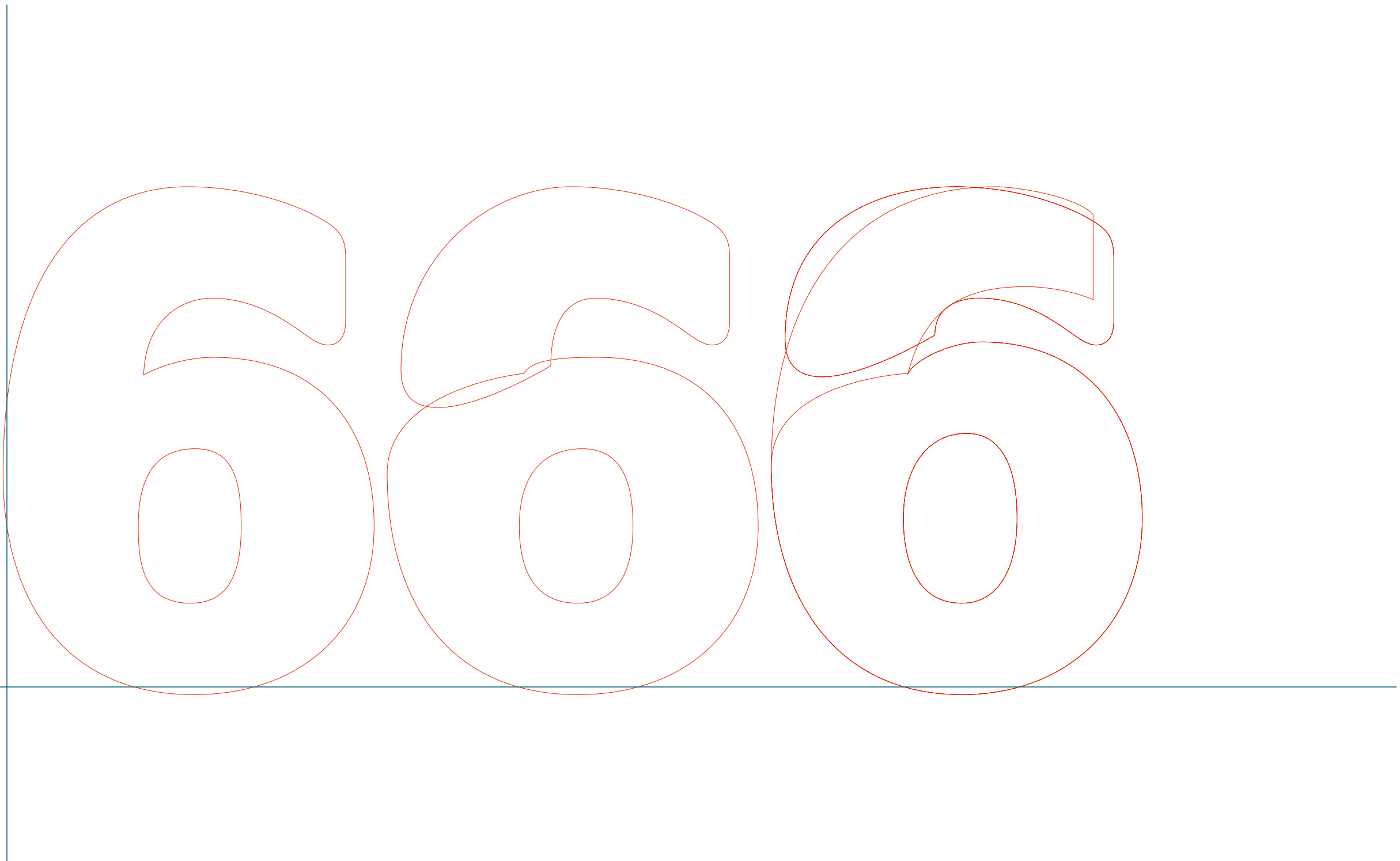
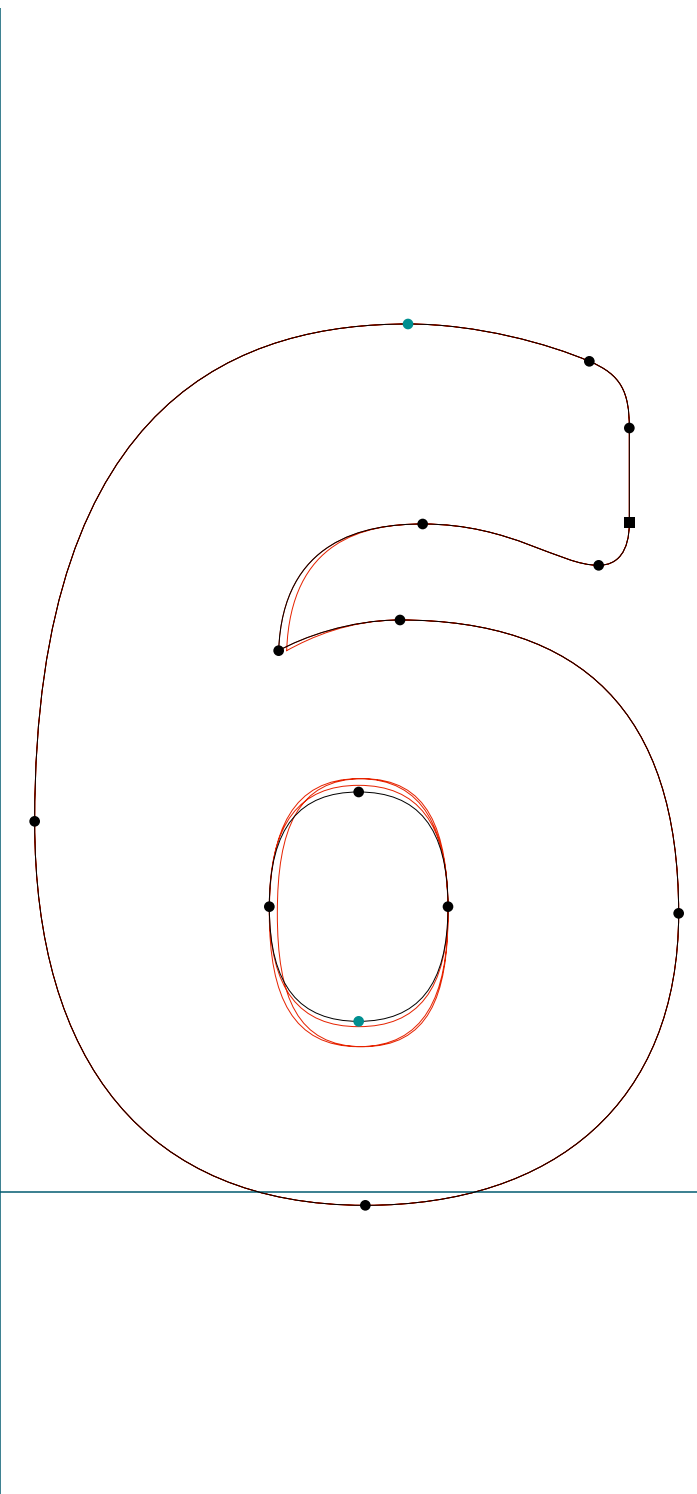

PROGRAM

.....
Program Bold | eight | RoboFog Sketches | 2013 | Emigre Fonts

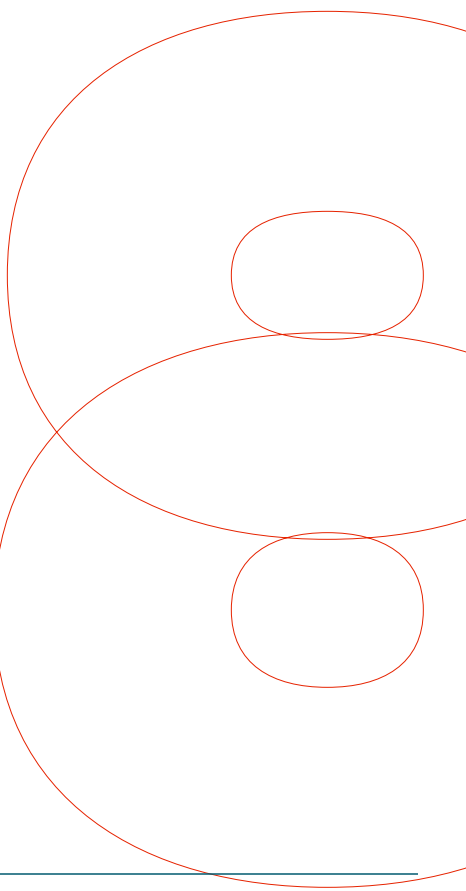
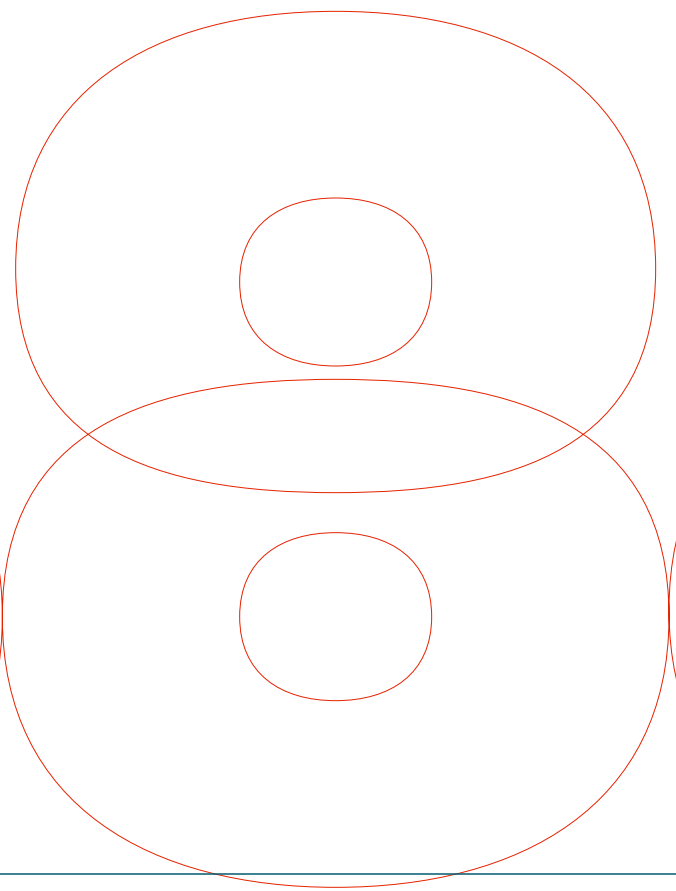
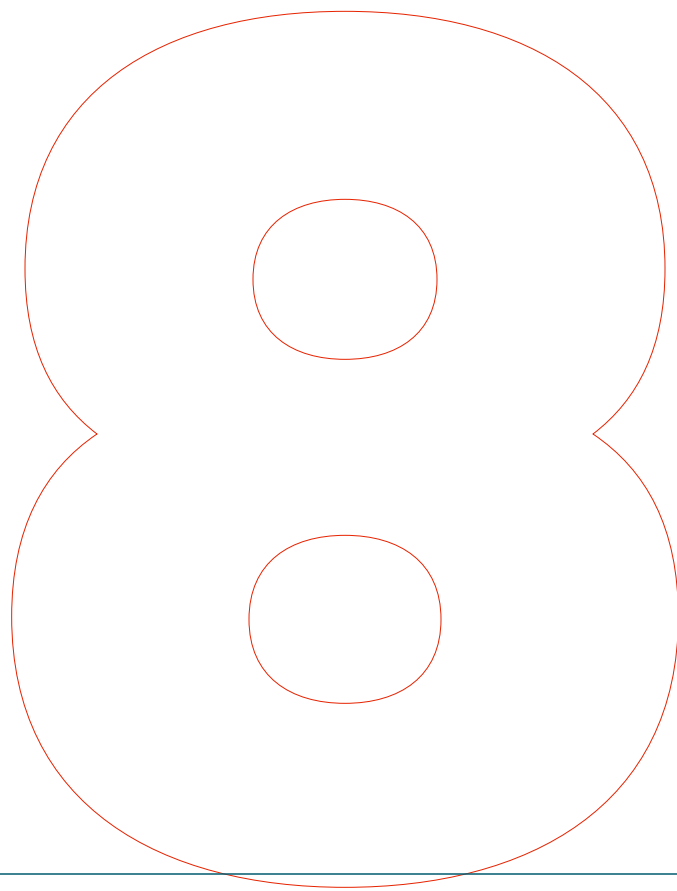
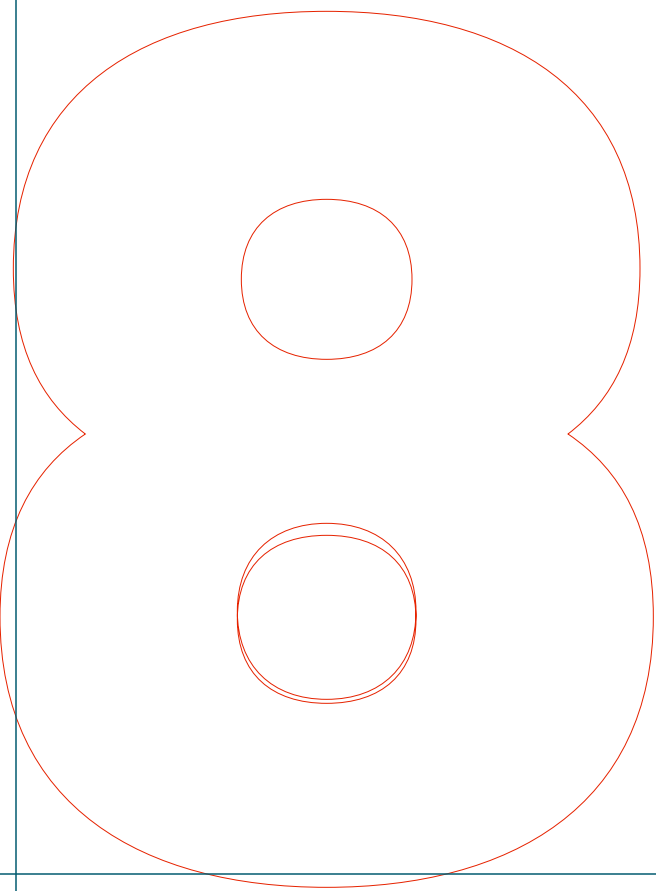
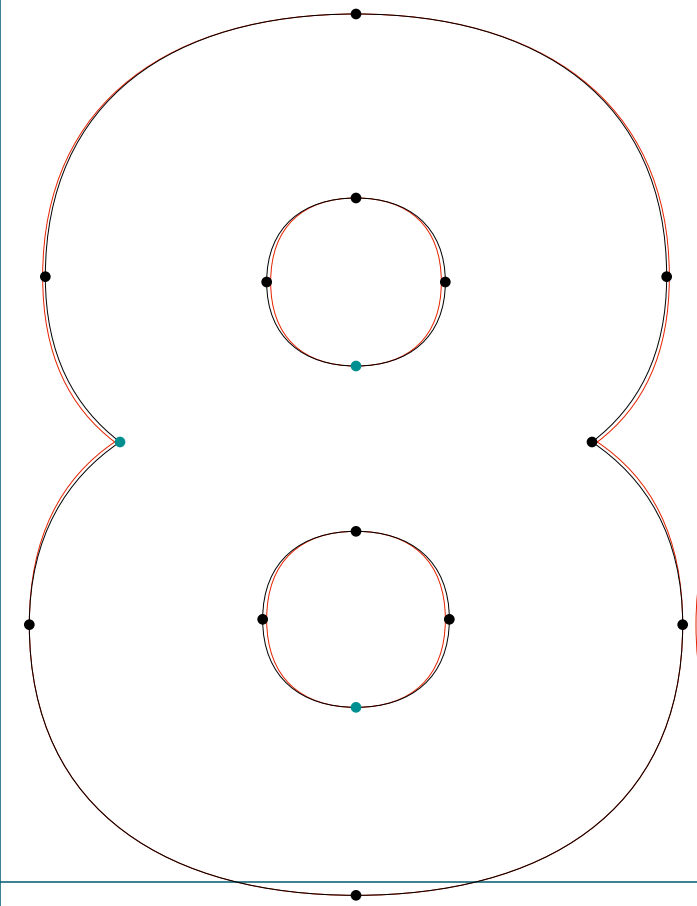

PROGRAM

.....
Program Bold | question | RoboFog Sketches | 2013 | Emigre Fonts

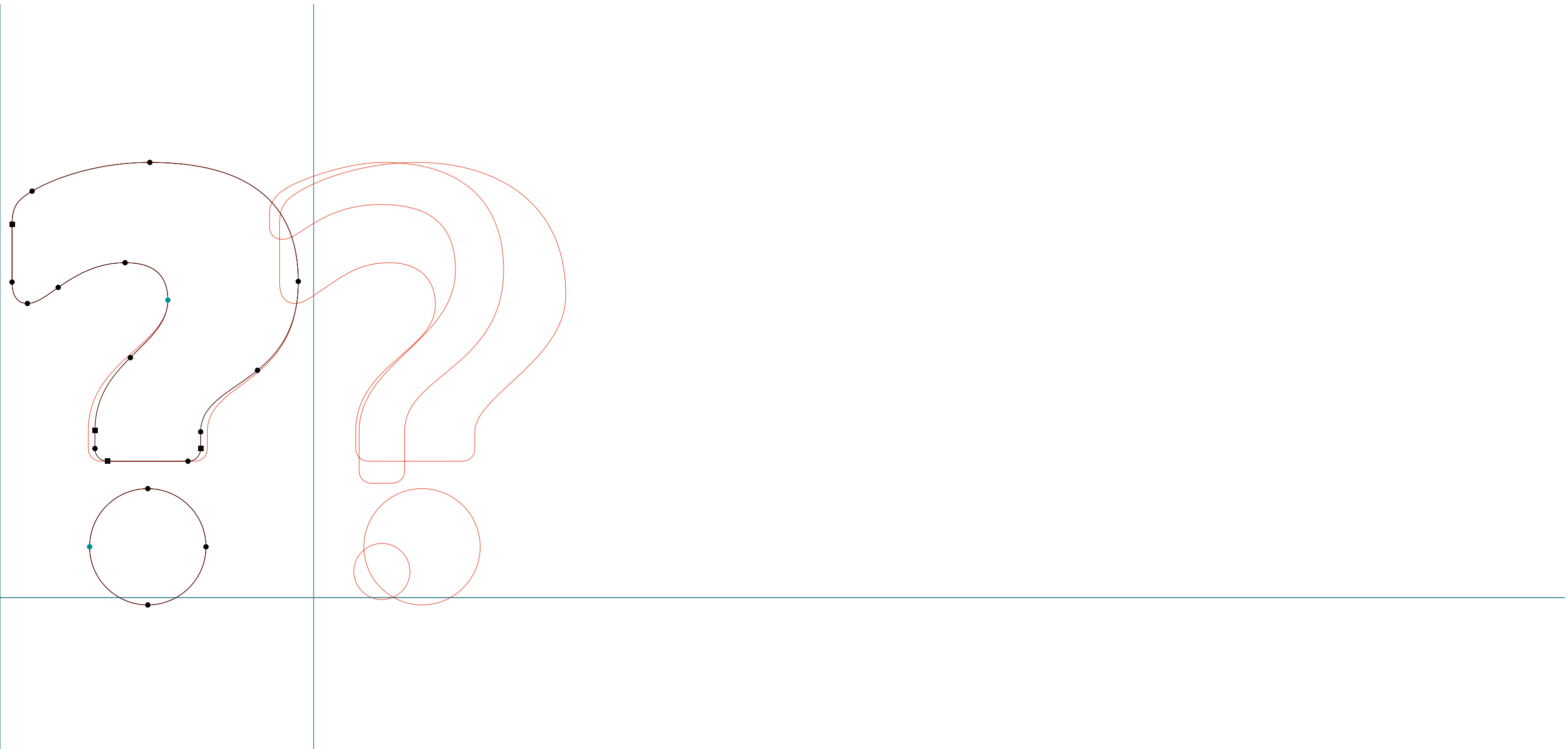

PROGRAM

.....
Program Bold | A | RoboFog Sketches | 2013 | Emigre Fonts

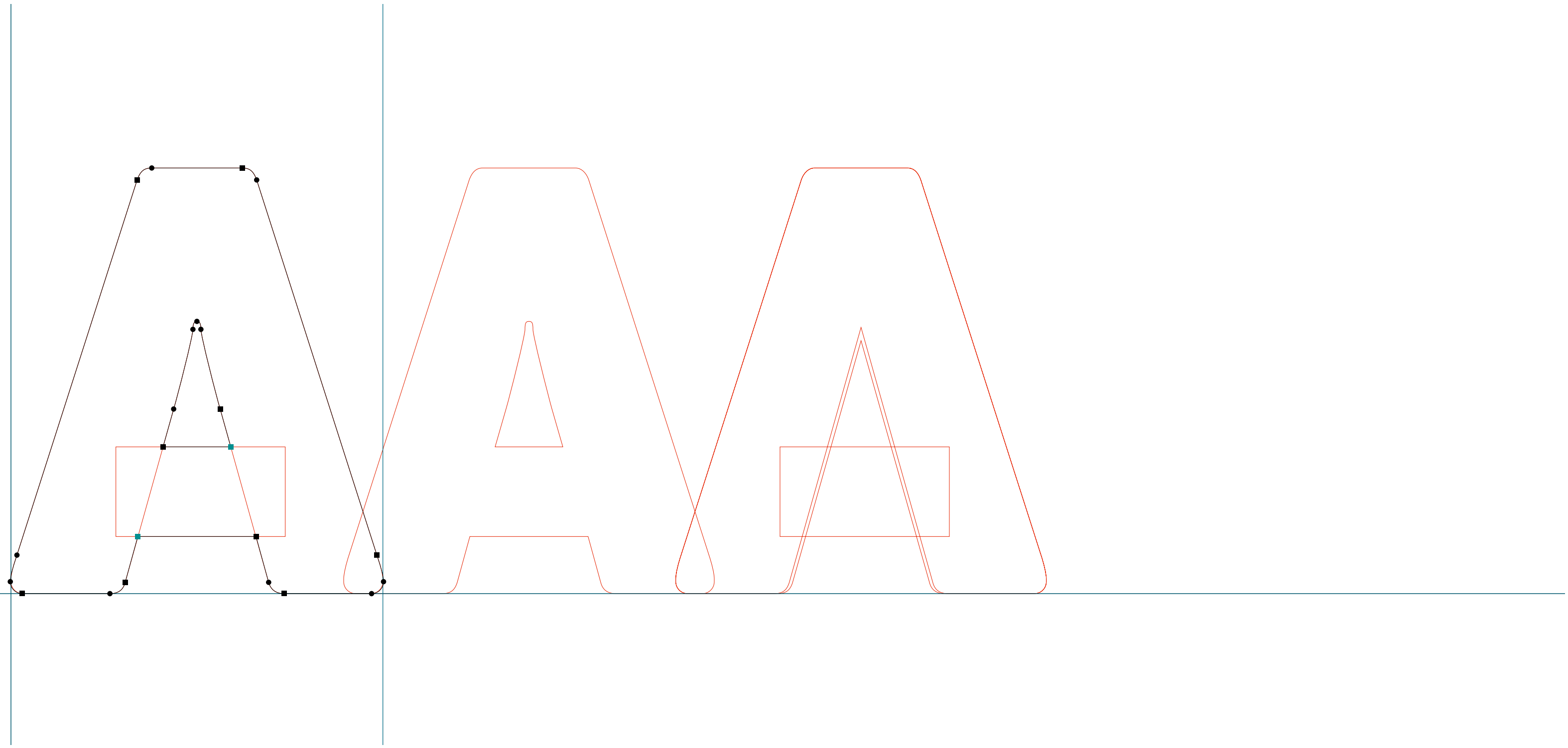

PROGRAM

.....
Program Bold | E | RoboFog Sketches | 2013 | Emigre Fonts

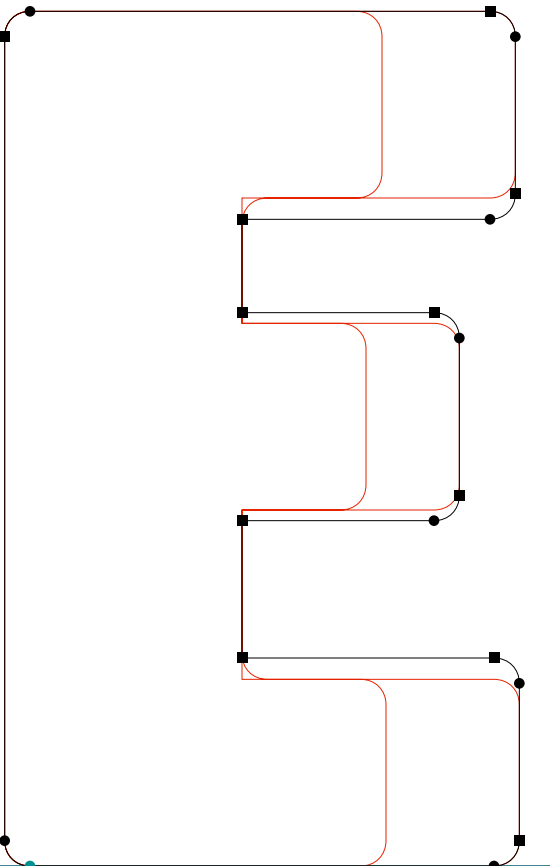

PROGRAM

.....
Program Bold | G | RoboFog Sketches | 2013 | Emigre Fonts

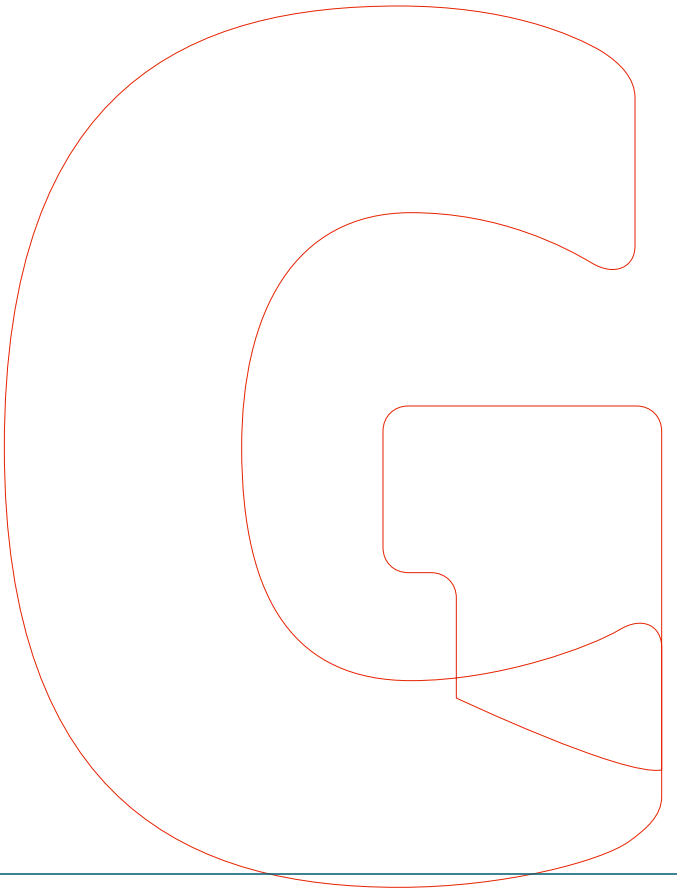
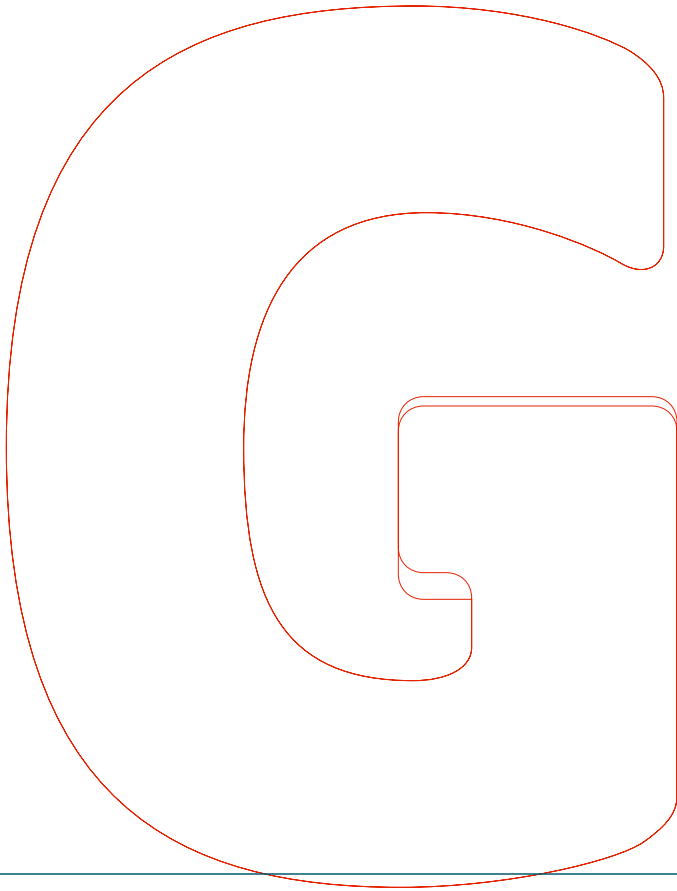
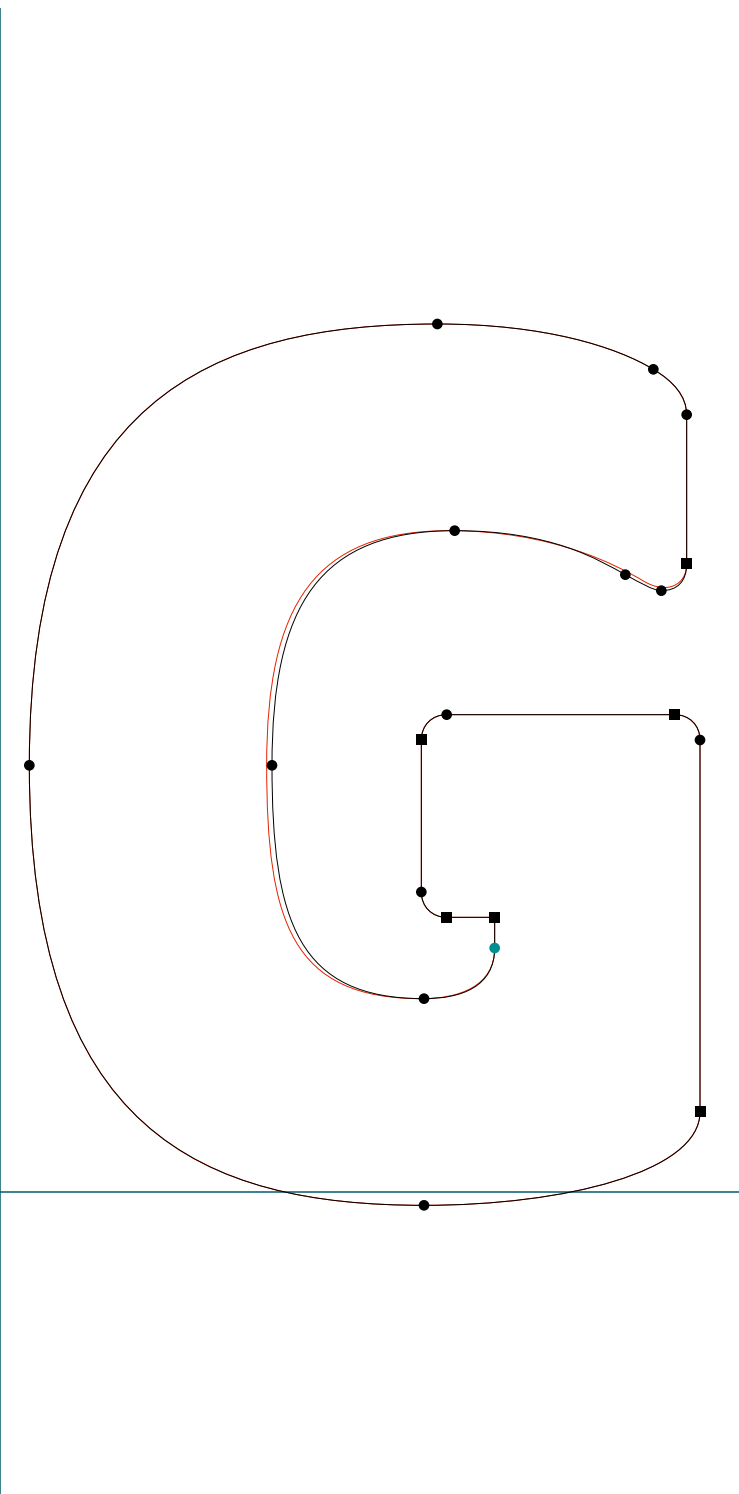

PROGRAM

.....
Program Bold | J | RoboFog Sketches | 2013 | Emigre Fonts

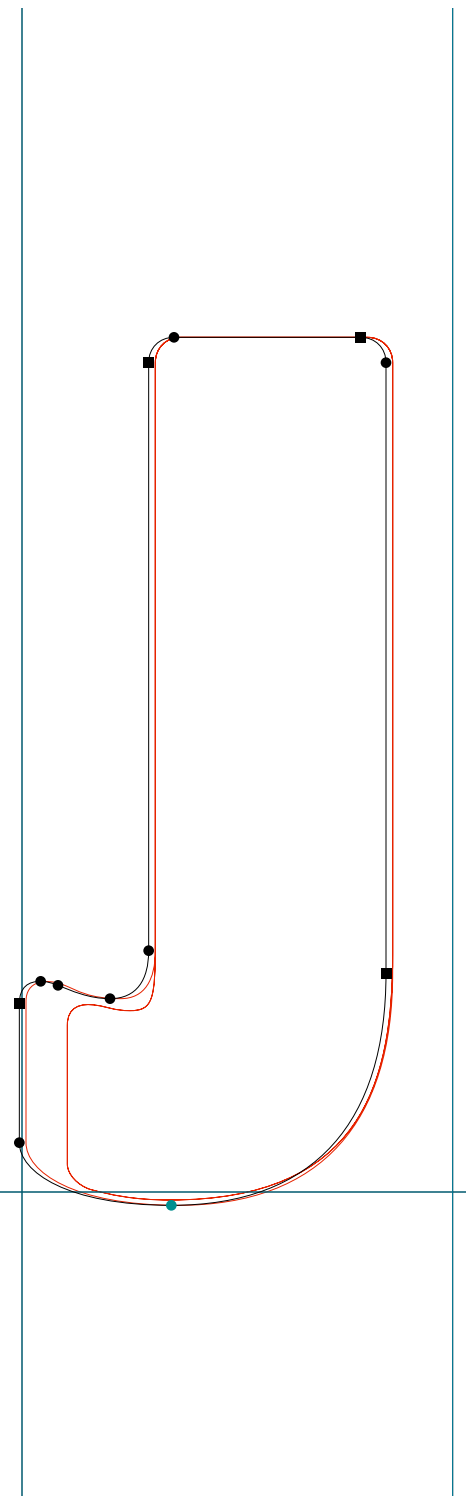

PROGRAM

.....
Program Bold | 0 | RoboFog Sketches | 2013 | Emigre Fonts

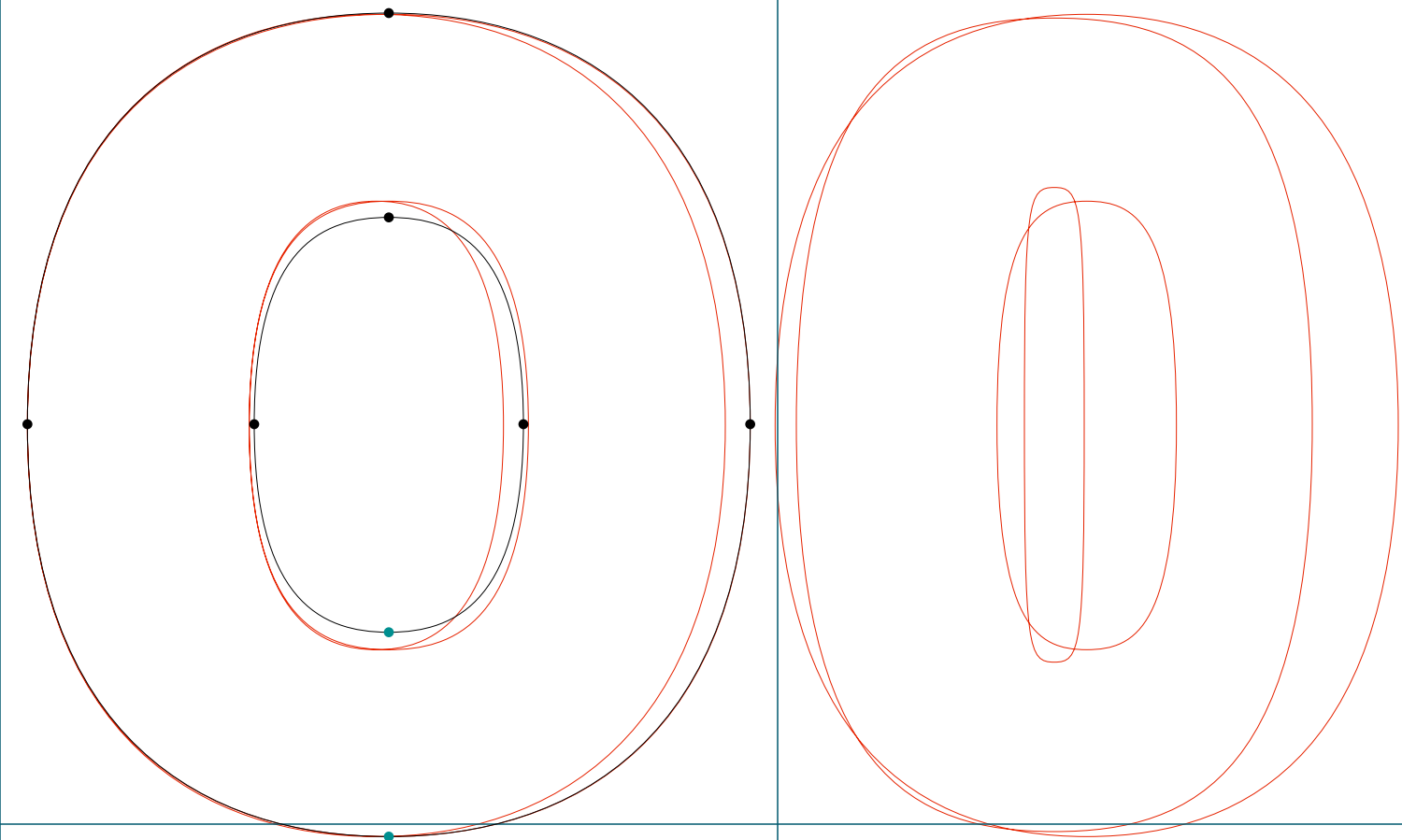

PROGRAM

.....
Program Bold | Q | RoboFog Sketches | 2013 | Emigre Fonts

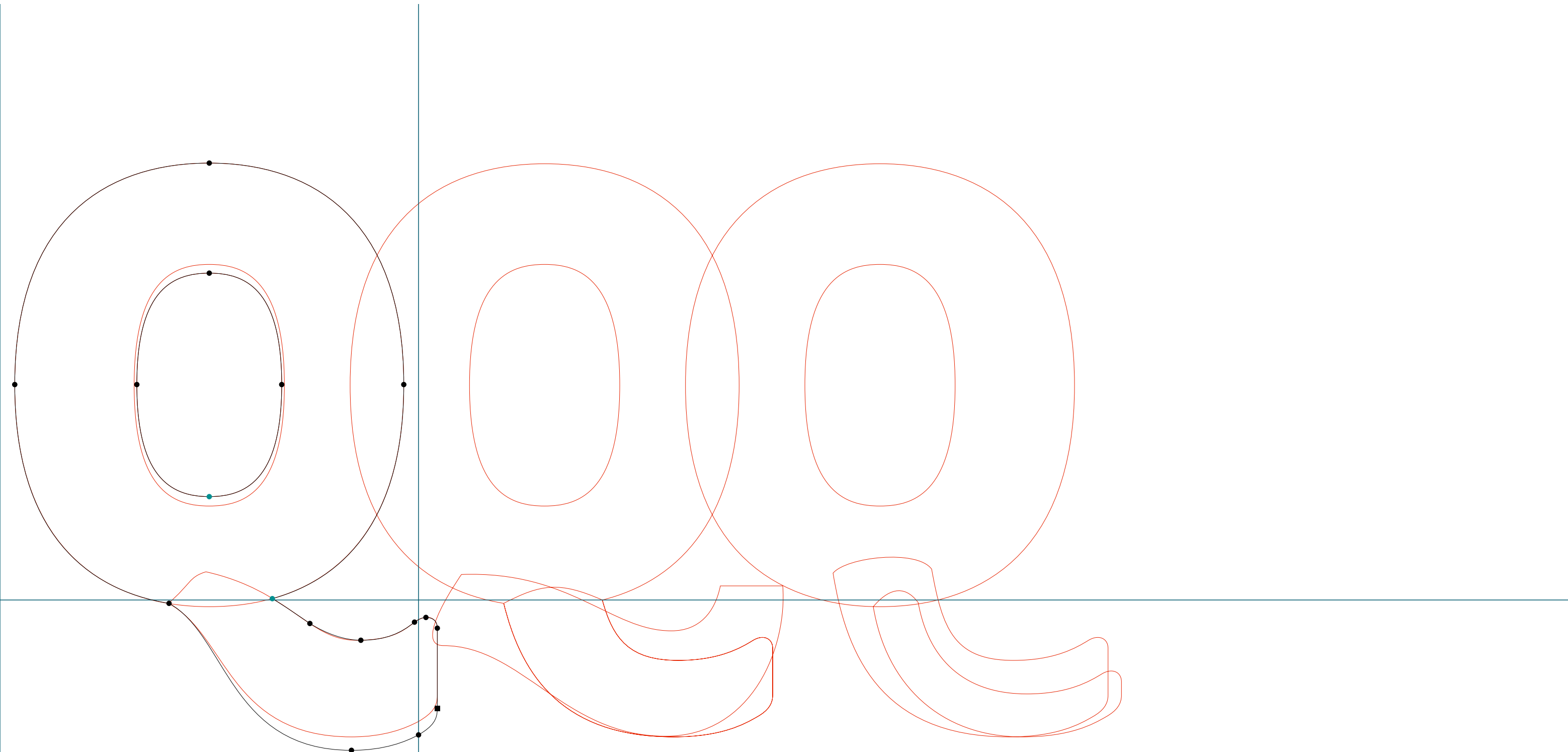

PROGRAM

.....
Program Bold | S | RoboFog Sketches | 2013 | Emigre Fonts

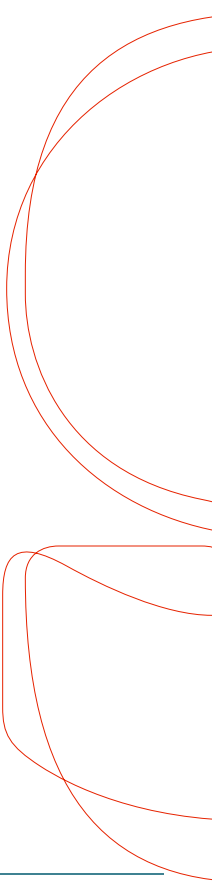
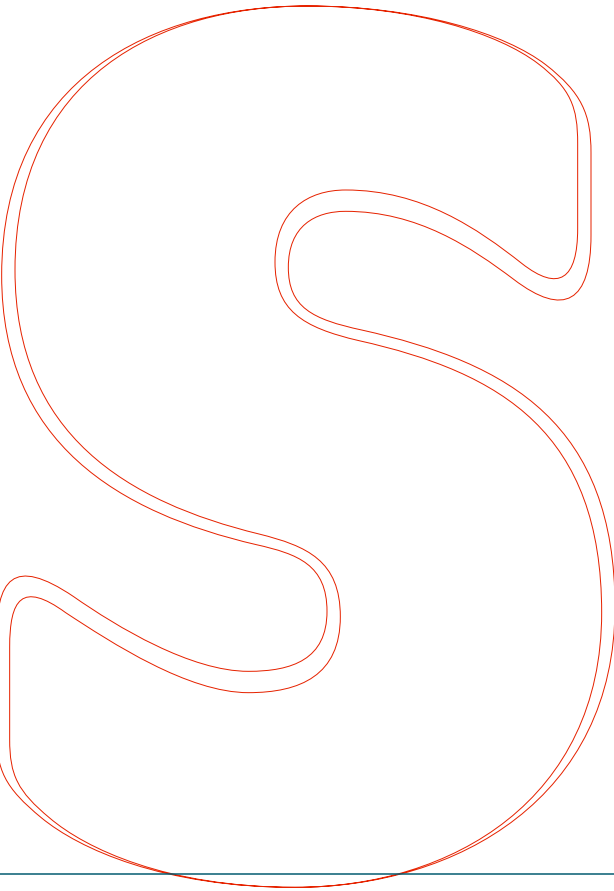
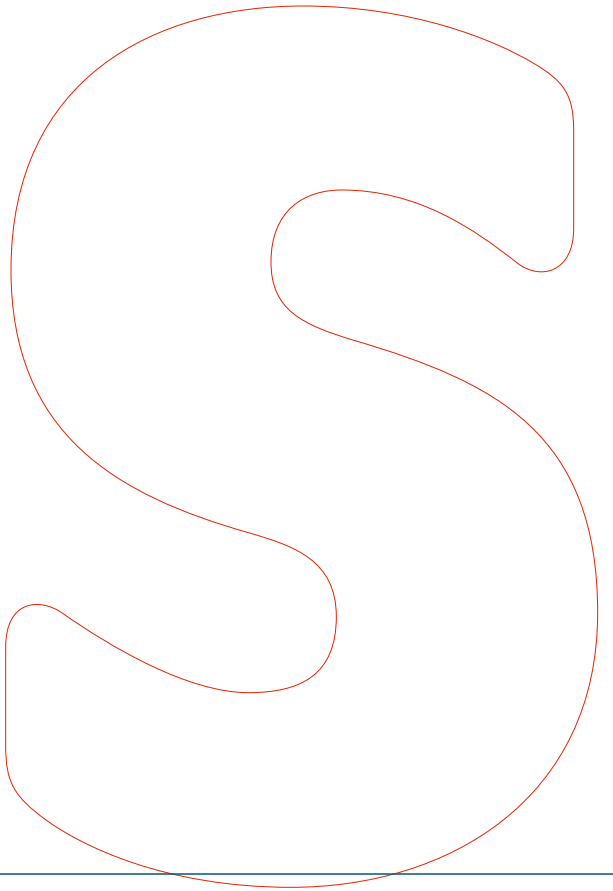
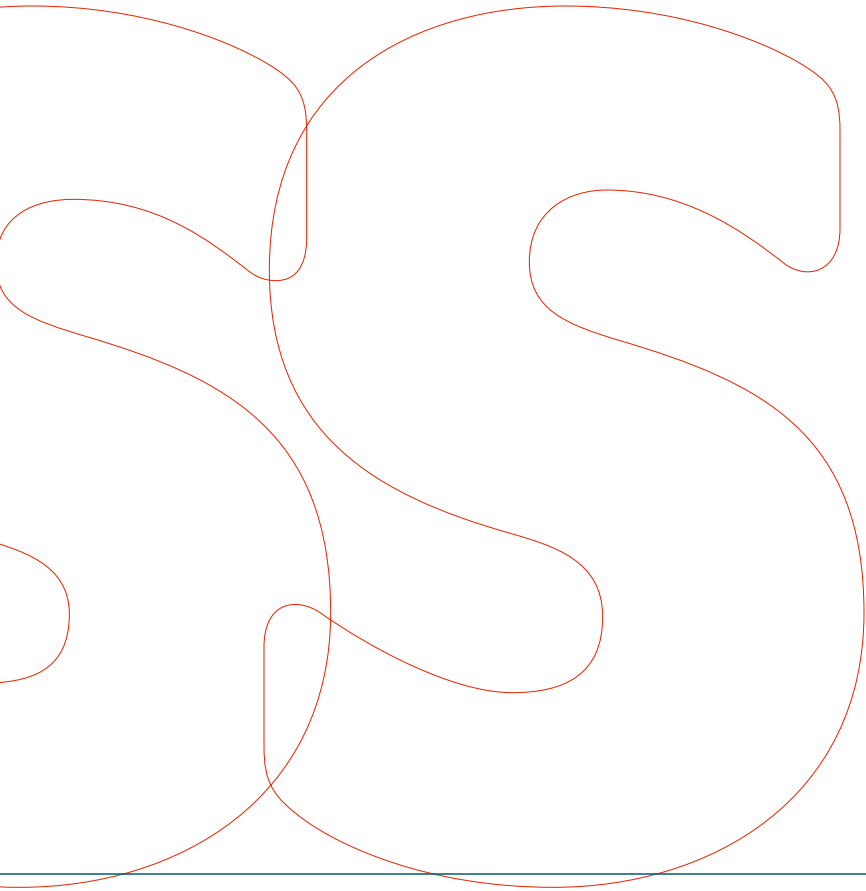
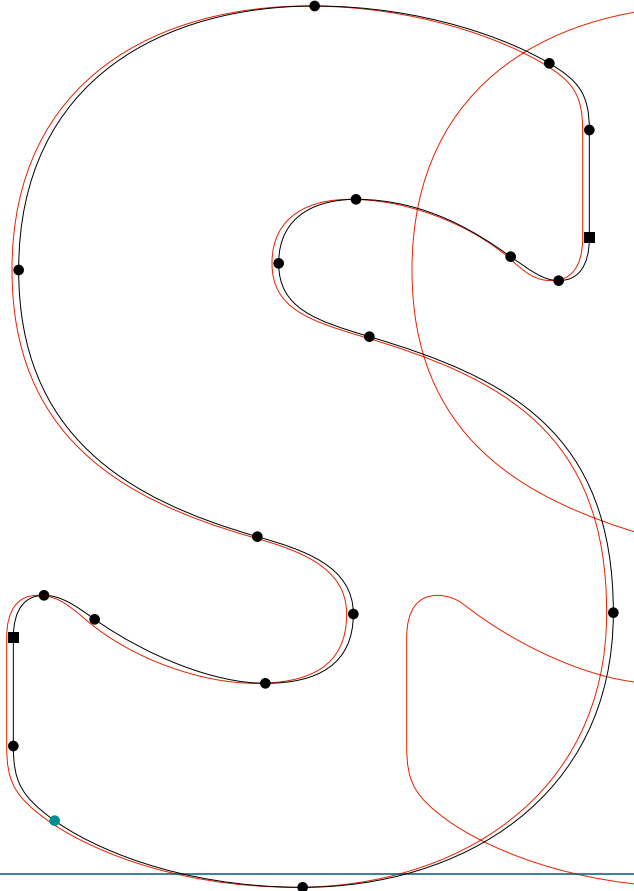
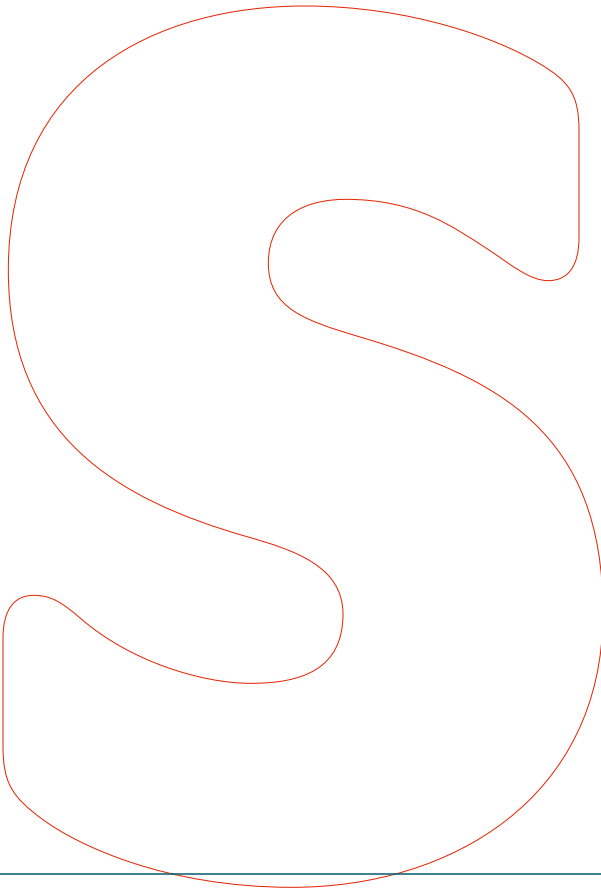

PROGRAM

Program Bold | W | RoboFog Sketches | 2013 | Emigre Fonts

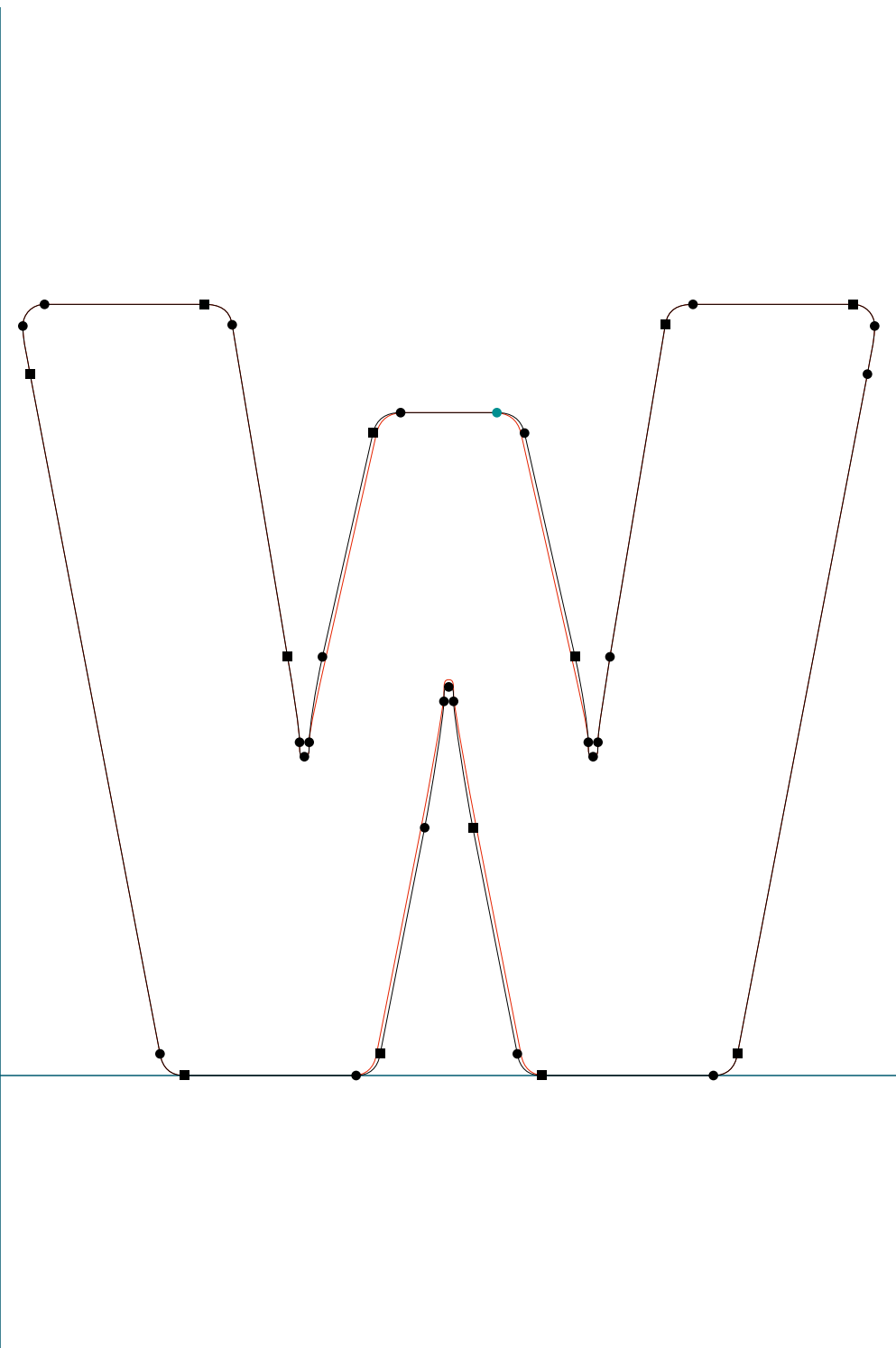

PROGRAM

.....
Program Bold | asciiircum | RoboFog Sketches | 2013 | Emigre Fonts

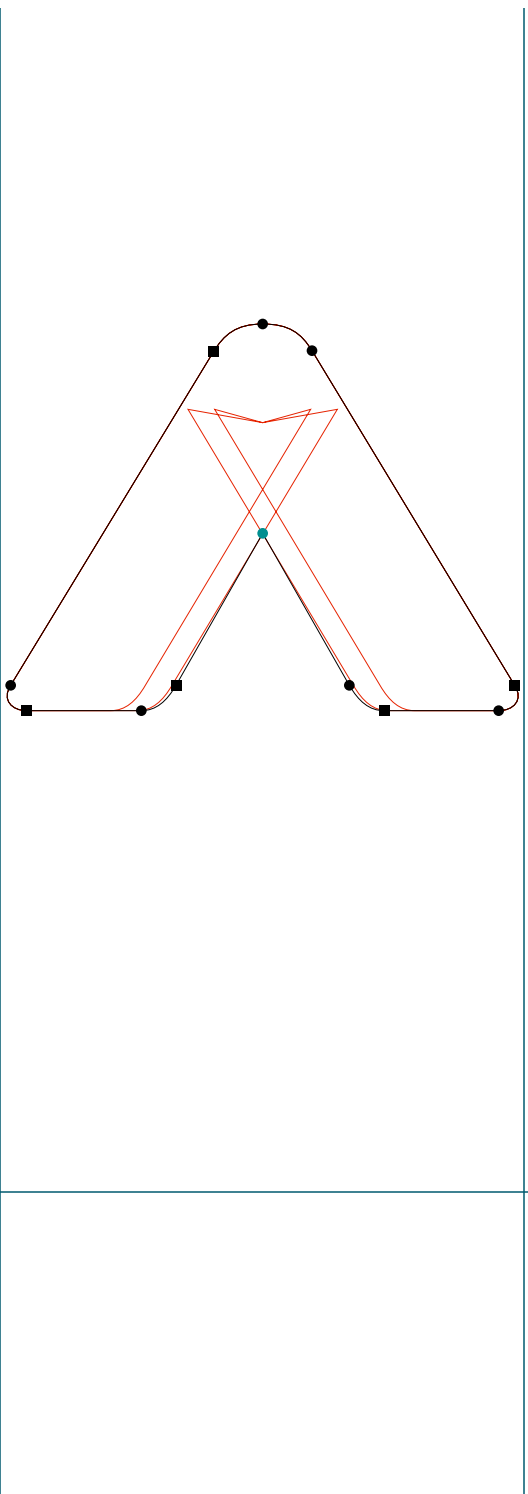

PROGRAM

.....
Program Bold | a | RoboFog Sketches | 2013 | Emigre Fonts

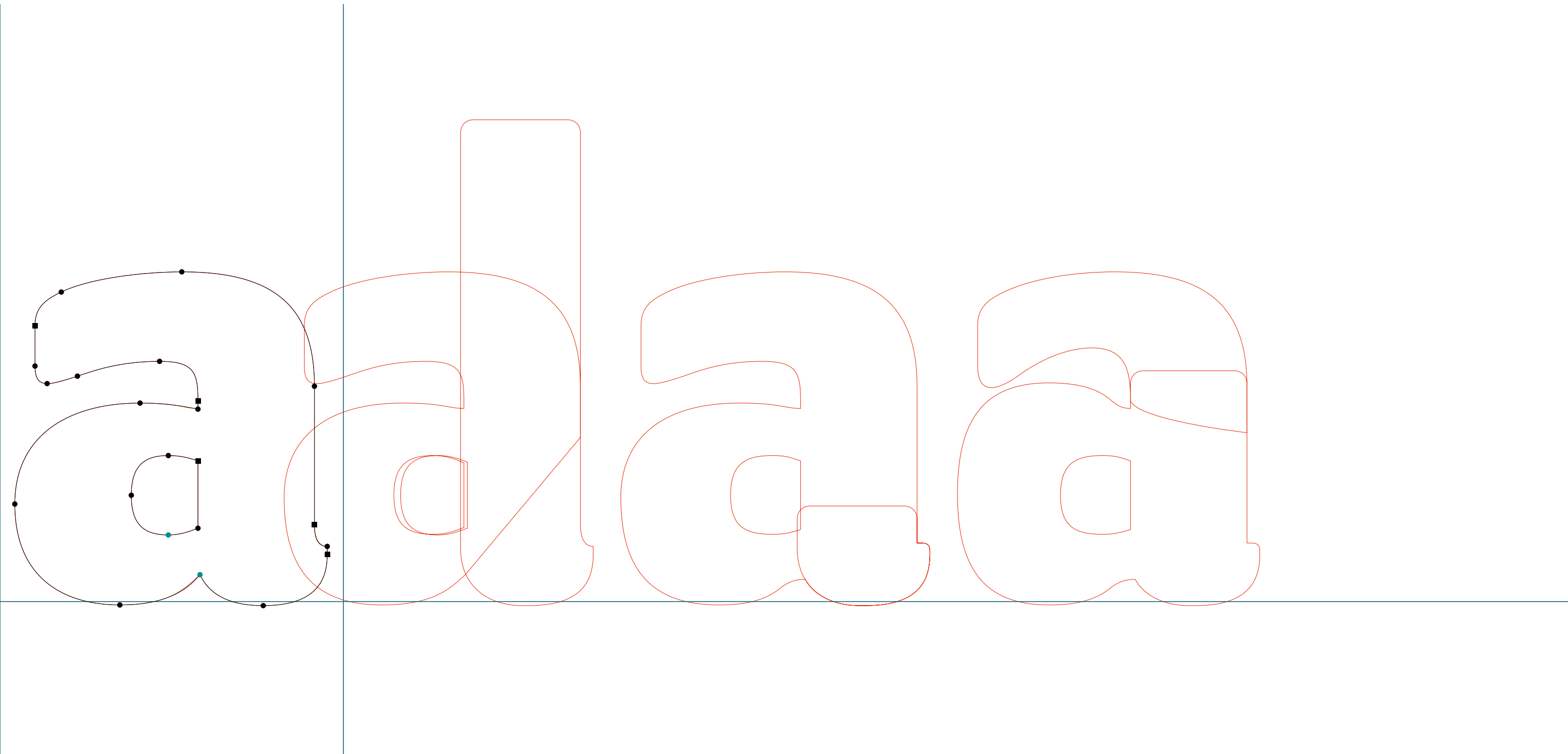

PROGRAM

.....
Program Bold | b | RoboFog Sketches | 2013 | Emigre Fonts

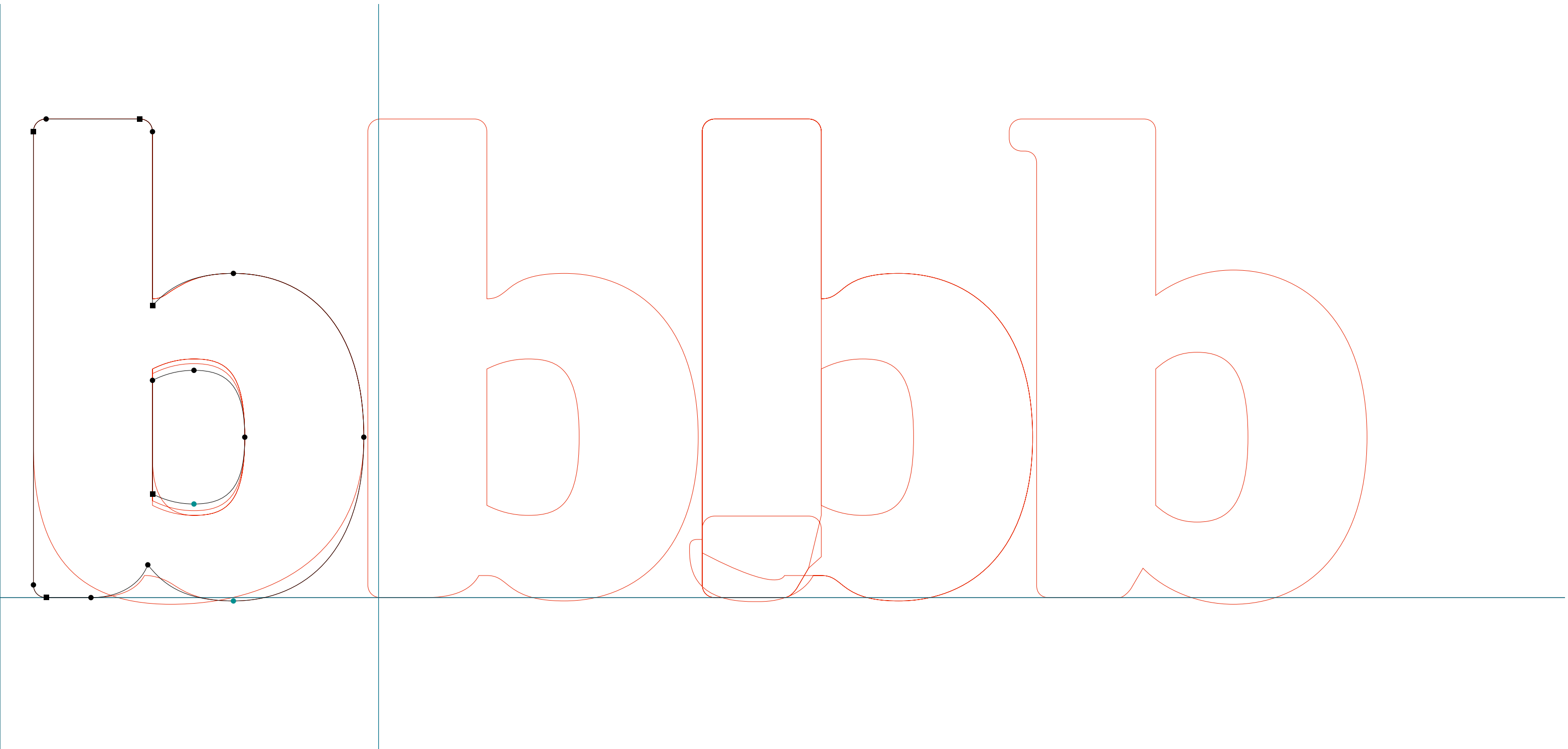

PROGRAM

.....
Program Bold | c | RoboFog Sketches | 2013 | Emigre Fonts

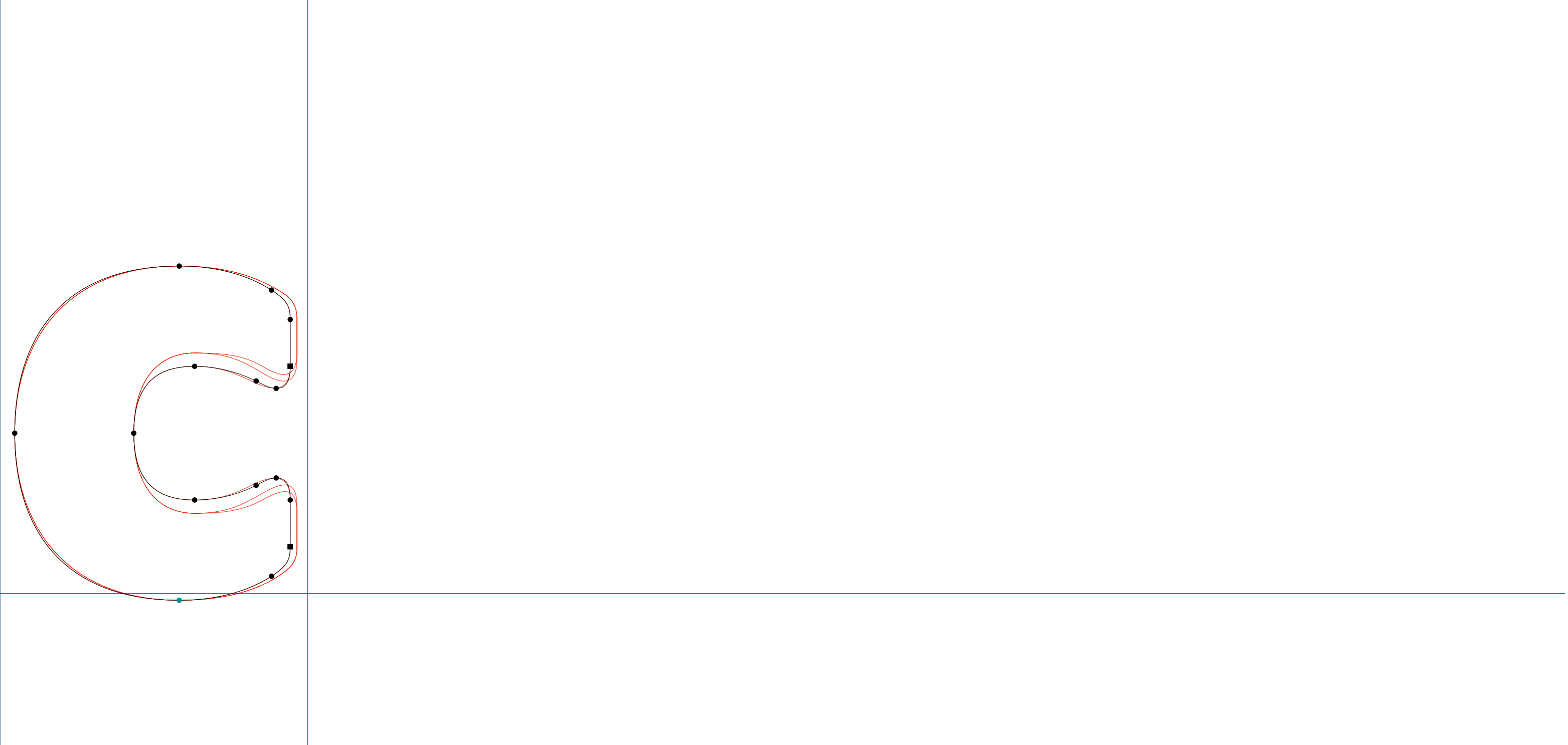

PROGRAM

.....
Program Bold | d | RoboFog Sketches | 2013 | Emigre Fonts

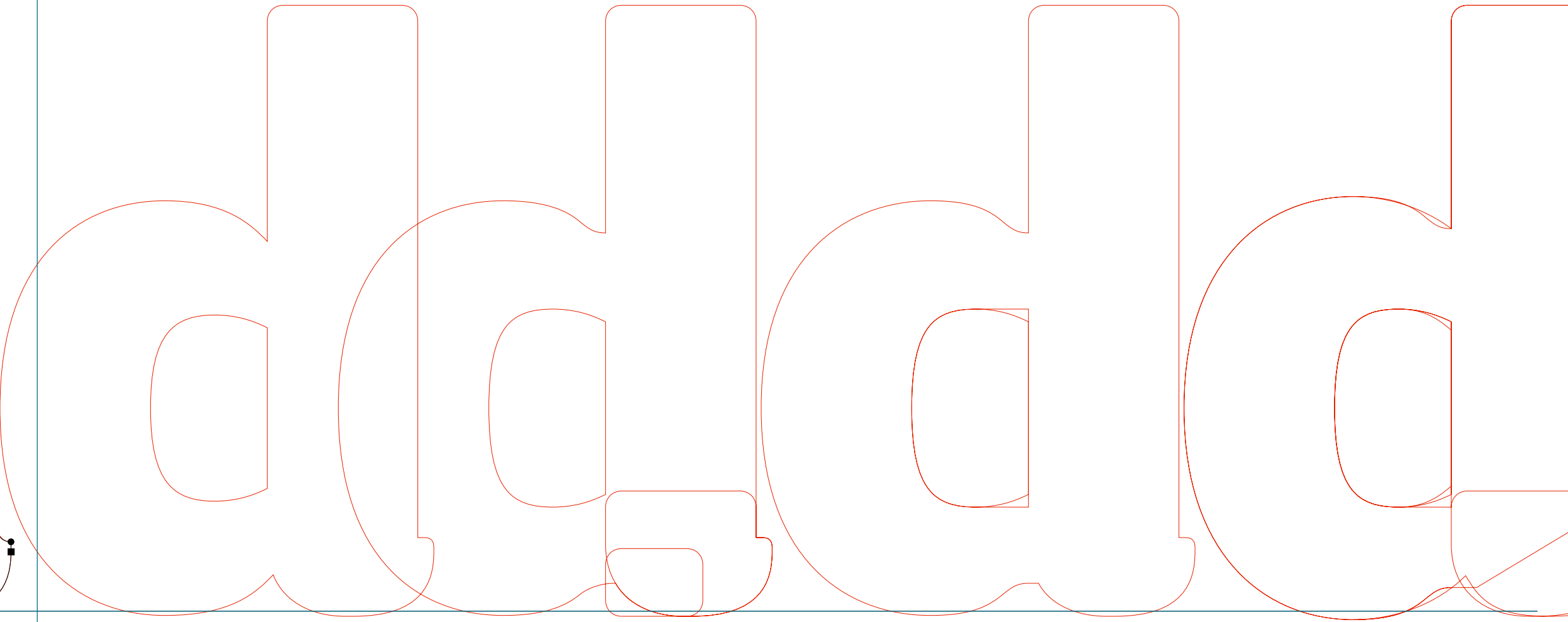
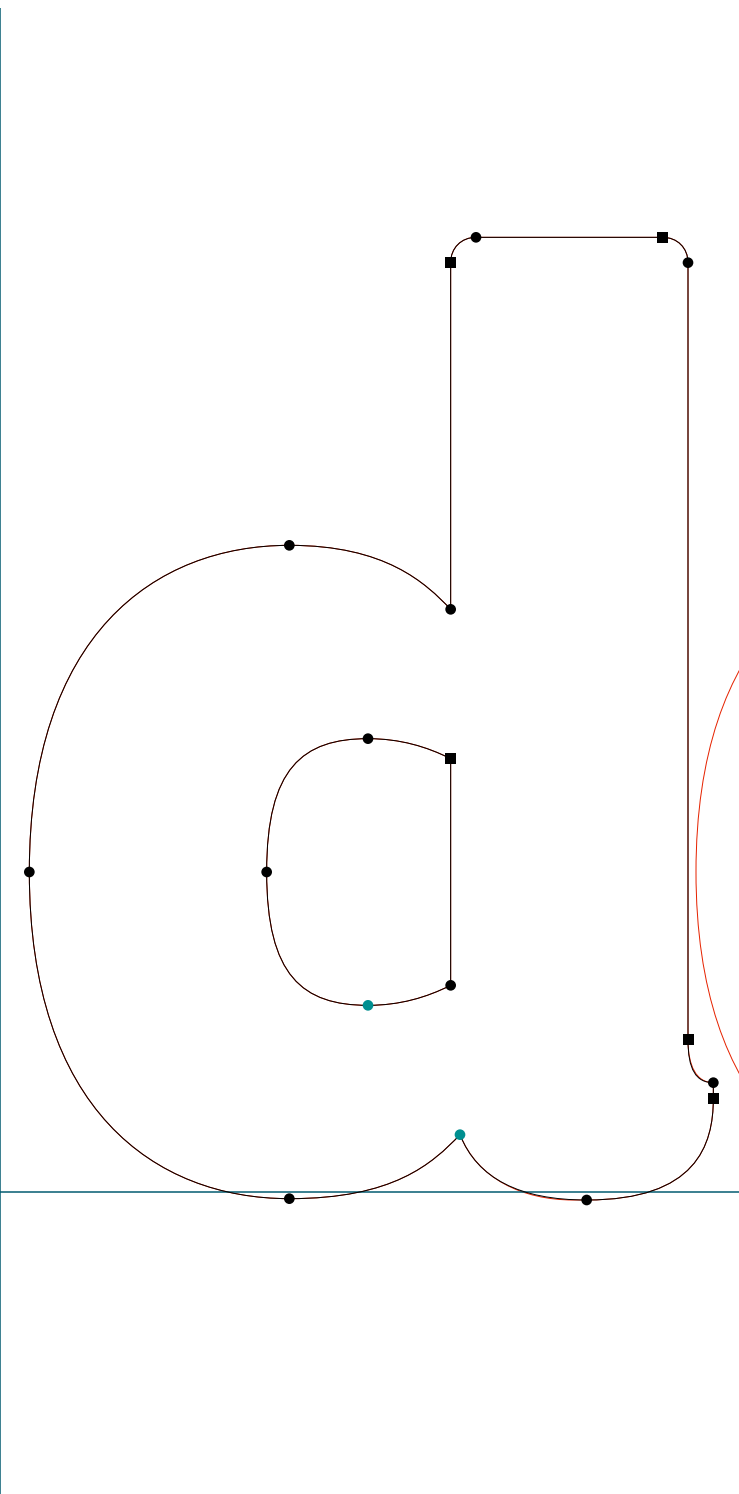

PROGRAM

.....
Program Bold | e | RoboFog Sketches | 2013 | Emigre Fonts

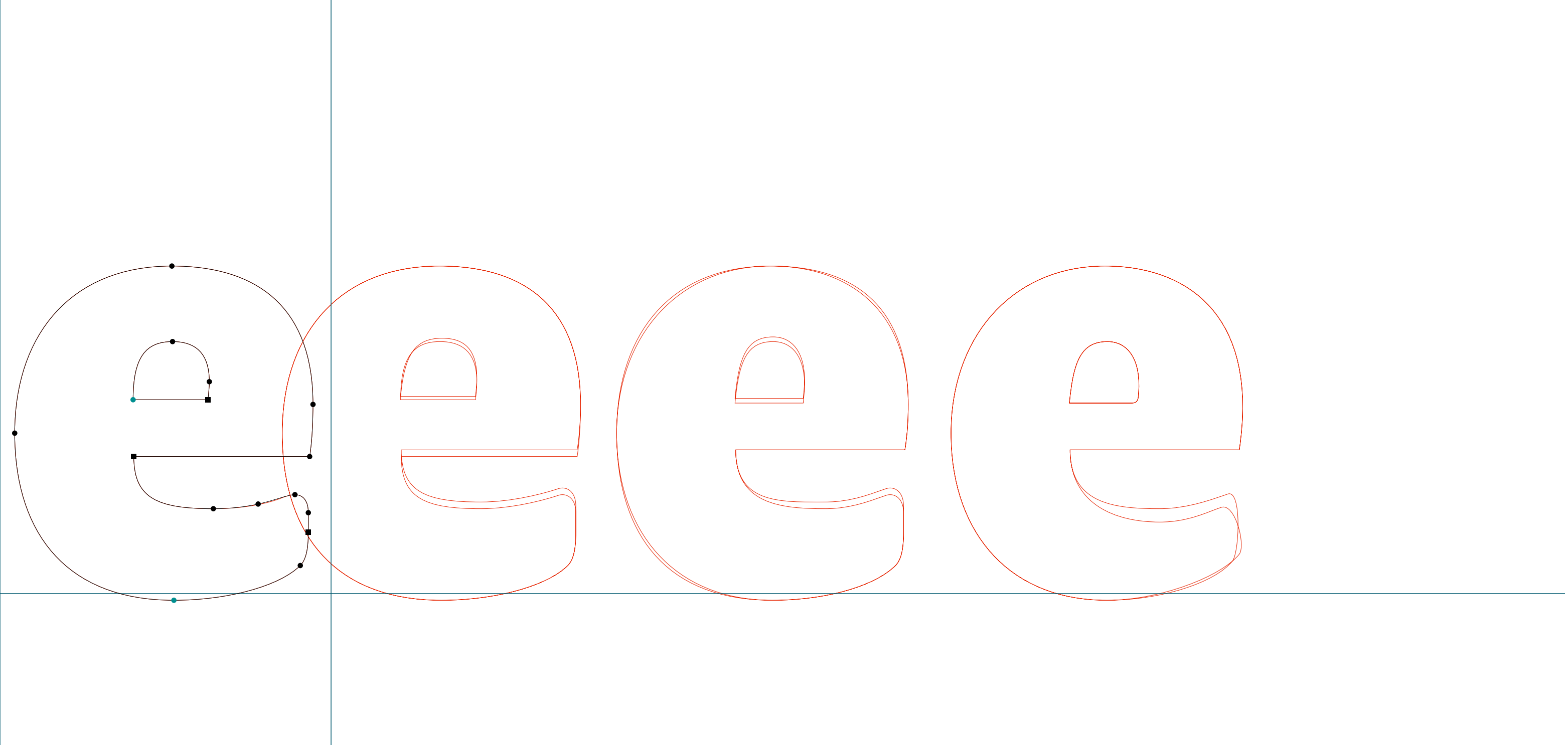

PROGRAM

Program Bold | f | RoboFog Sketches | 2013 | Emigre Fonts

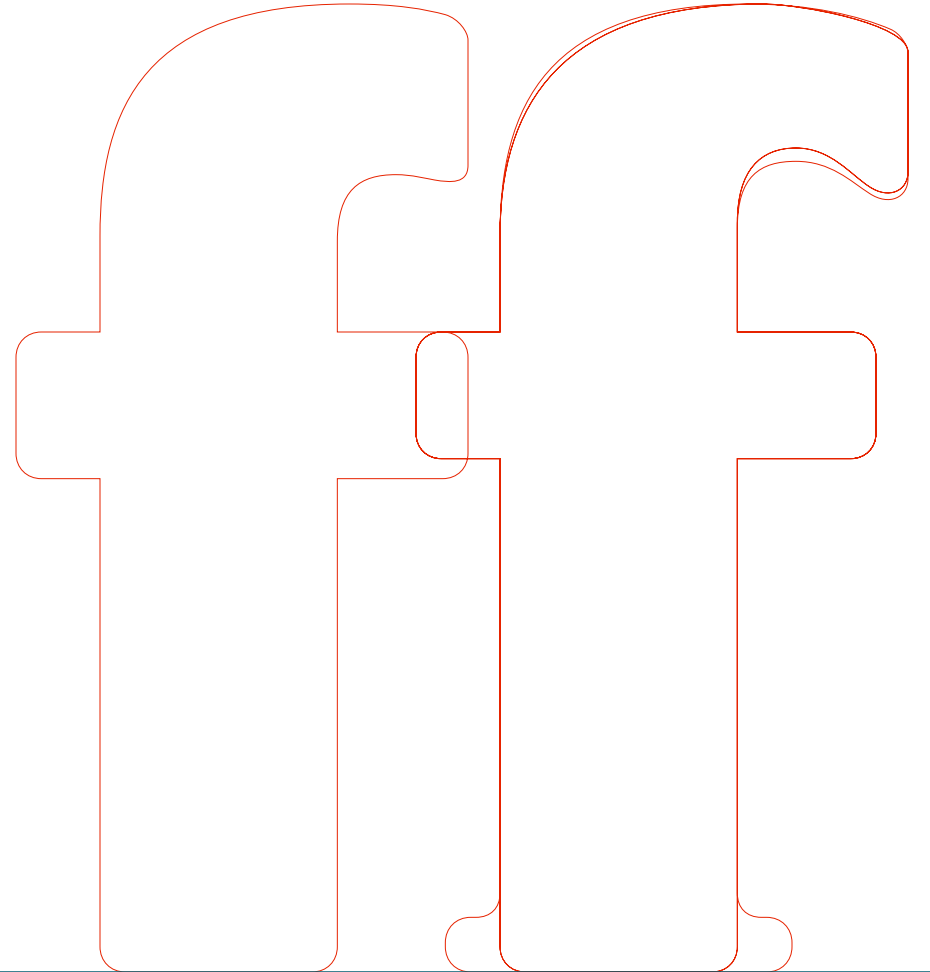
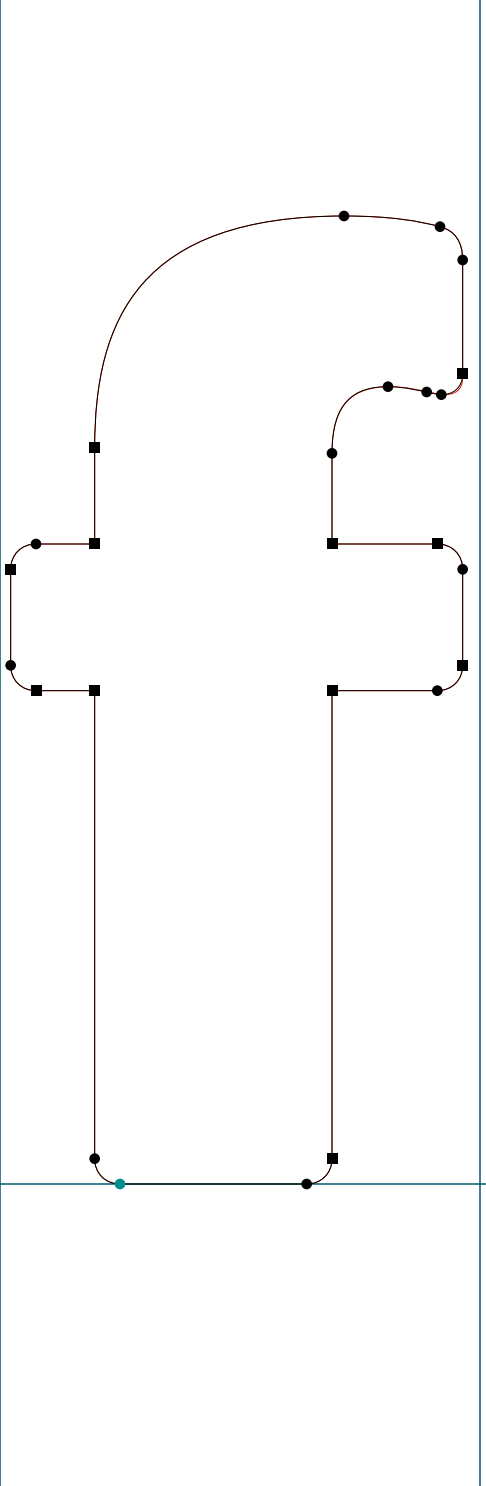

PROGRAM

Program Bold | g | RoboFog Sketches | 2013 | Emigre Fonts

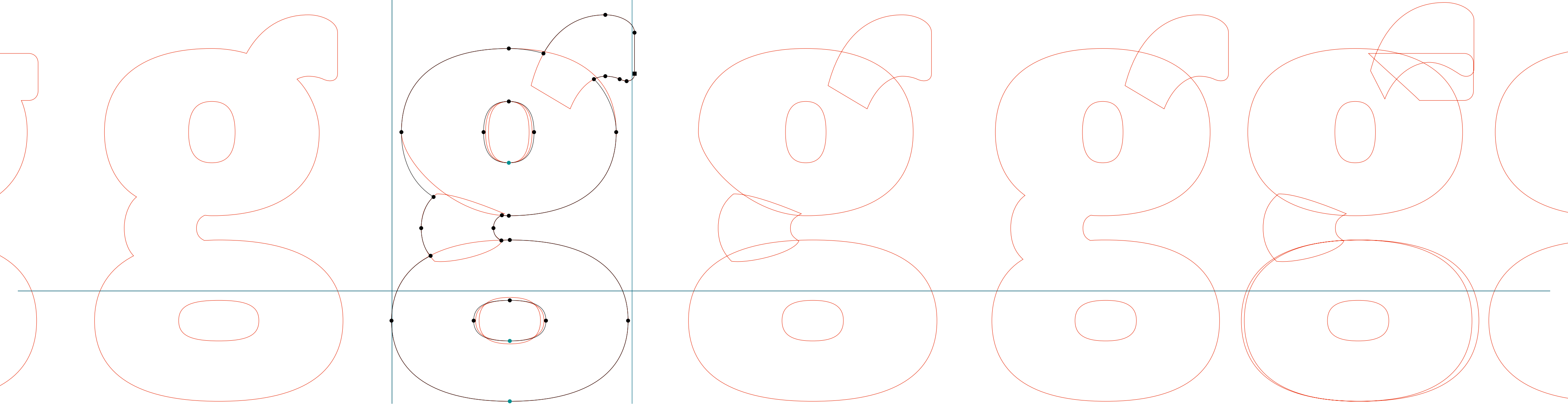

PROGRAM

.....
Program Bold | h | RoboFog Sketches | 2013 | Emigre Fonts

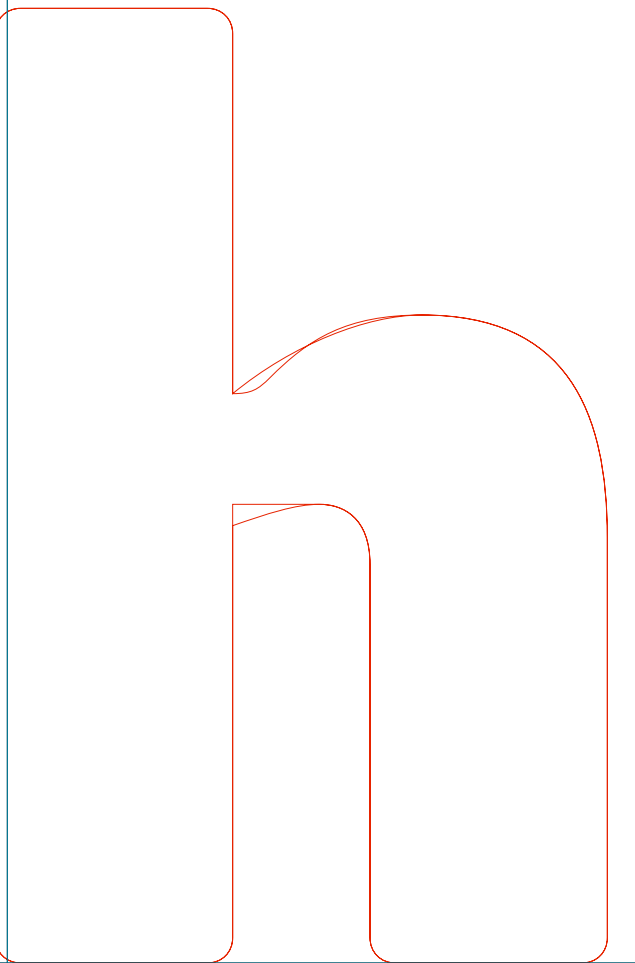
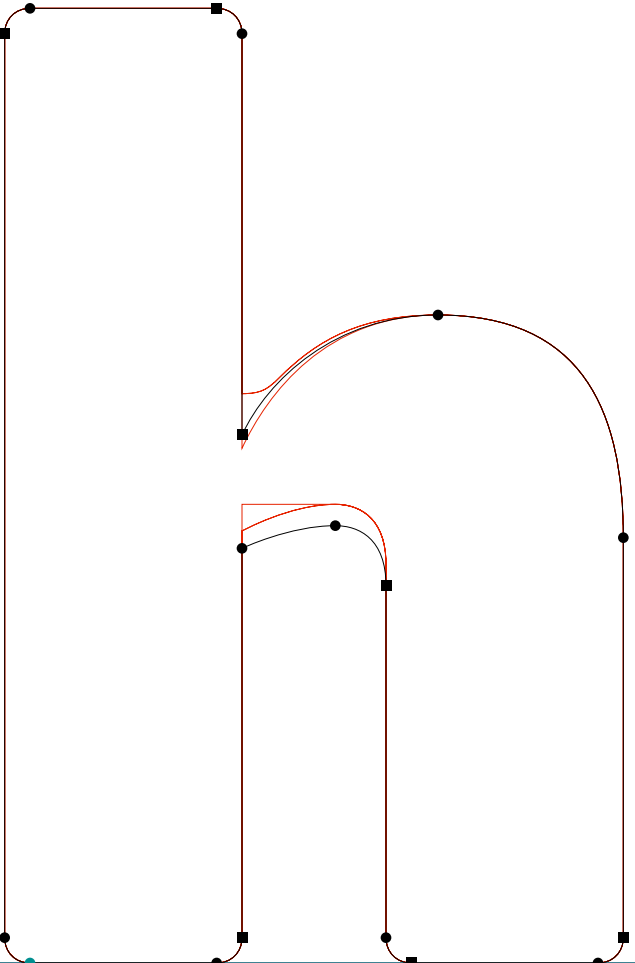

PROGRAM

.....
Program Bold | j | RoboFog Sketches | 2013 | Emigre Fonts

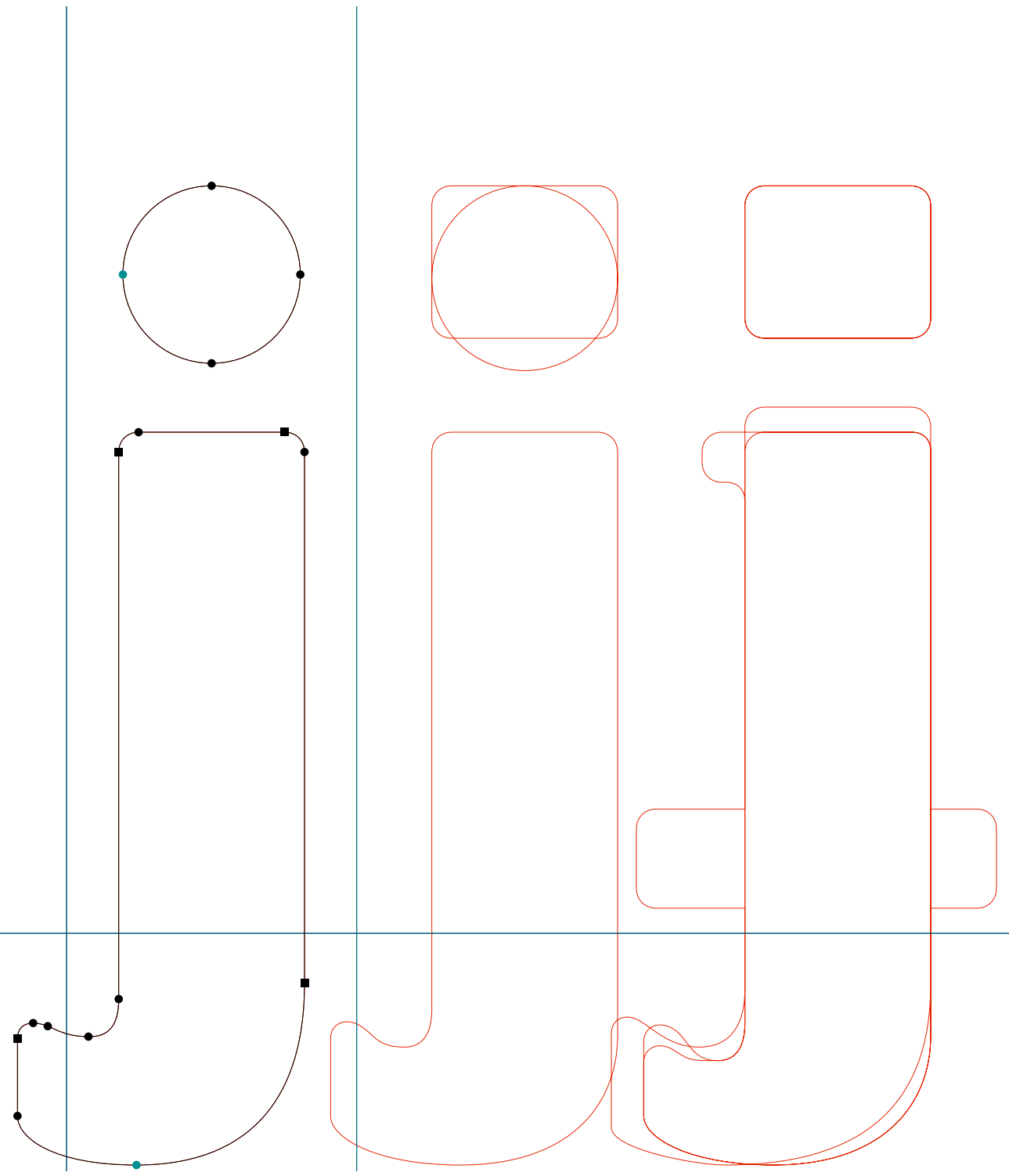

PROGRAM

.....
Program Bold | I | RoboFog Sketches | 2013 | Emigre Fonts

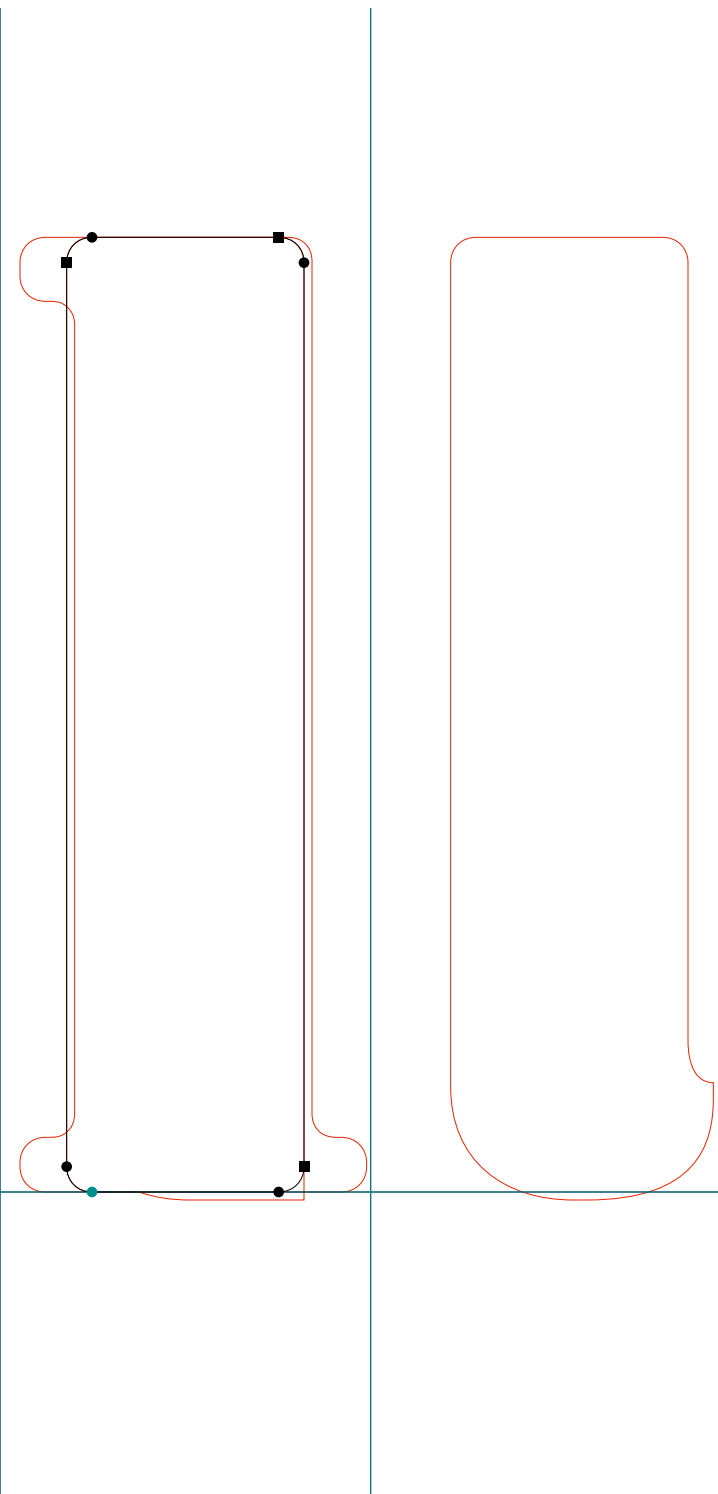

PROGRAM

.....
Program Bold | m | RoboFog Sketches | 2013 | Emigre Fonts

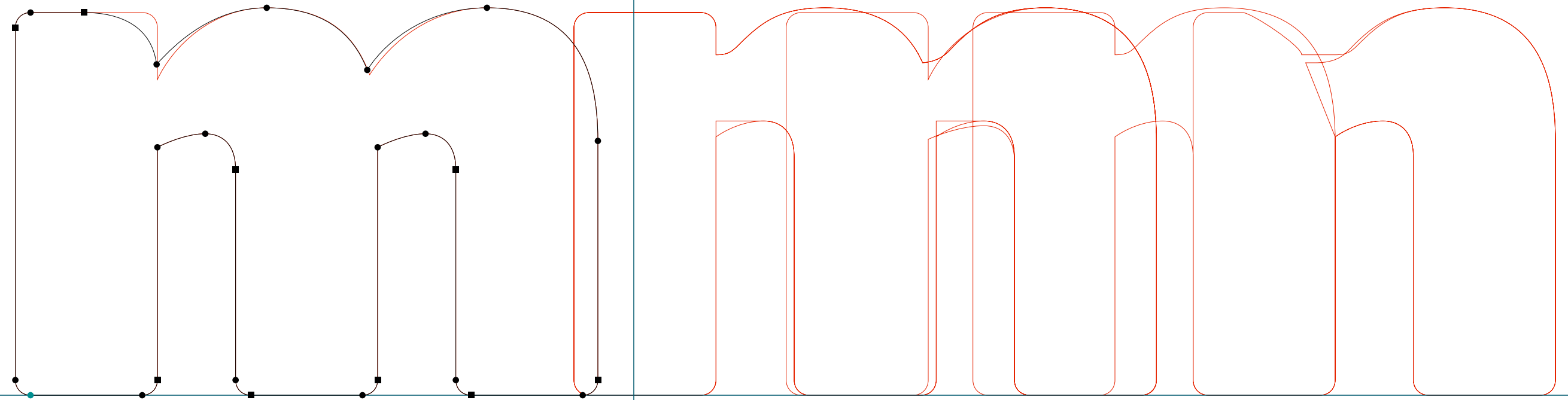

PROGRAM

.....
Program Bold | n | RoboFog Sketches | 2013 | Emigre Fonts

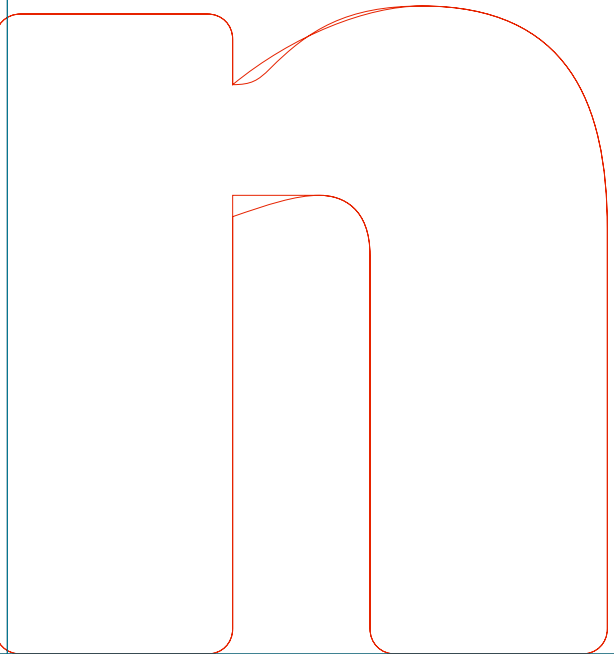
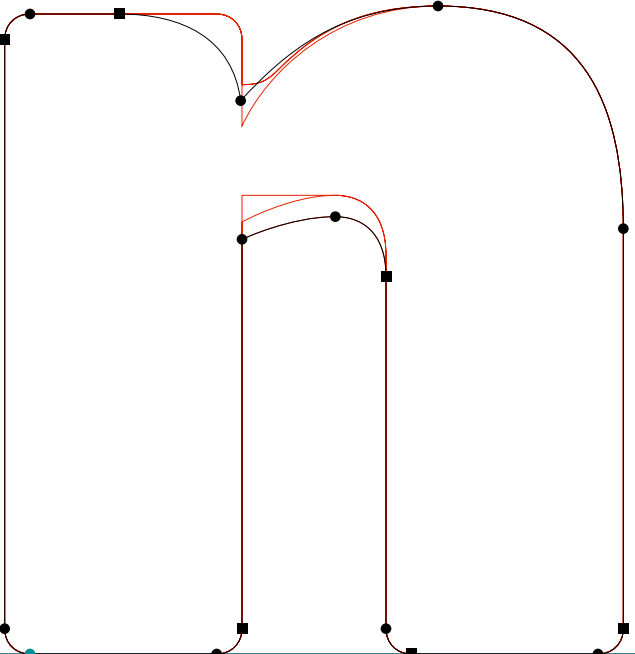

PROGRAM

.....
Program Bold | p | RoboFog Sketches | 2013 | Emigre Fonts

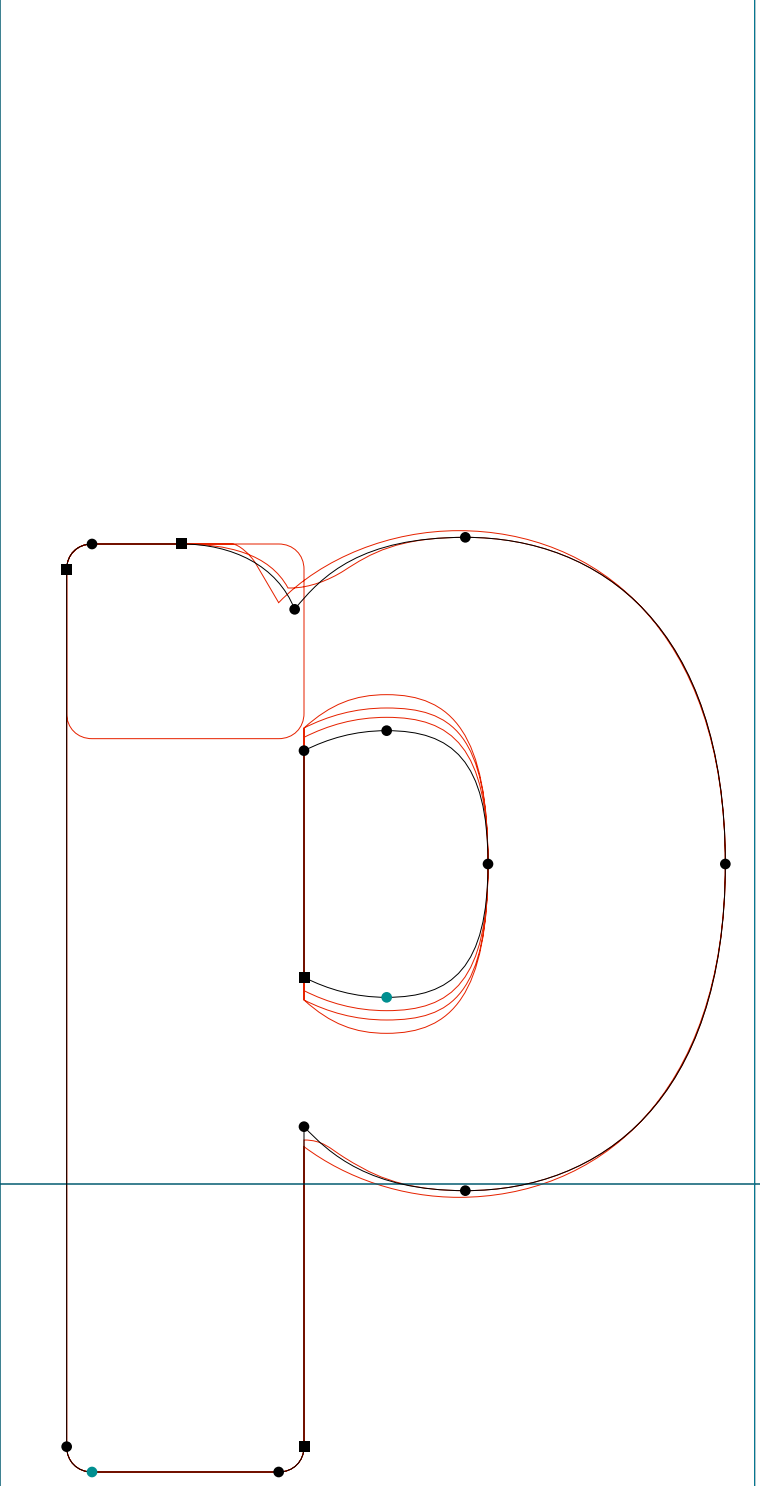

PROGRAM

.....
Program Bold | q | RoboFog Sketches | 2013 | Emigre Fonts

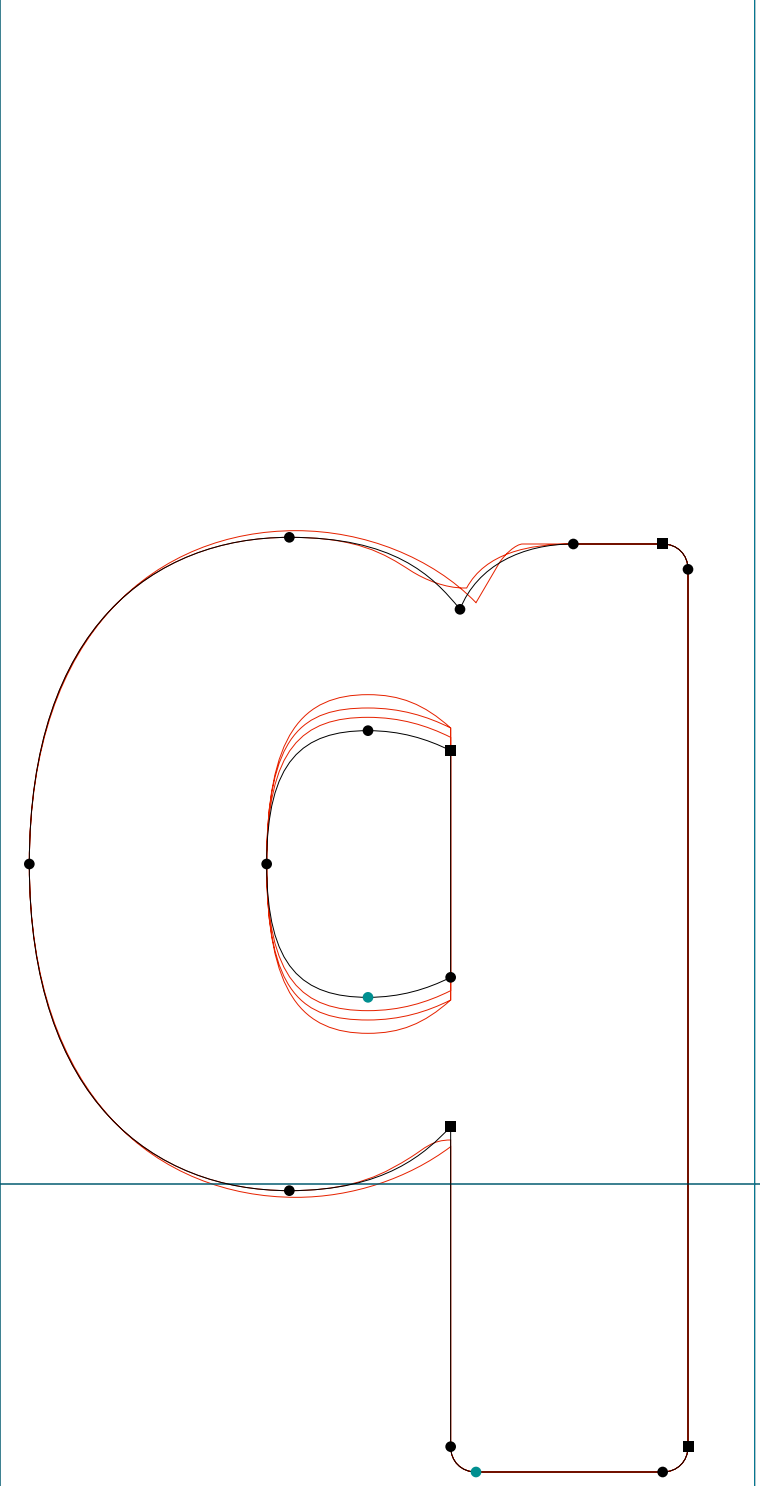

PROGRAM

Program Bold | r | RoboFog Sketches | 2013 | Emigre Fonts

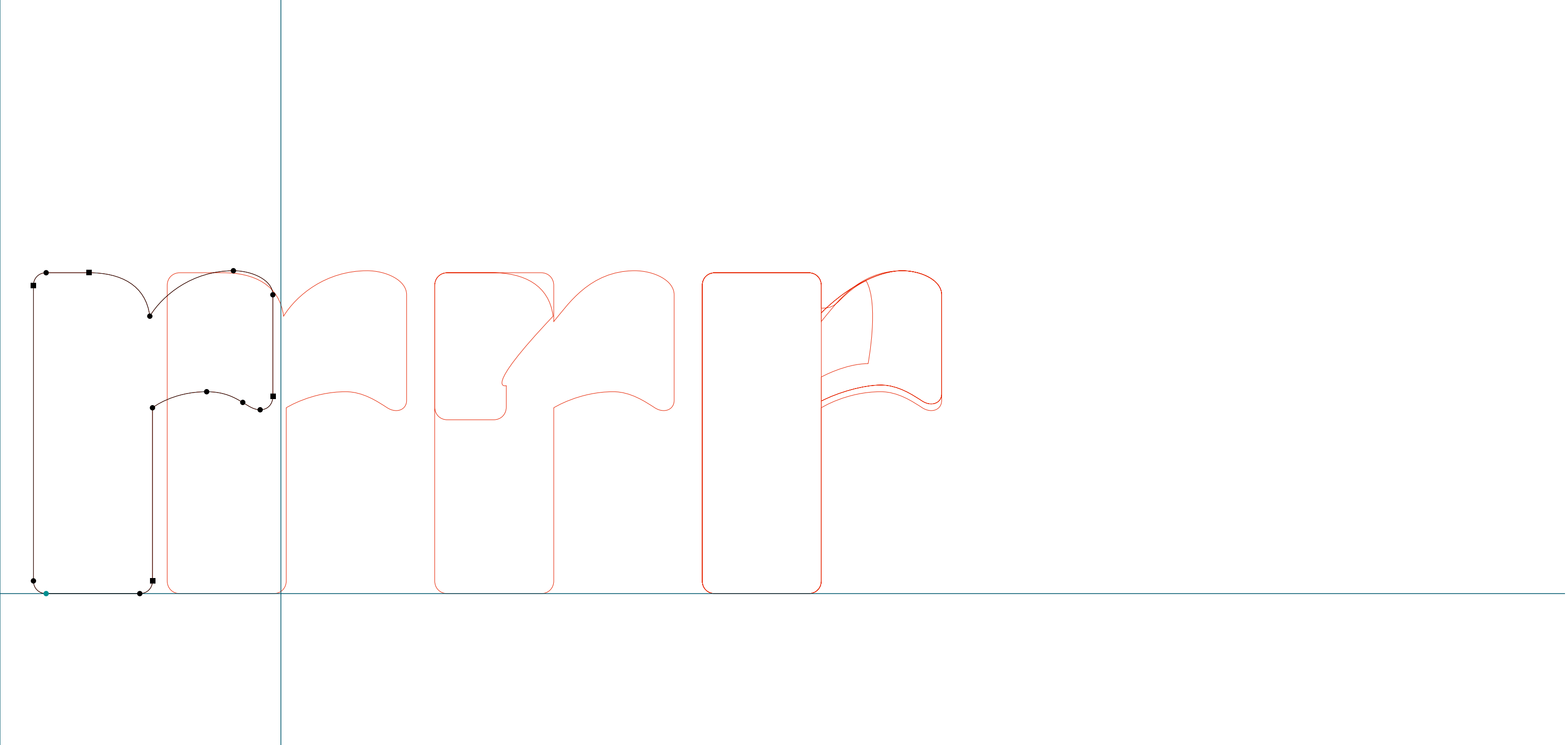

PROGRAM

Program Bold | s | RoboFog Sketches | 2013 | Emigre Fonts

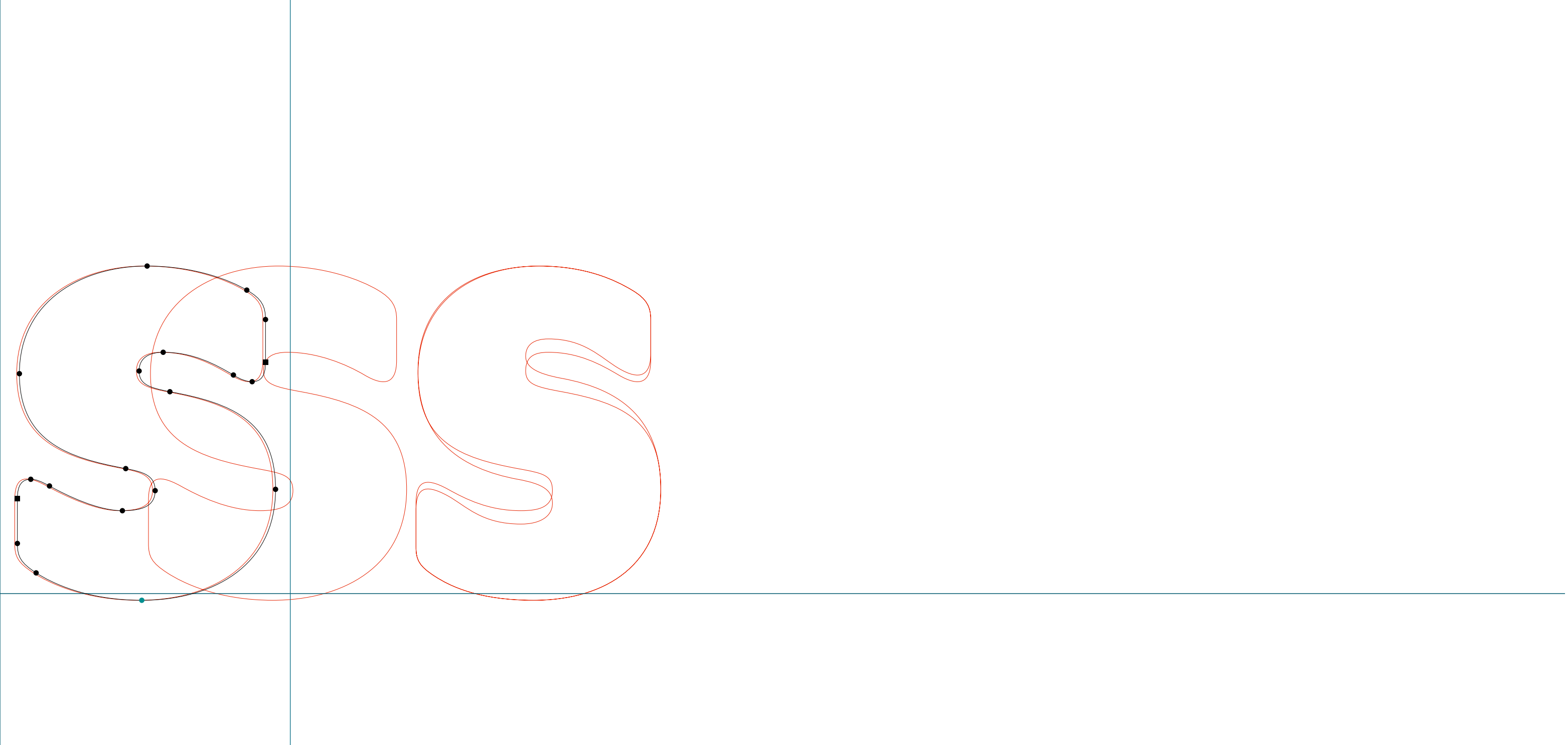

PROGRAM

Program Bold | t | RoboFog Sketches | 2013 | Emigre Fonts

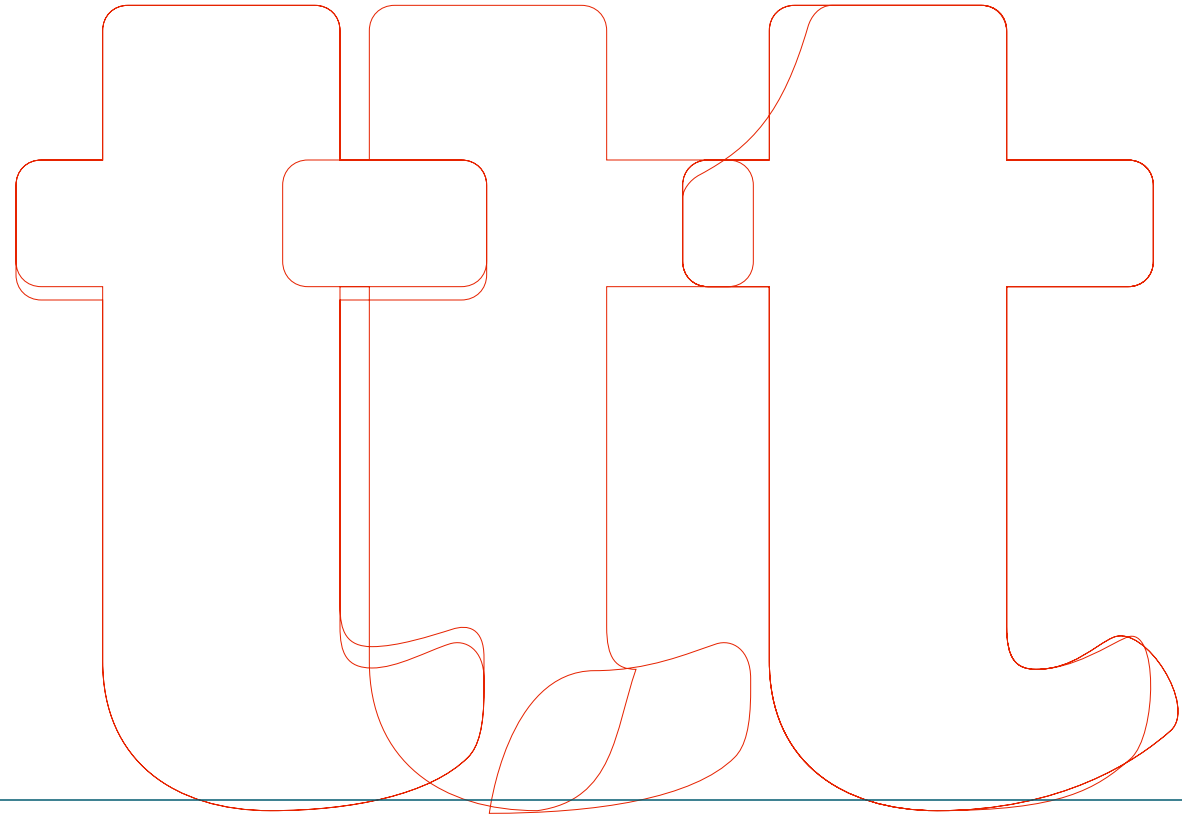
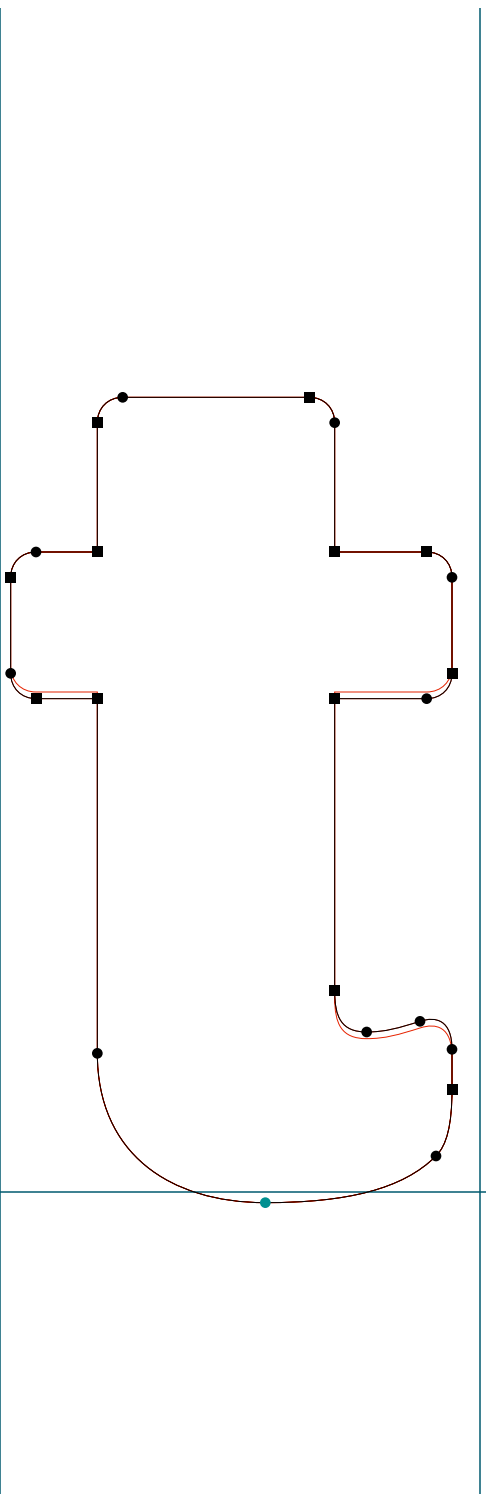

PROGRAM

.....
Program Bold | u | RoboFog Sketches | 2013 | Emigre Fonts

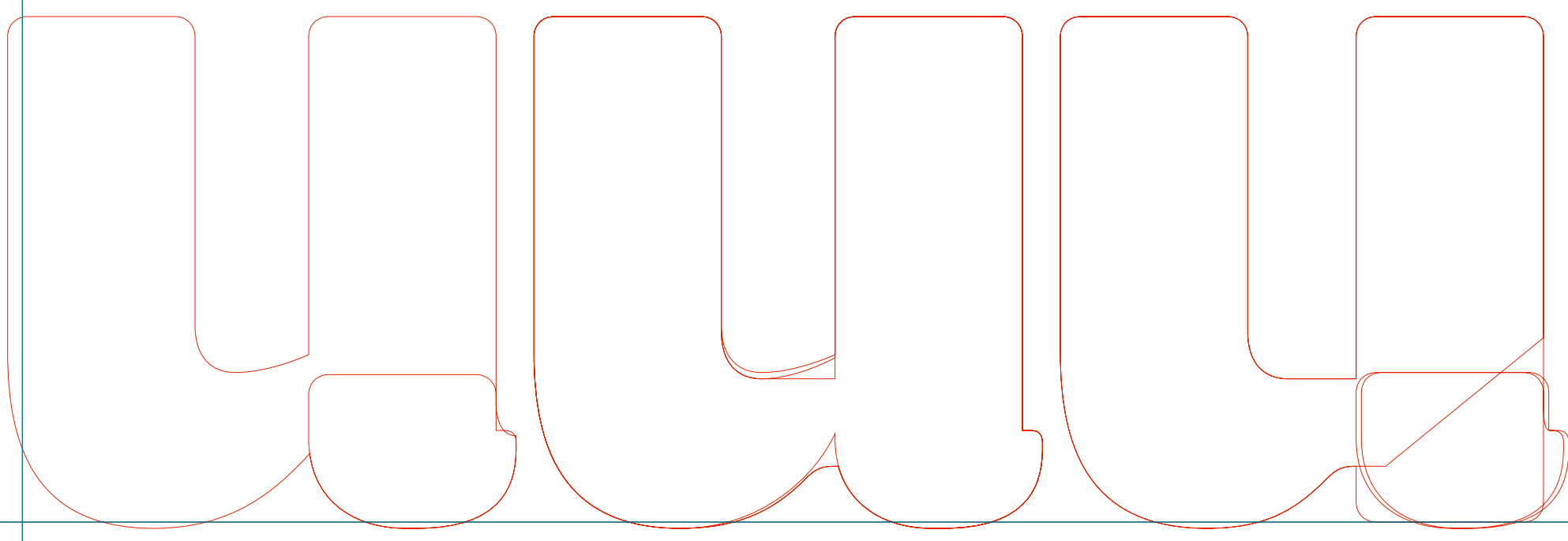
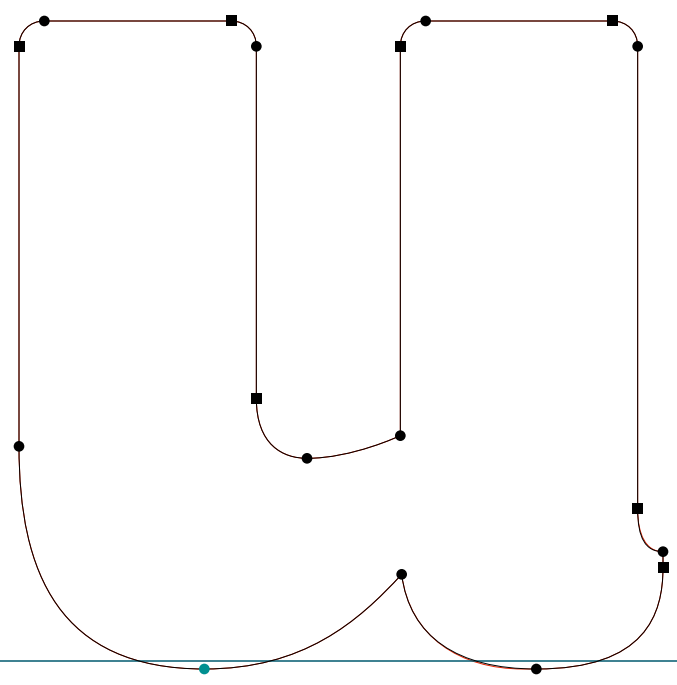

PROGRAM

.....
Program Bold | v | RoboFog Sketches | 2013 | Emigre Fonts



PROGRAM

Program Bold | w | RoboFog Sketches | 2013 | Emigre Fonts

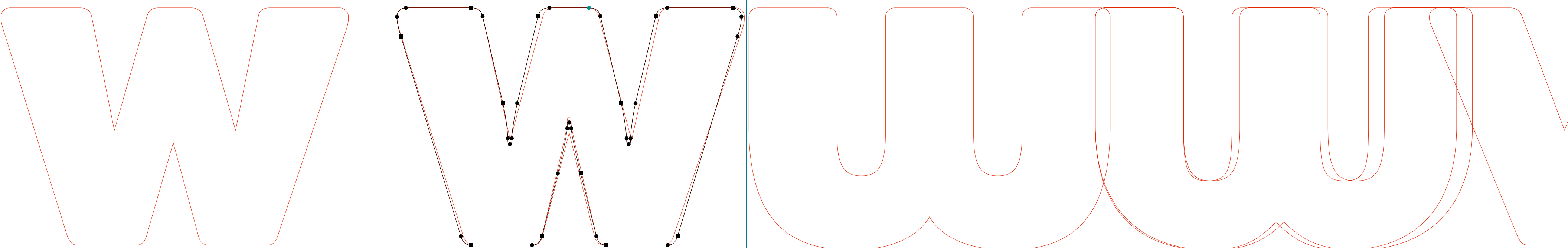

PROGRAM

.....
Program Bold | x | RoboFog Sketches | 2013 | Emigre Fonts

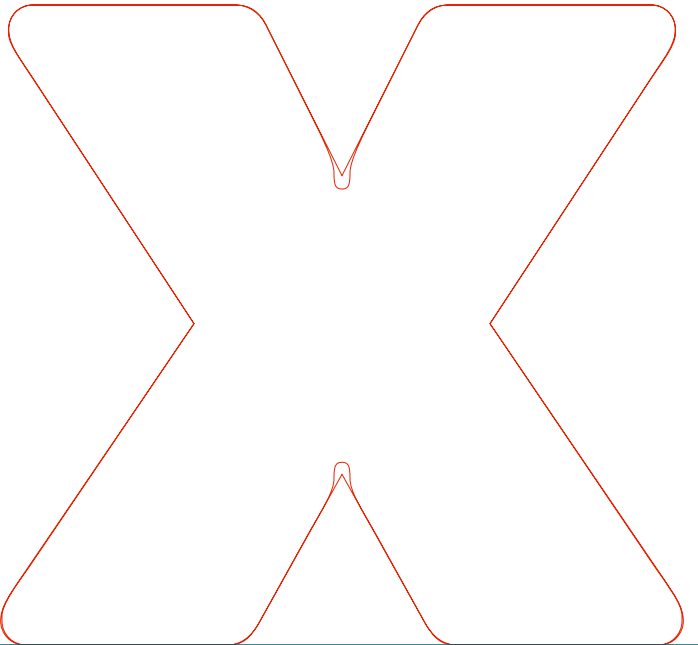
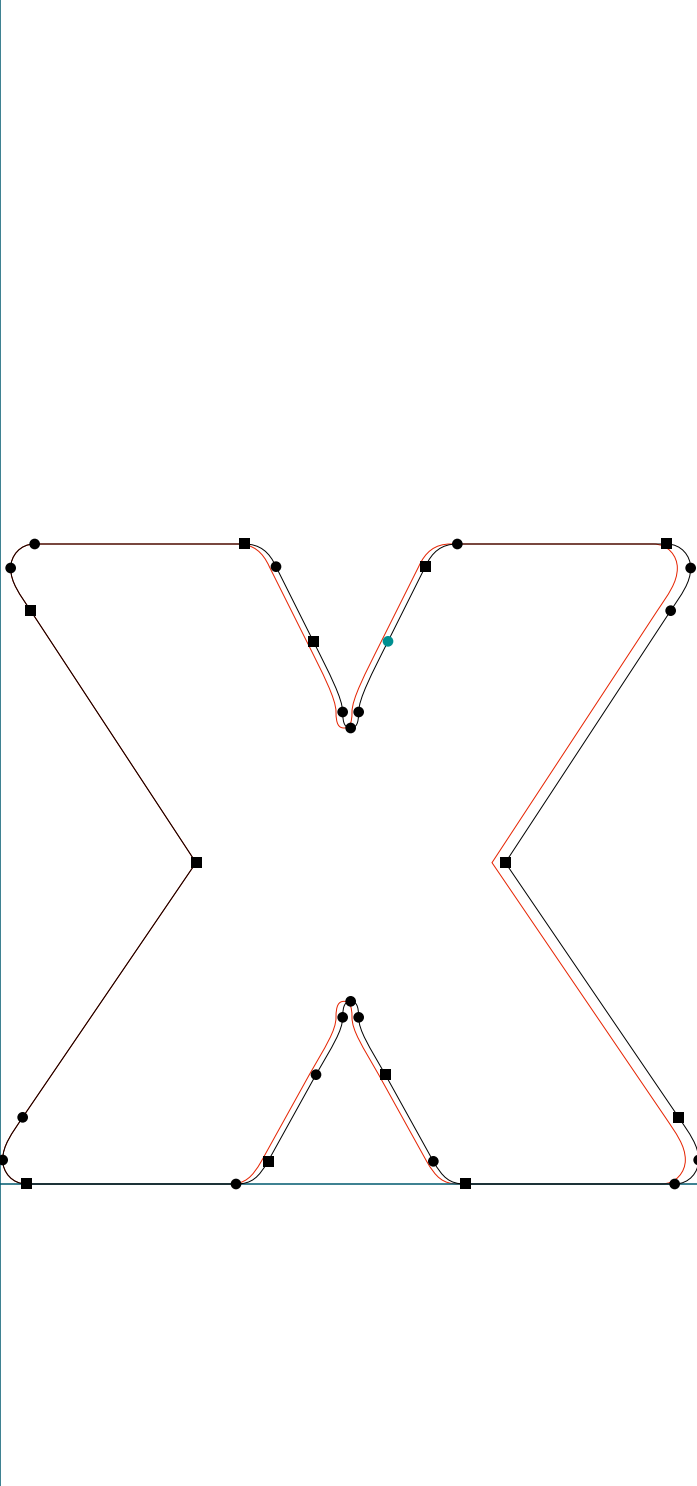

PROGRAM

.....
Program Bold | y | RoboFog Sketches | 2013 | Emigre Fonts

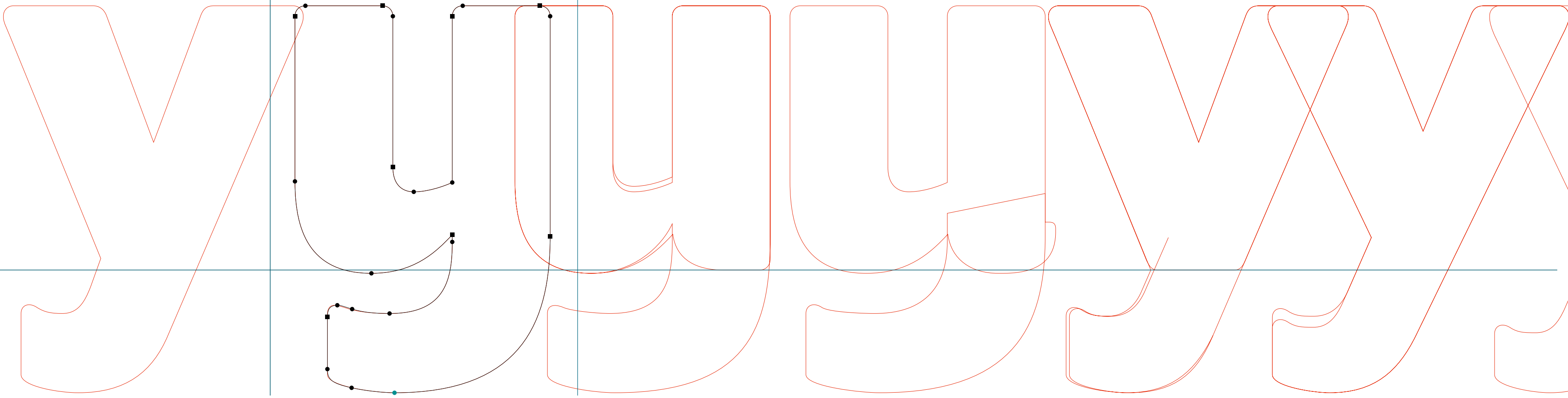

PROGRAM

.....
Program Bold | z | RoboFog Sketches | 2013 | Emigre Fonts

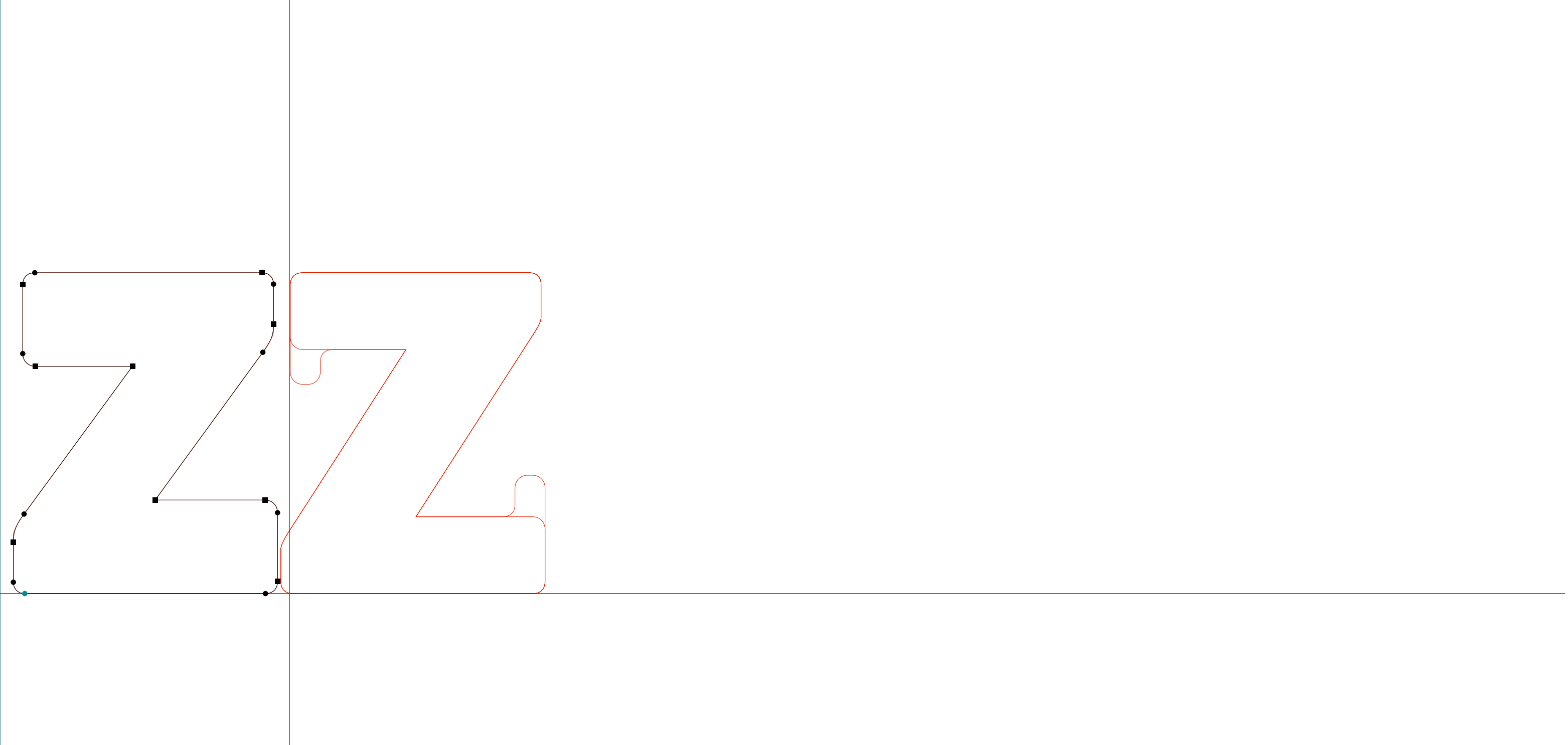

PROGRAM

.....
Program Bold | cent | RoboFog Sketches | 2013 | Emigre Fonts

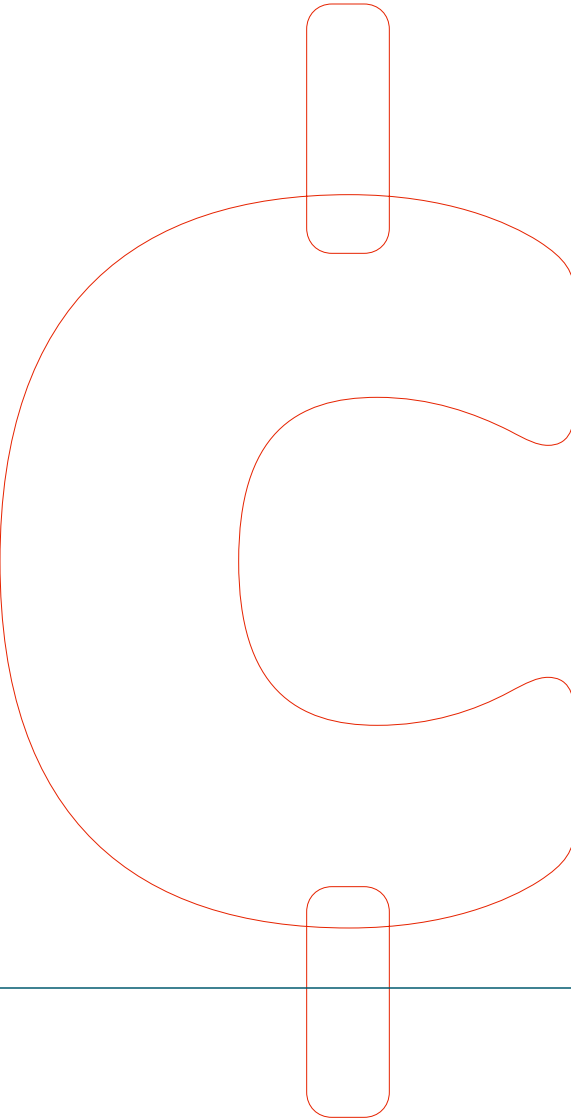
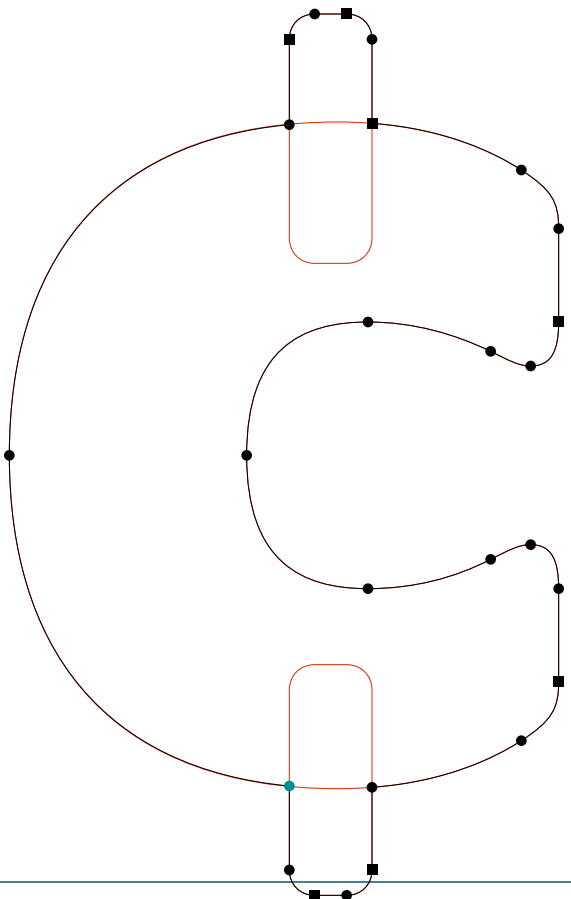
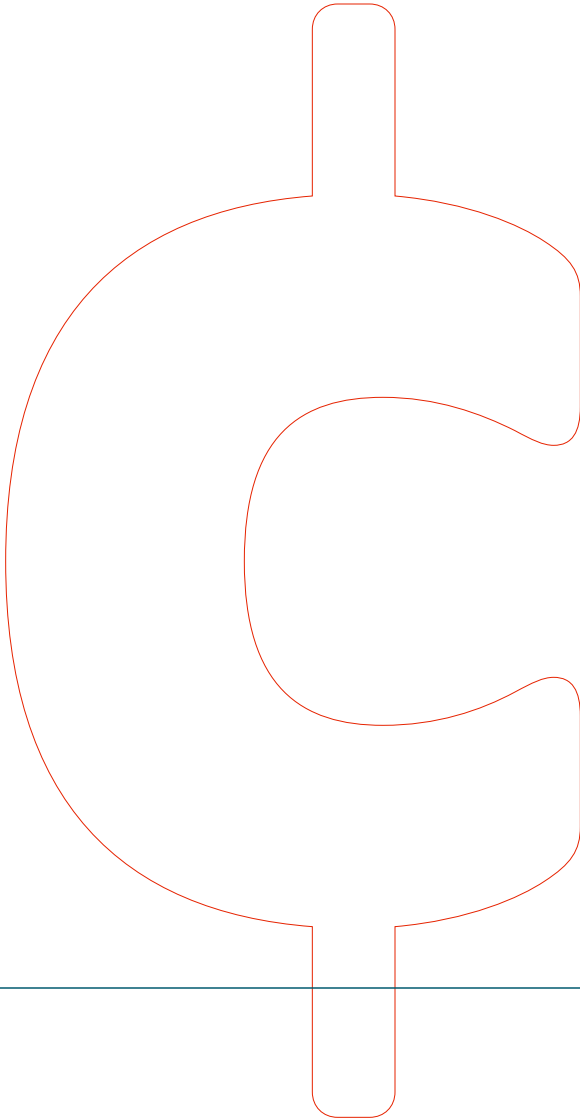

PROGRAM

.....
Program Bold | sterling | RoboFog Sketches | 2013 | Emigre Fonts

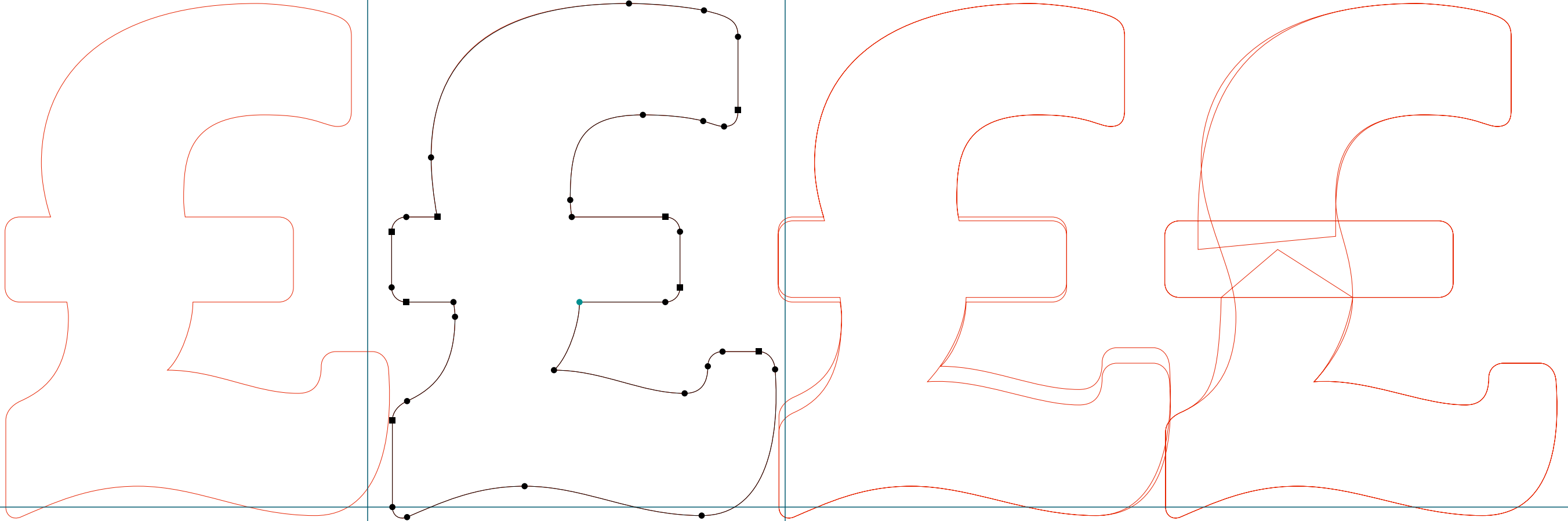

PROGRAM

.....
Program BoldItalic | ampersand | RoboFog Sketches | 2013 | Emigre Fonts

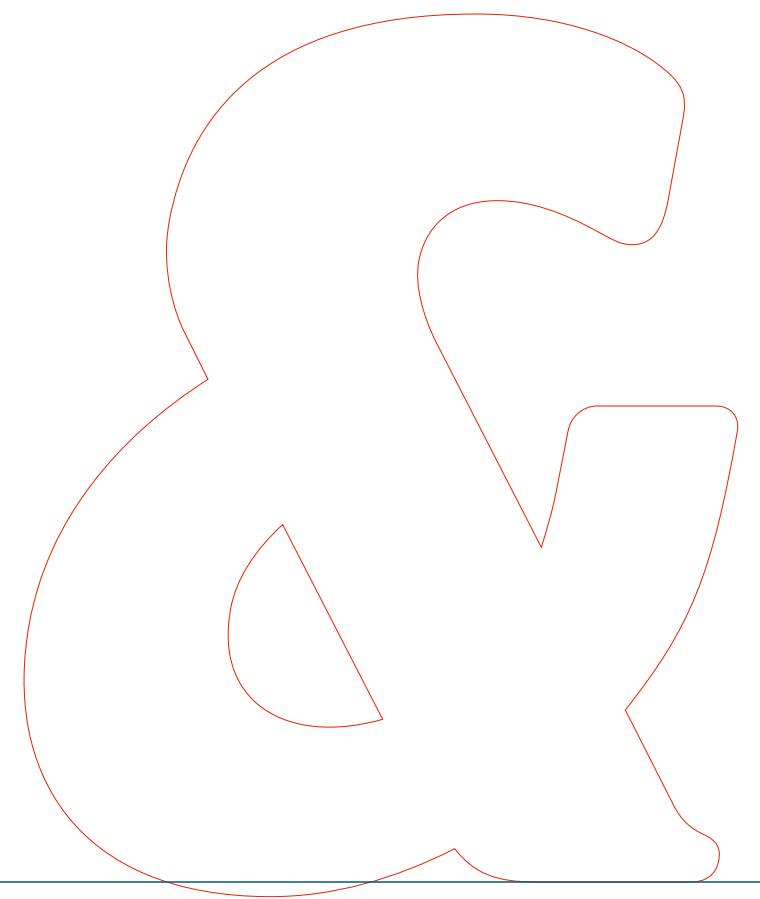
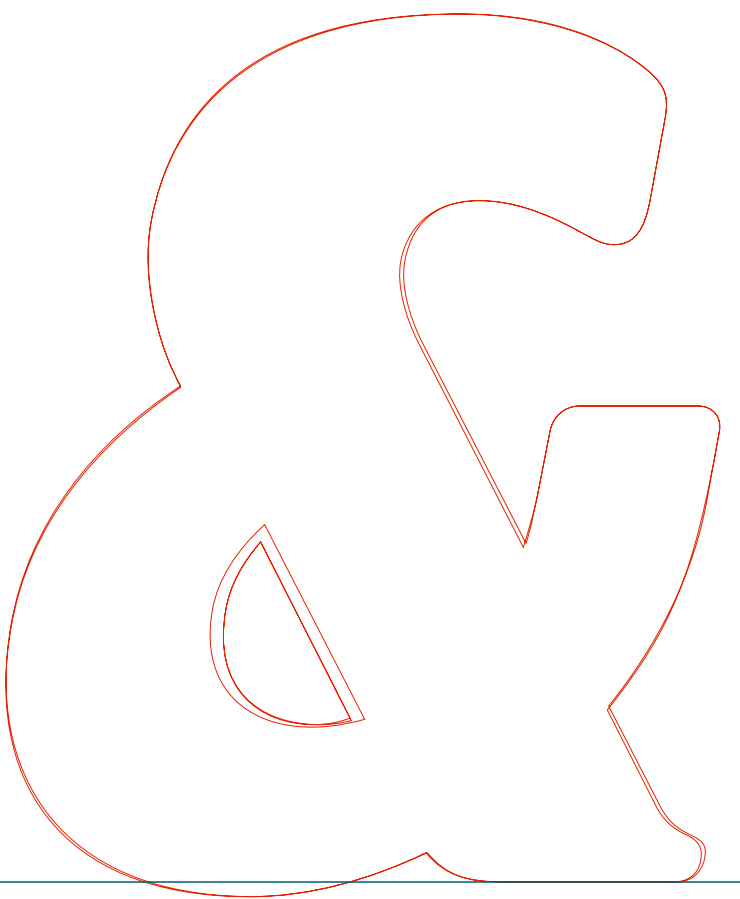
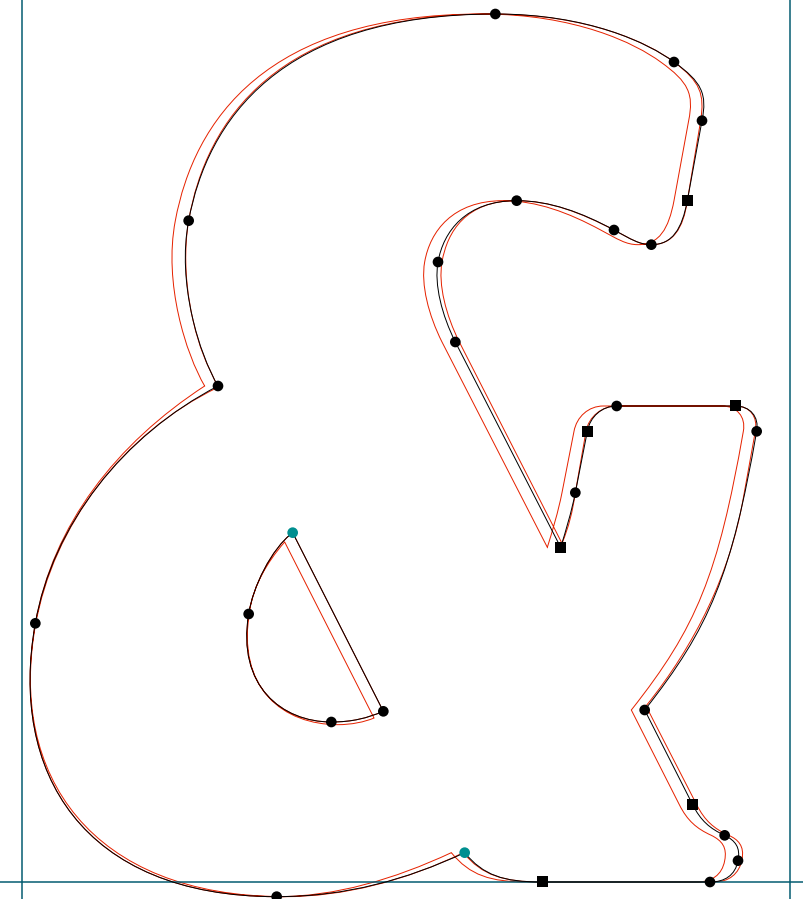
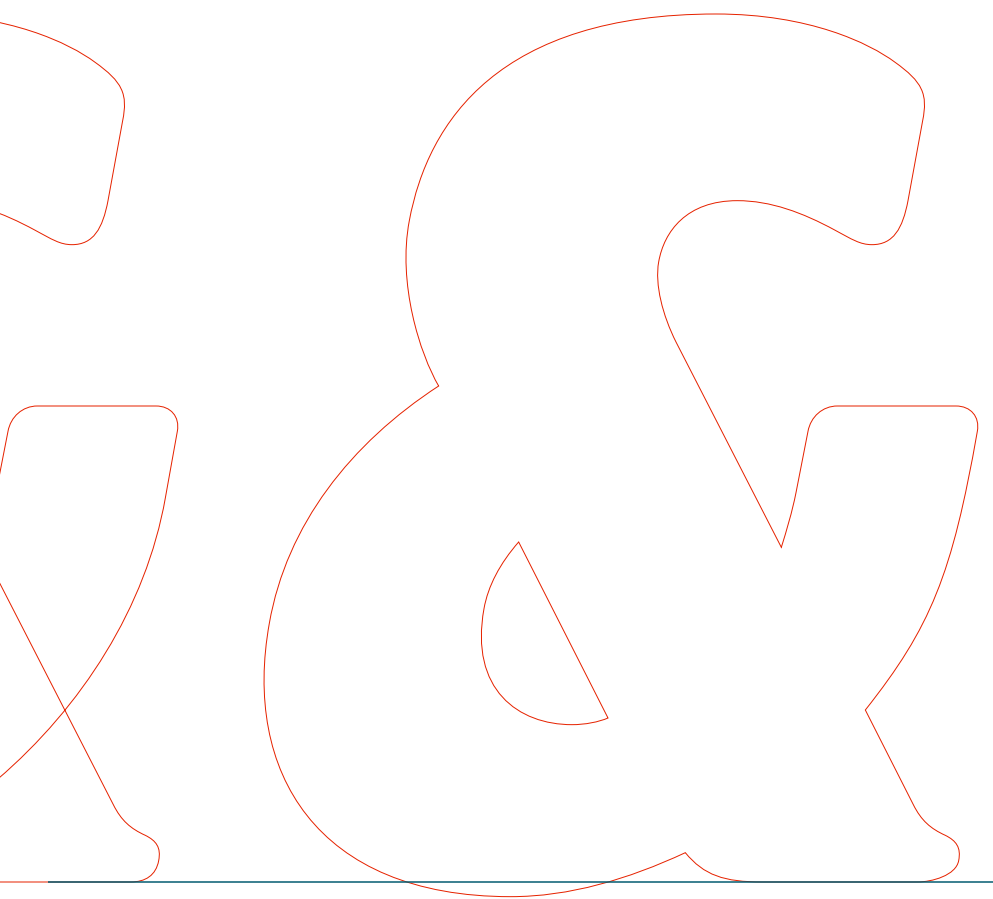

PROGRAM

Program Black | eth | RoboFog Sketches | 2013 | Emigre Fonts

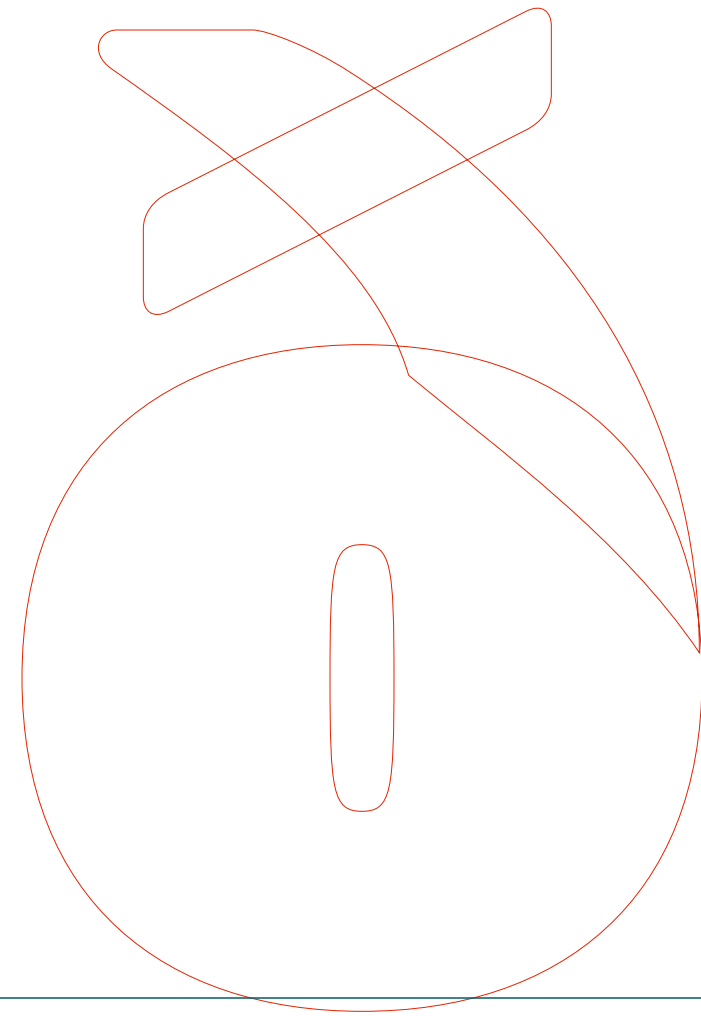
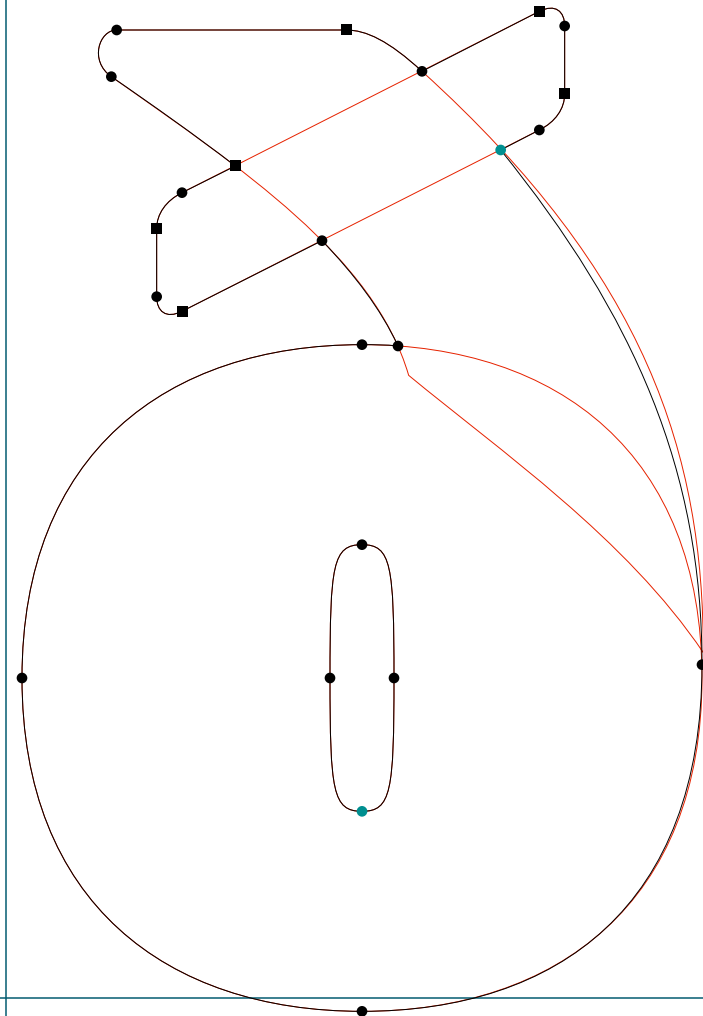
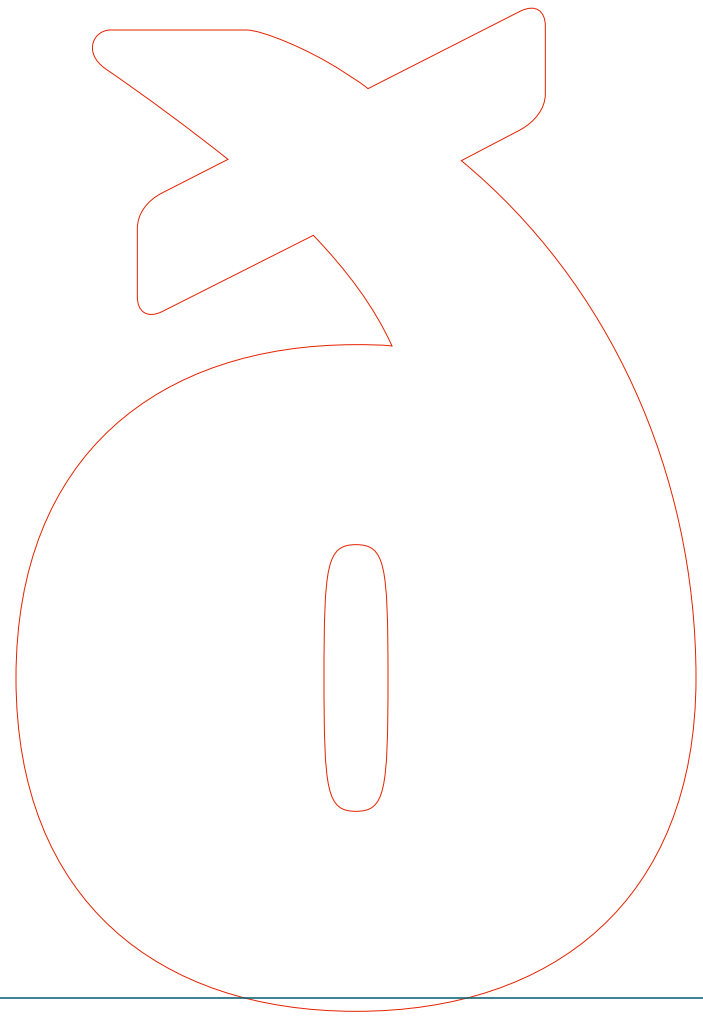

PROGRAM

Program Black | exclam | RoboFog Sketches | 2013 | Emigre Fonts

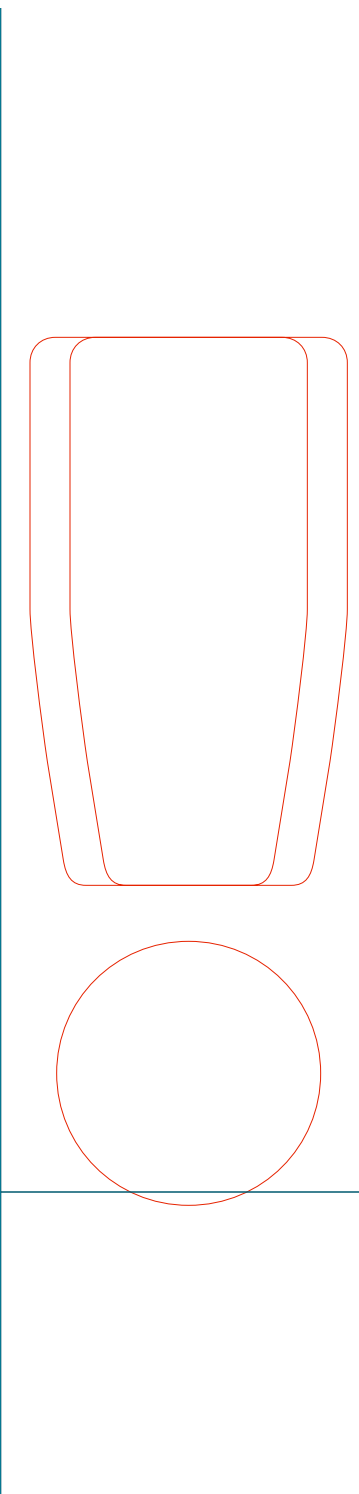
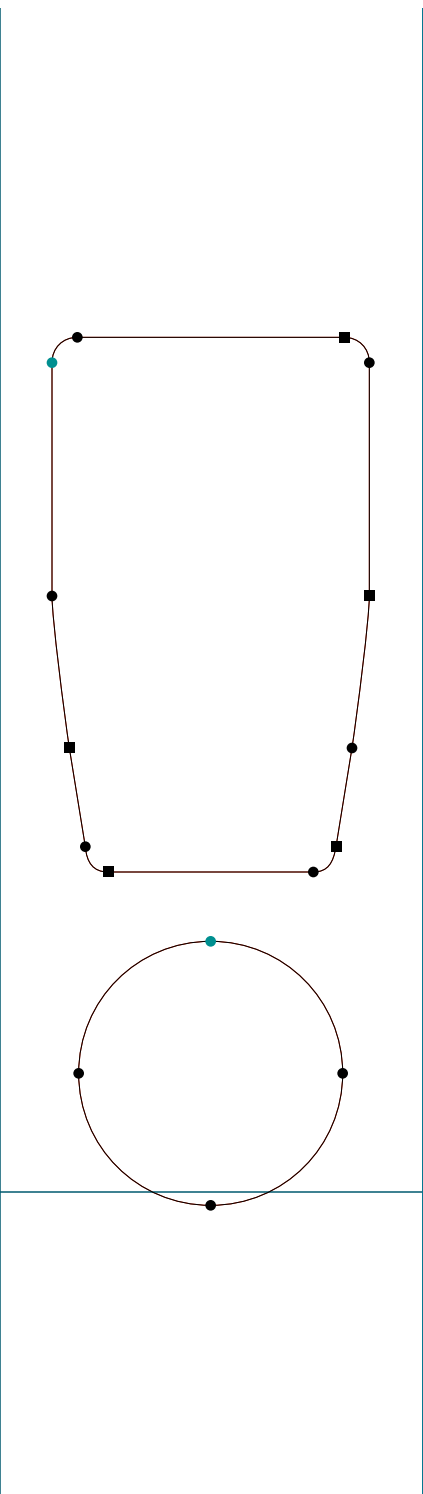

PROGRAM

Program Black | dollar | RoboFog Sketches | 2013 | Emigre Fonts

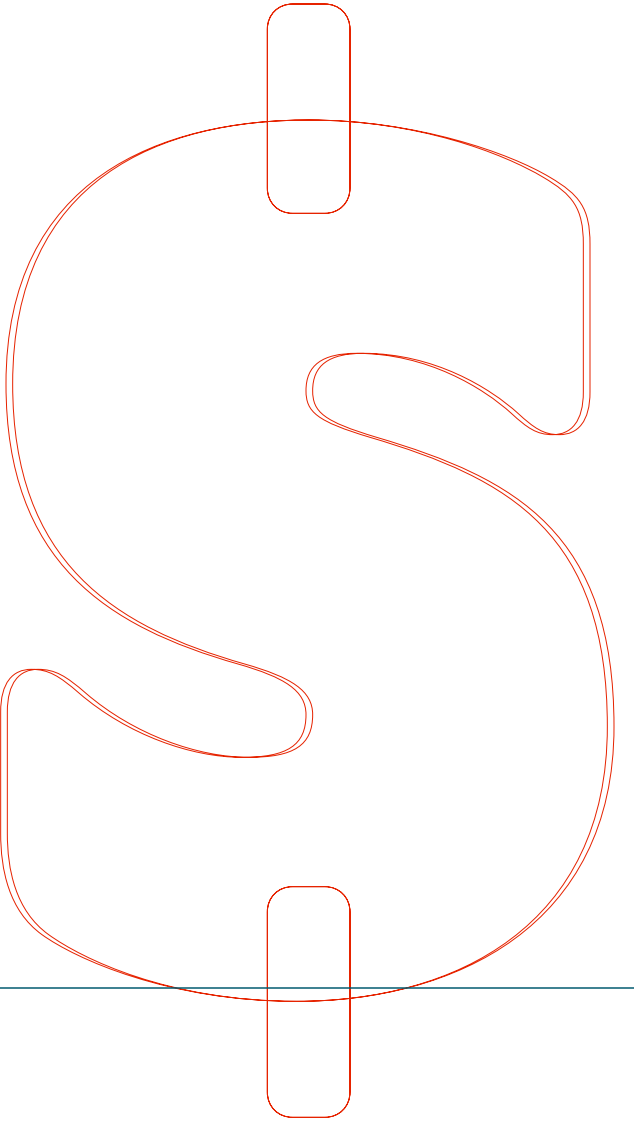
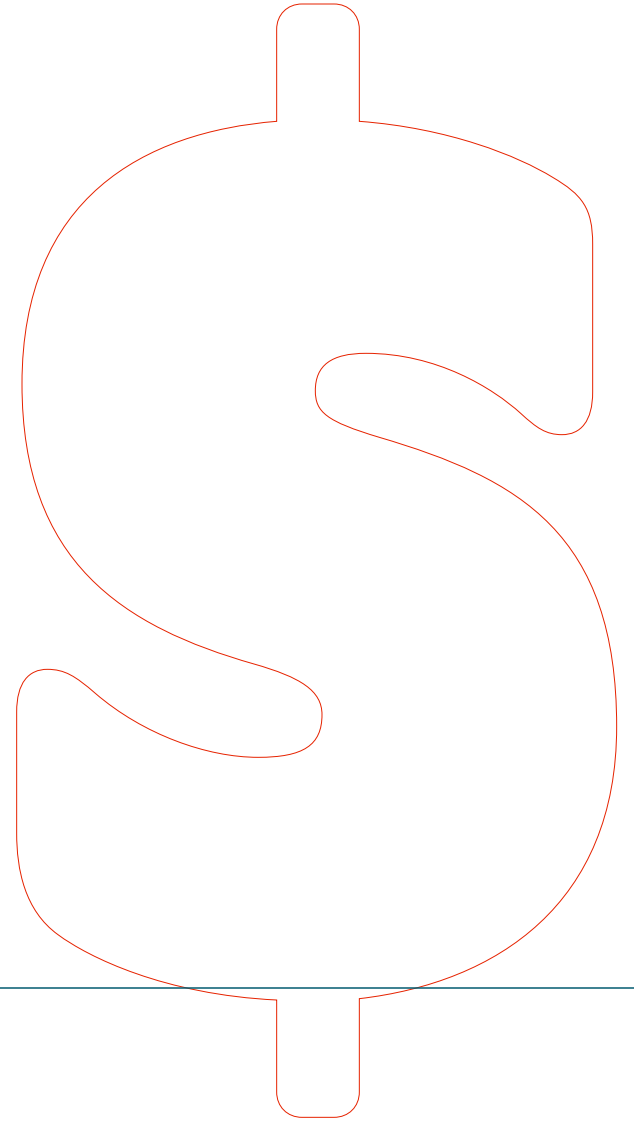
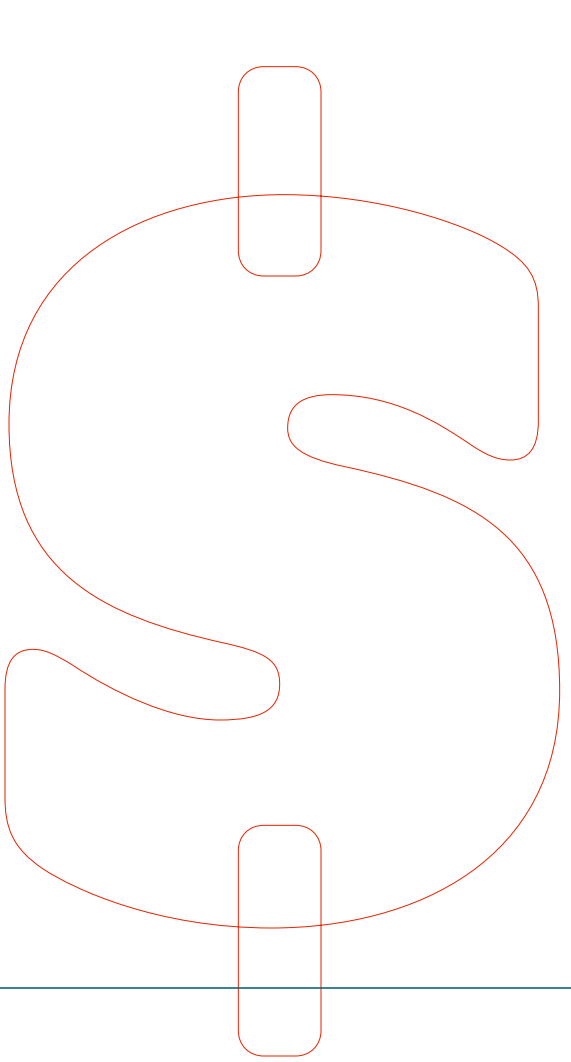
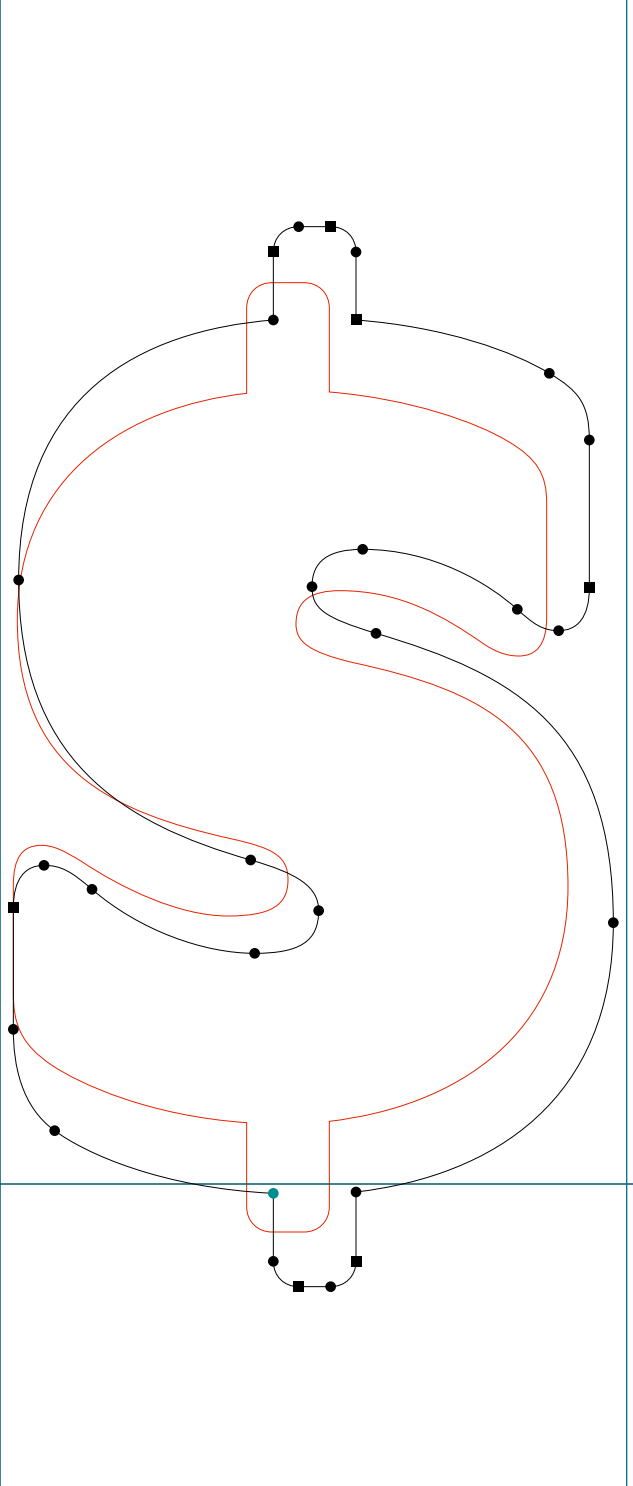

PROGRAM

Program Black | ampersand | RoboFog Sketches | 2013 | Emigre Fonts

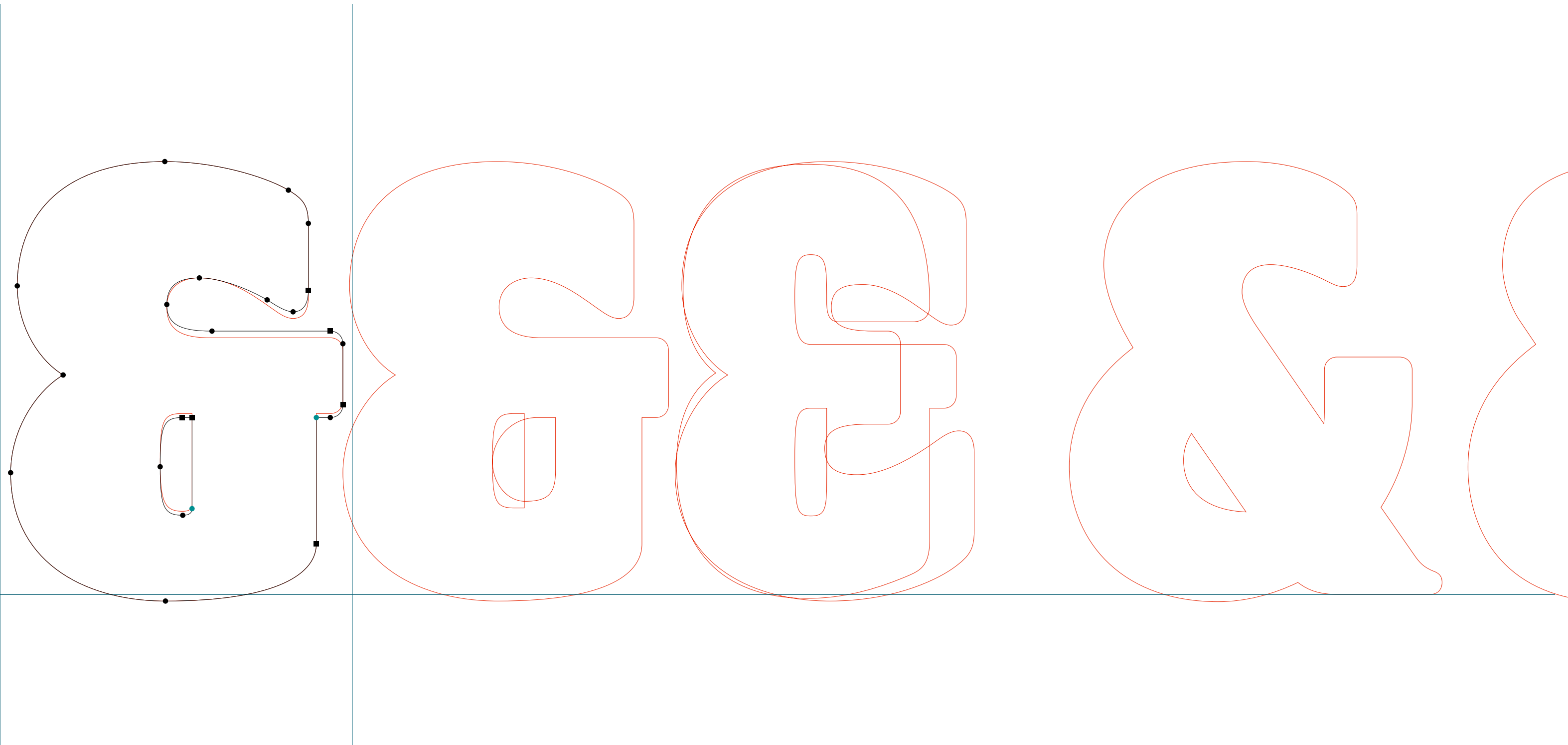

PROGRAM

.....
Program Black | comma | RoboFog Sketches | 2013 | Emigre Fonts

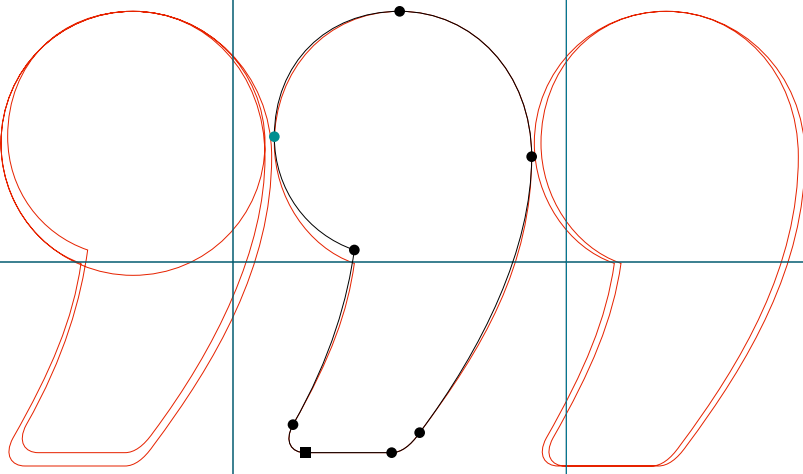

PROGRAM

.....
Program Black | zero | RoboFog Sketches | 2013 | Emigre Fonts

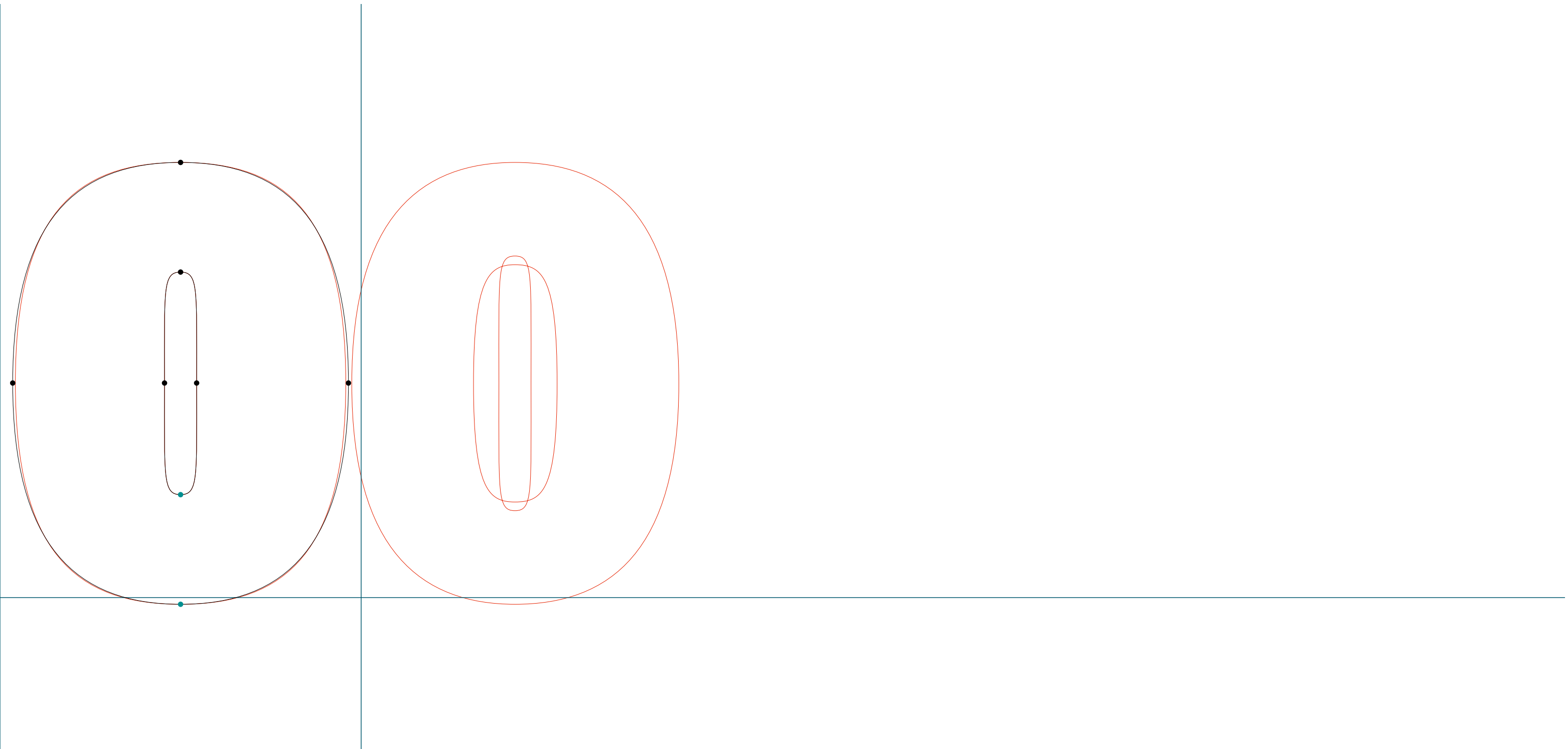

PROGRAM

.....
Program Black | three | RoboFog Sketches | 2013 | Emigre Fonts

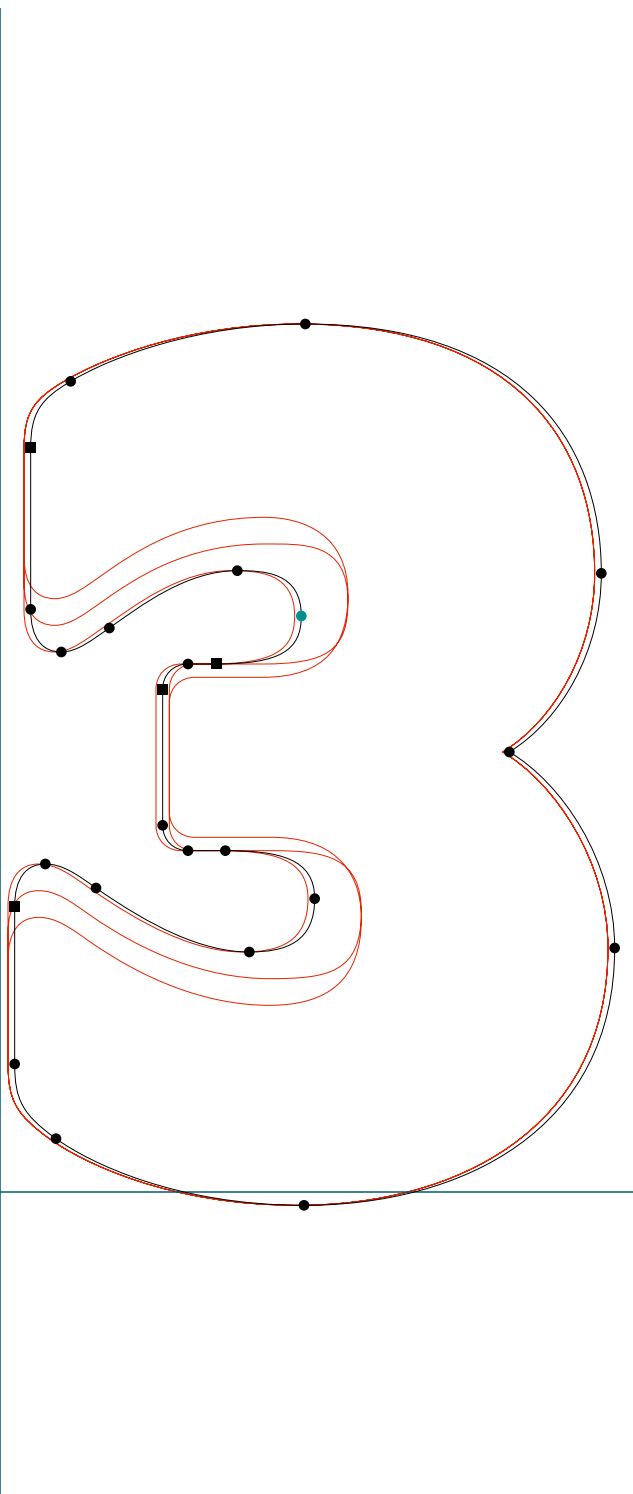

PROGRAM

Program Black | five | RoboFog Sketches | 2013 | Emigre Fonts

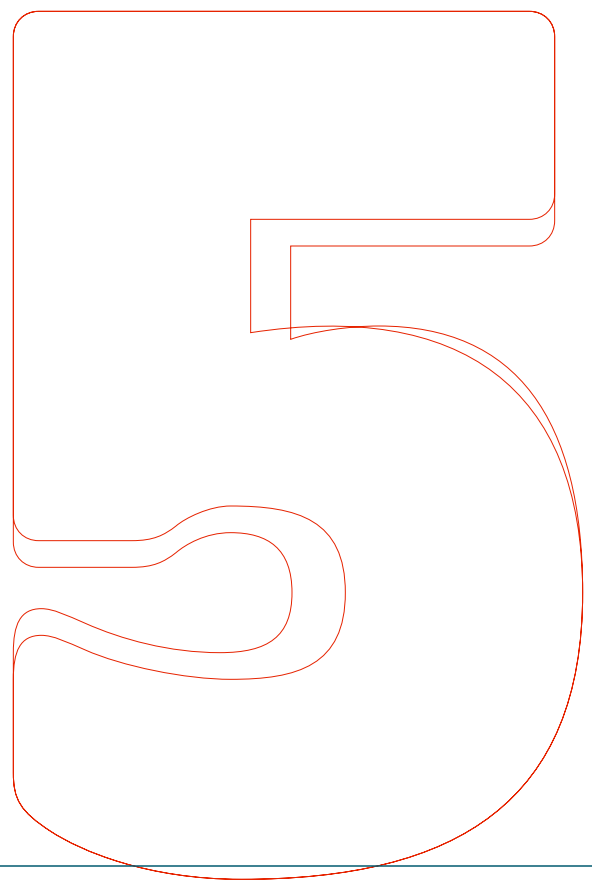
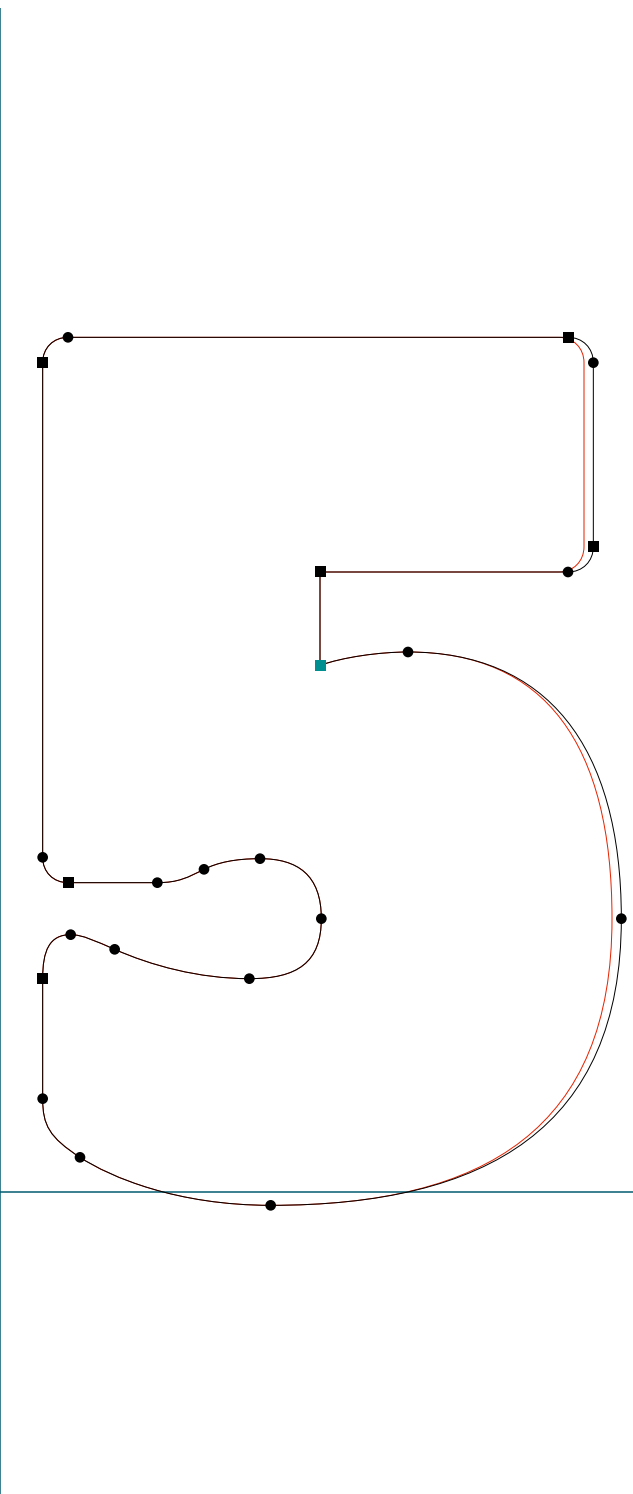

PROGRAM

.....
Program Black | six | RoboFog Sketches | 2013 | Emigre Fonts

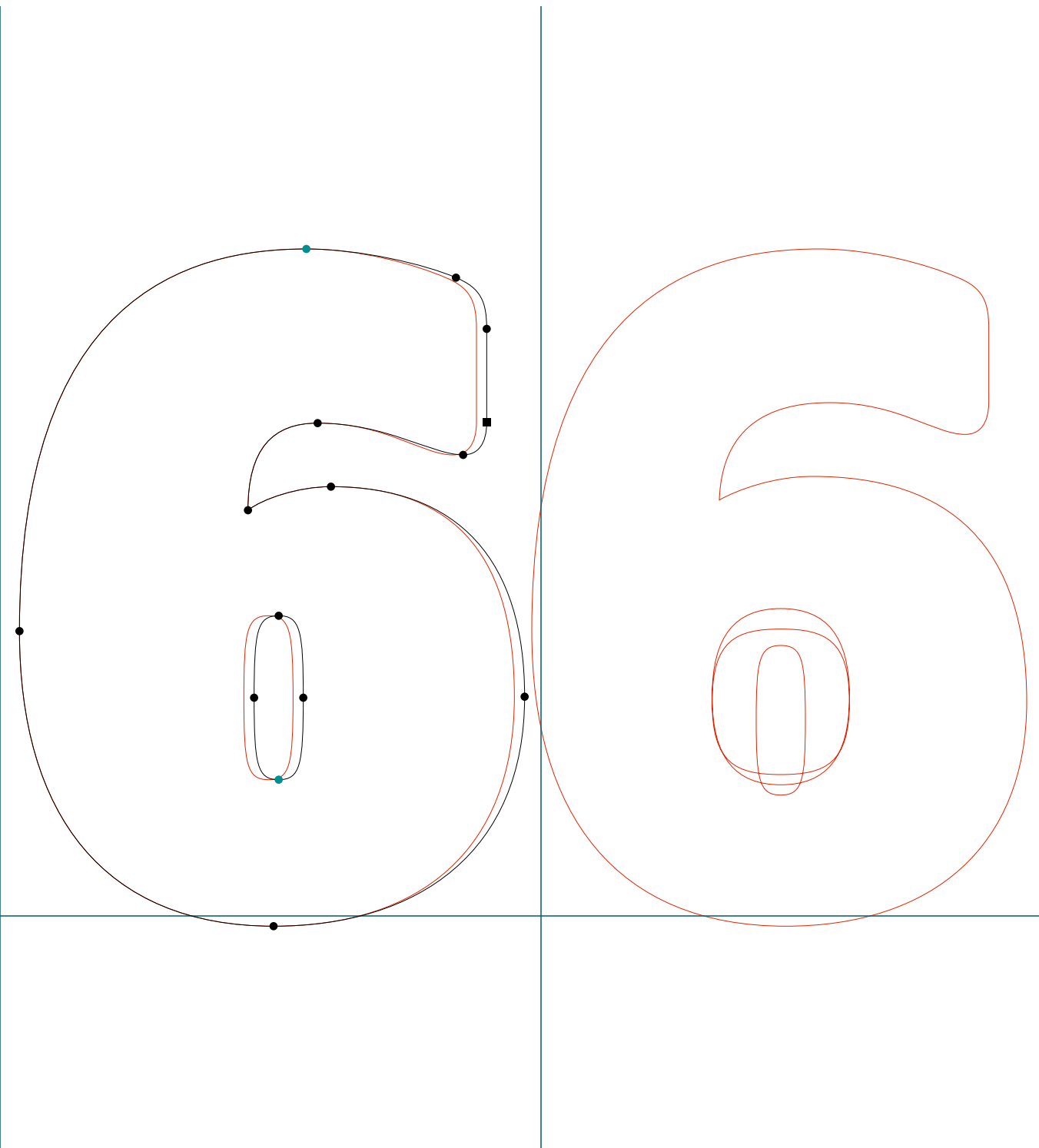

PROGRAM

.....
Program Black | nine | RoboFog Sketches | 2013 | Emigre Fonts

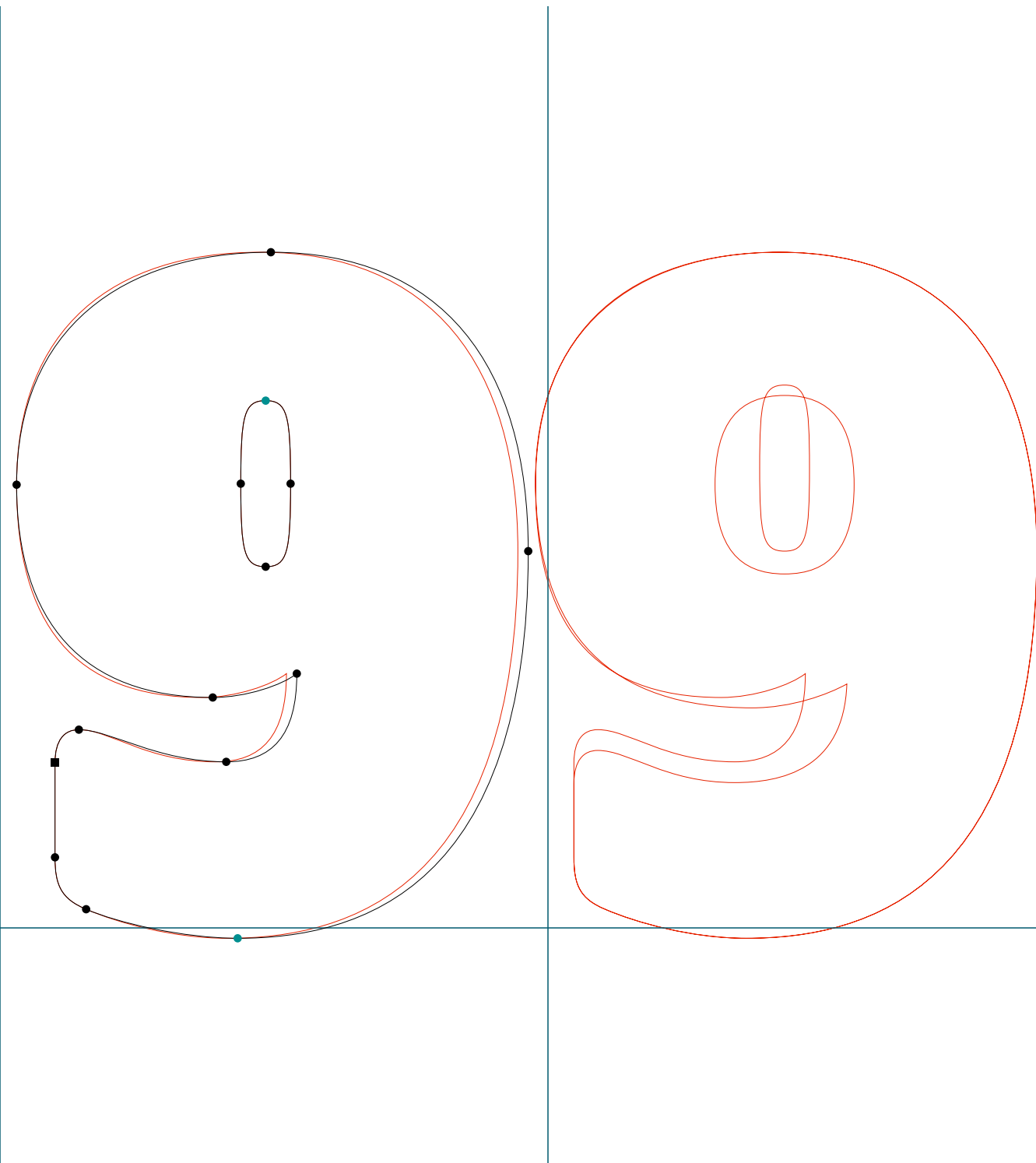

PROGRAM

.....
Program Black | less | RoboFog Sketches | 2013 | Emigre Fonts

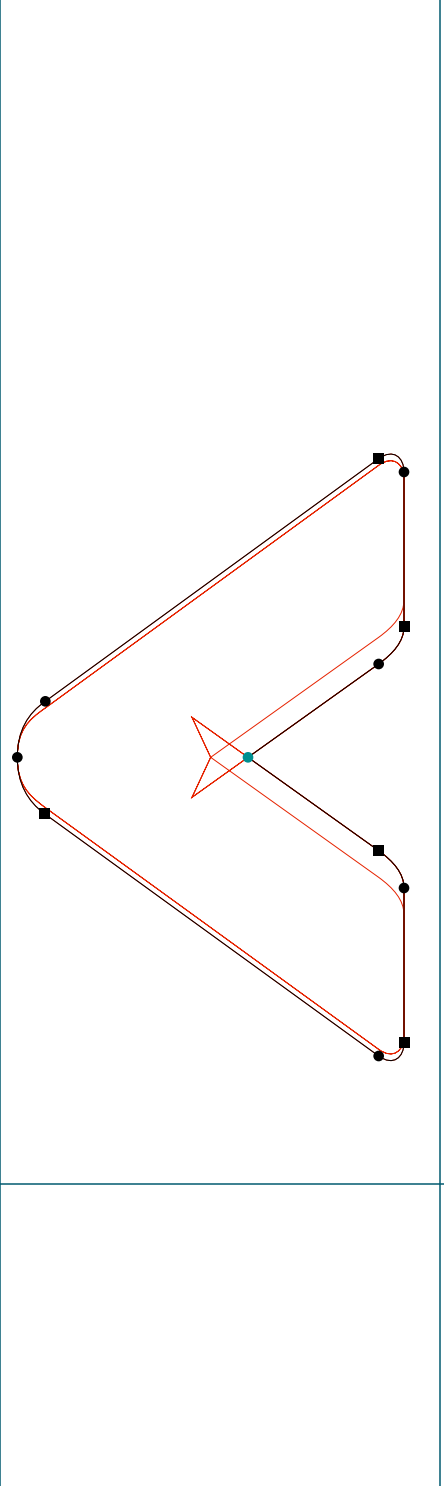

PROGRAM

.....
Program Black | at | RoboFog Sketches | 2013 | Emigre Fonts

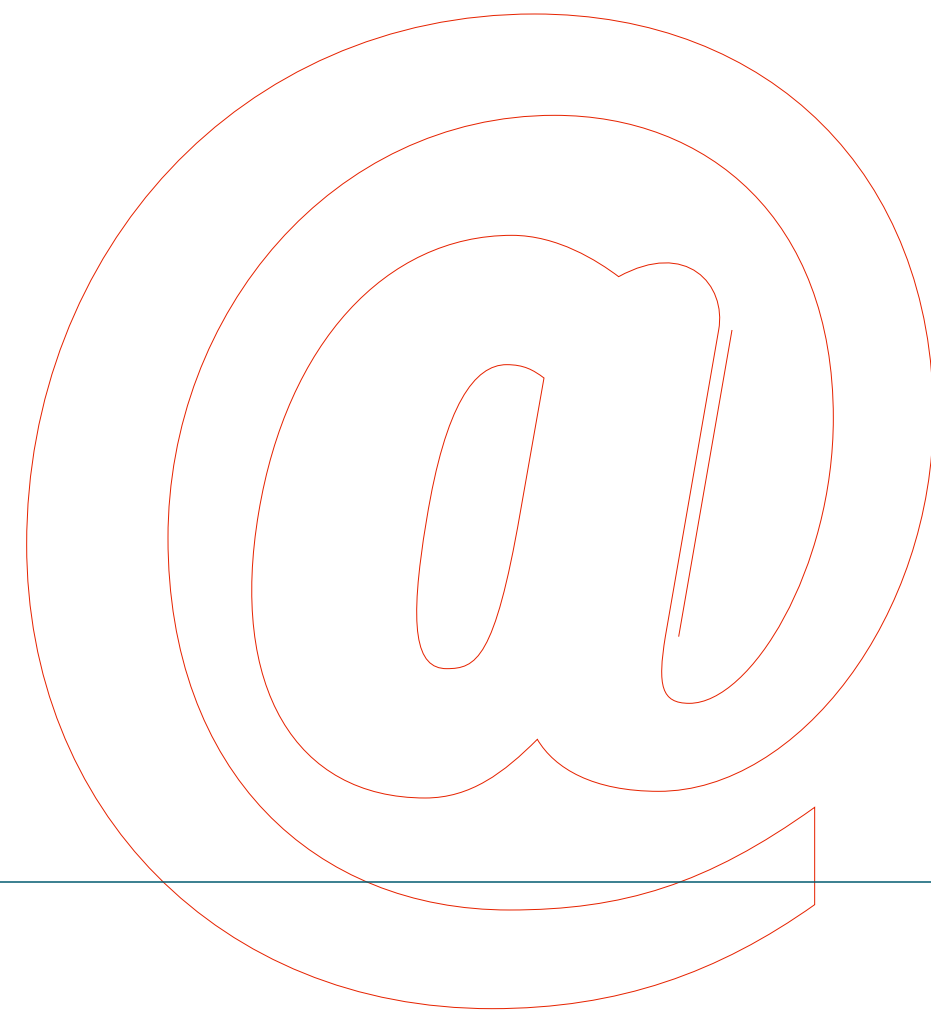
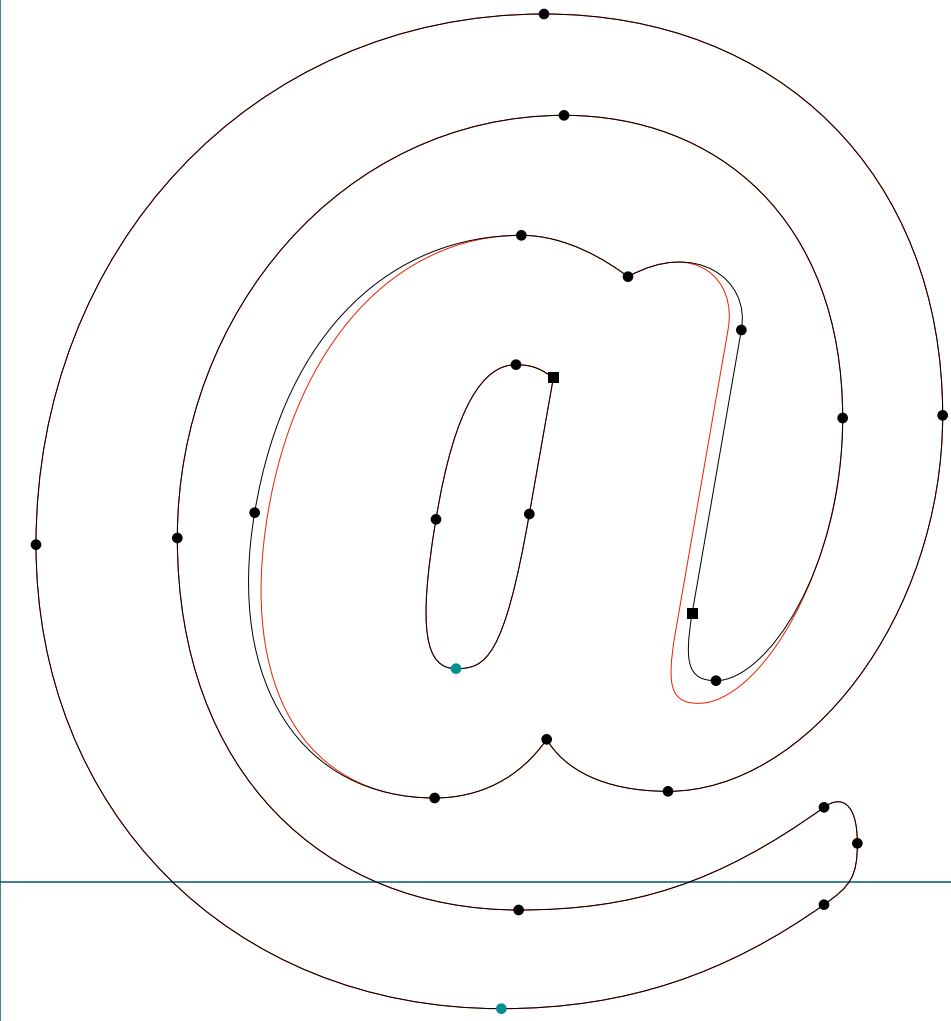

PROGRAM

.....
Program Black | G | RoboFog Sketches | 2013 | Emigre Fonts

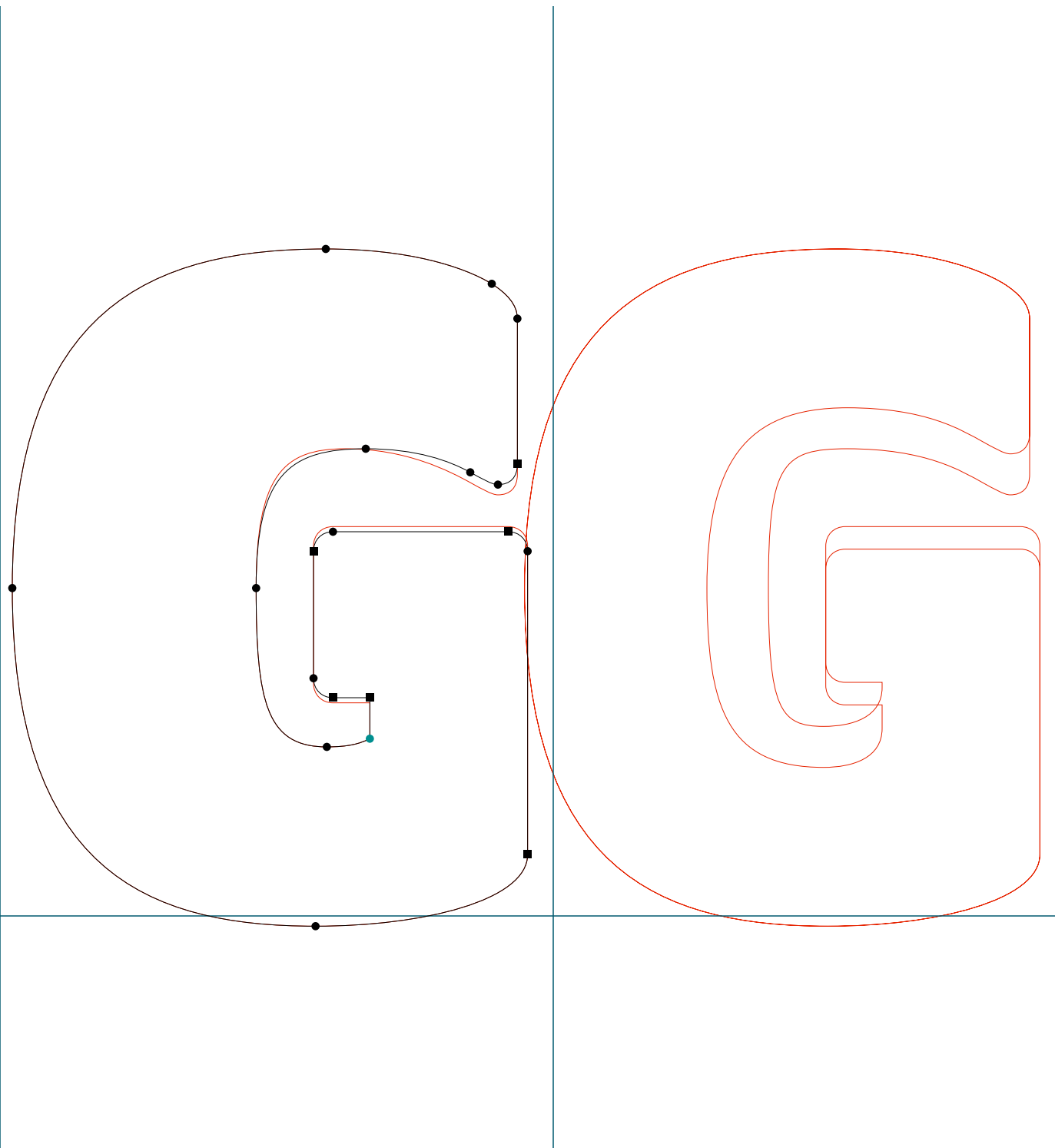

PROGRAM

.....
Program Black | Q | RoboFog Sketches | 2013 | Emigre Fonts

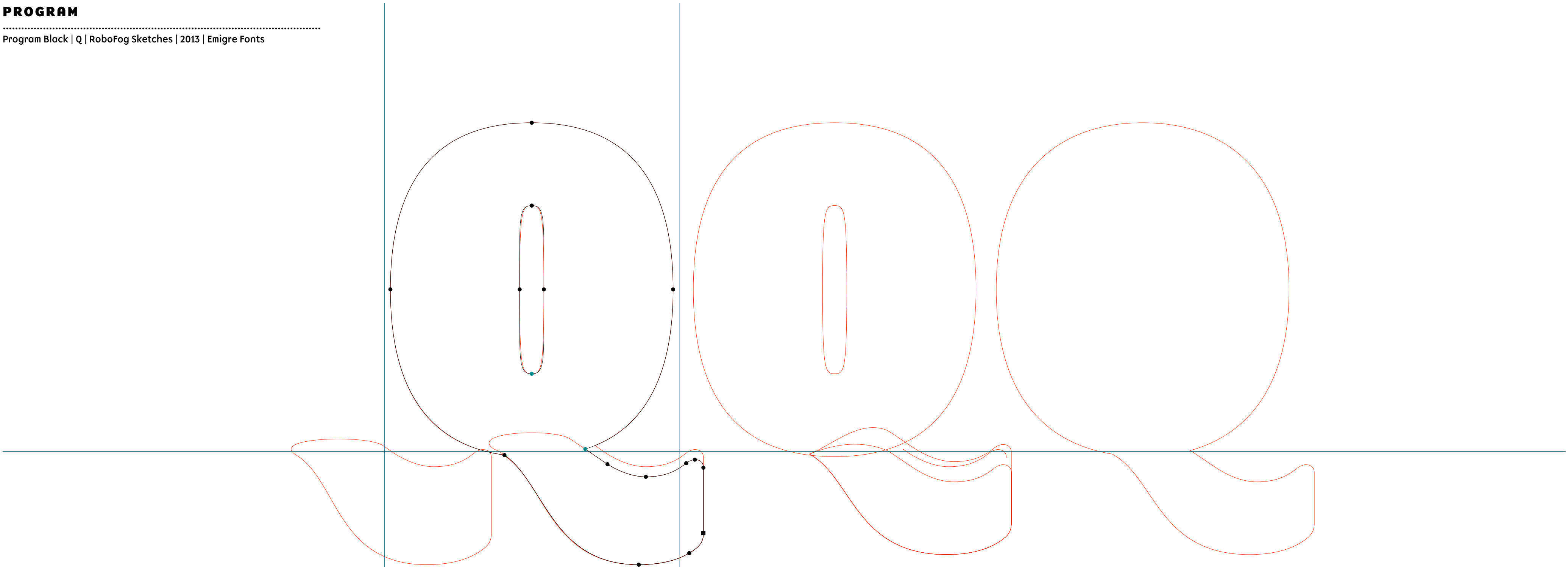

PROGRAM

.....
Program Black | S | RoboFog Sketches | 2013 | Emigre Fonts

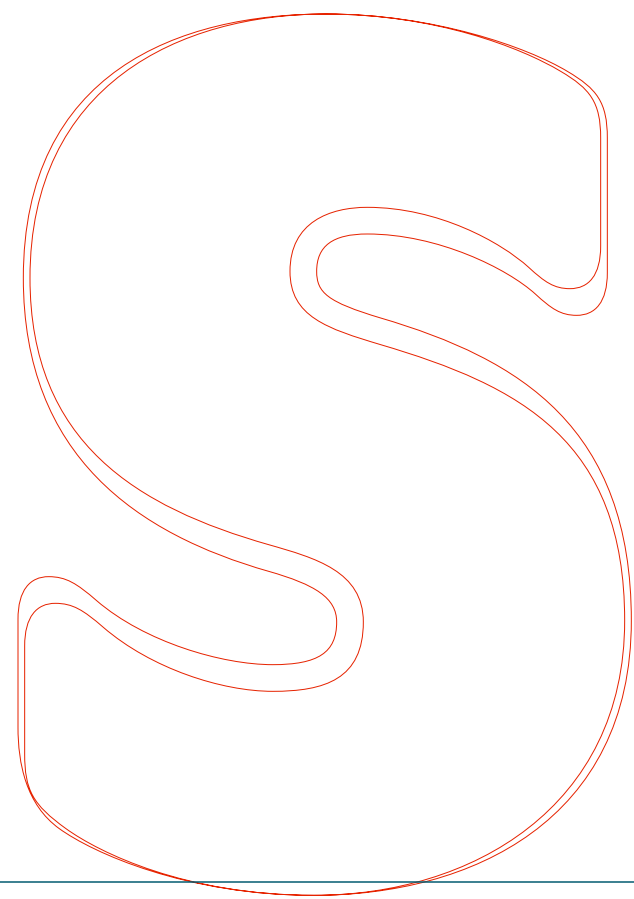
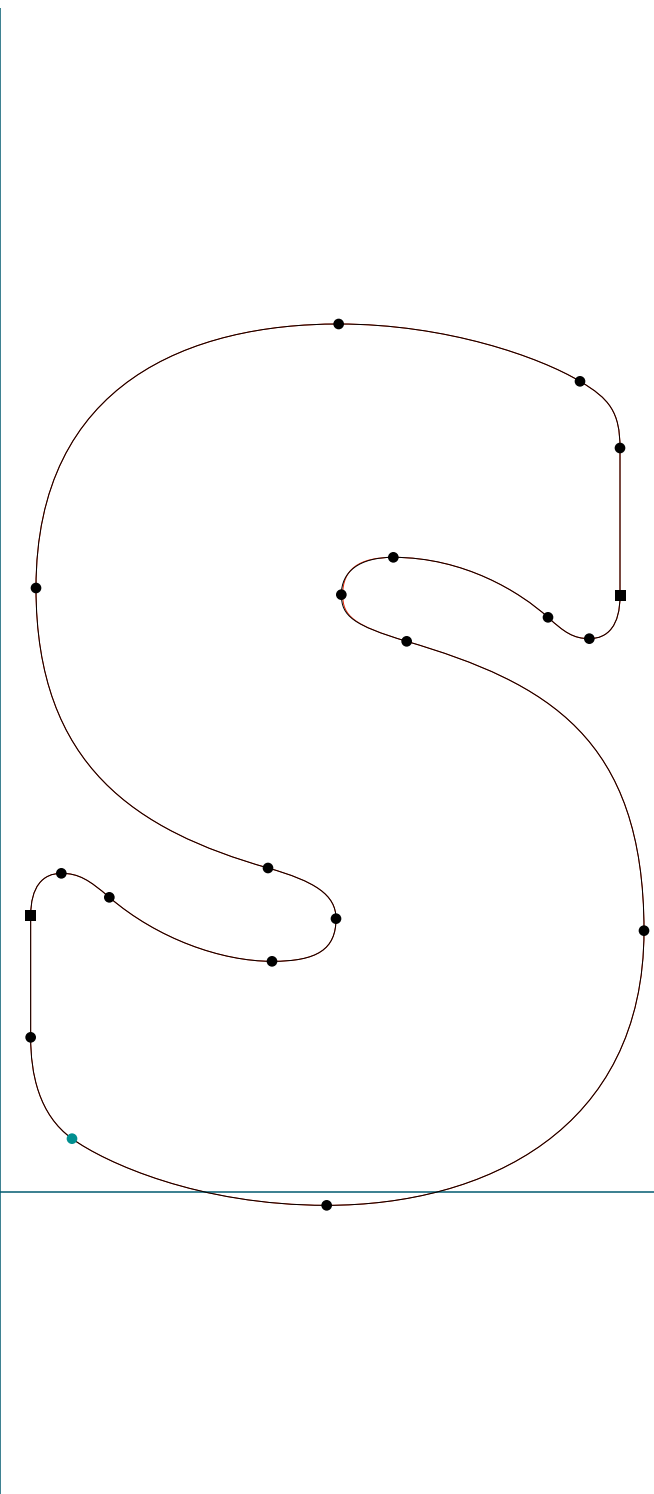

PROGRAM

.....
Program Black | W | RoboFog Sketches | 2013 | Emigre Fonts

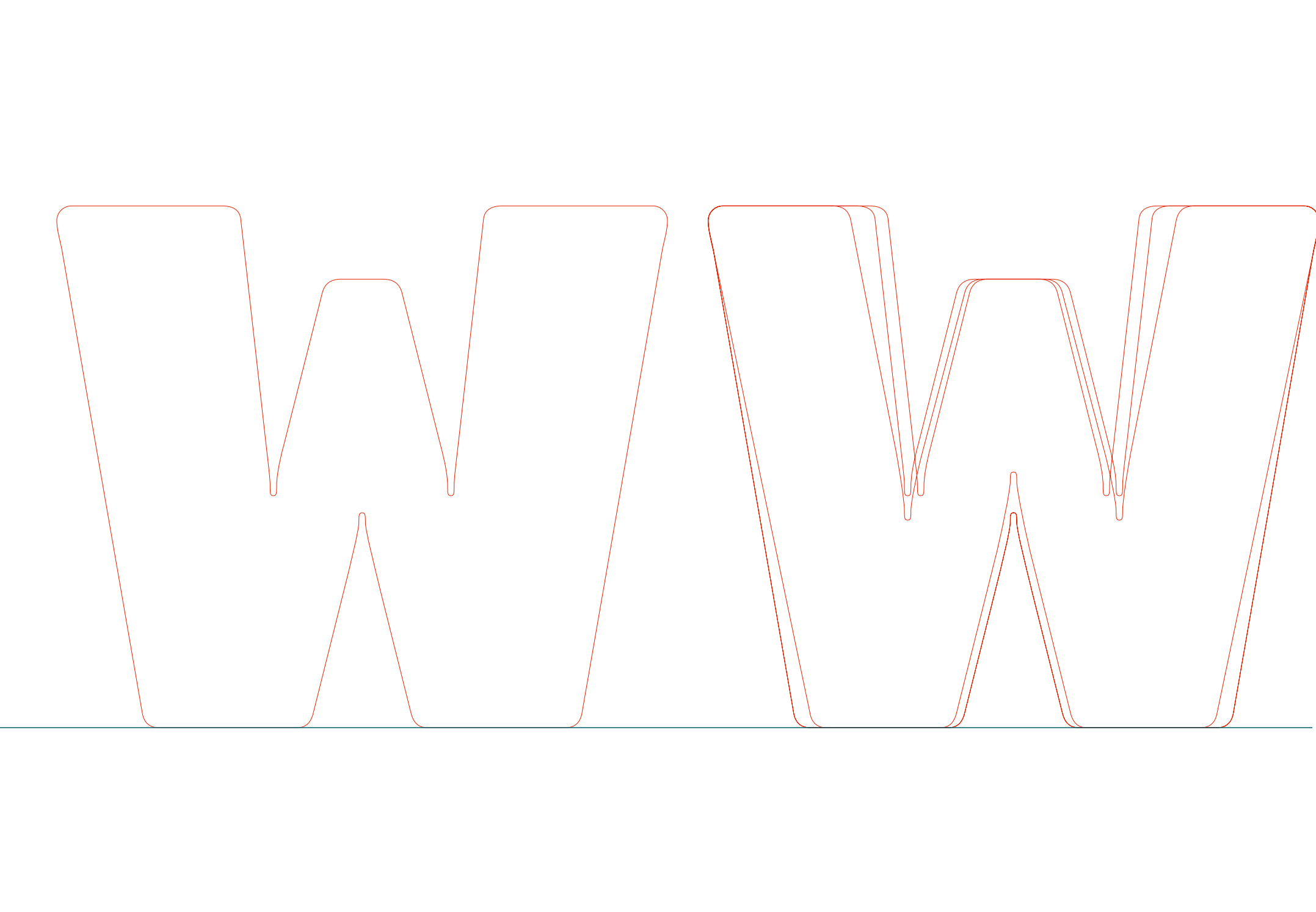
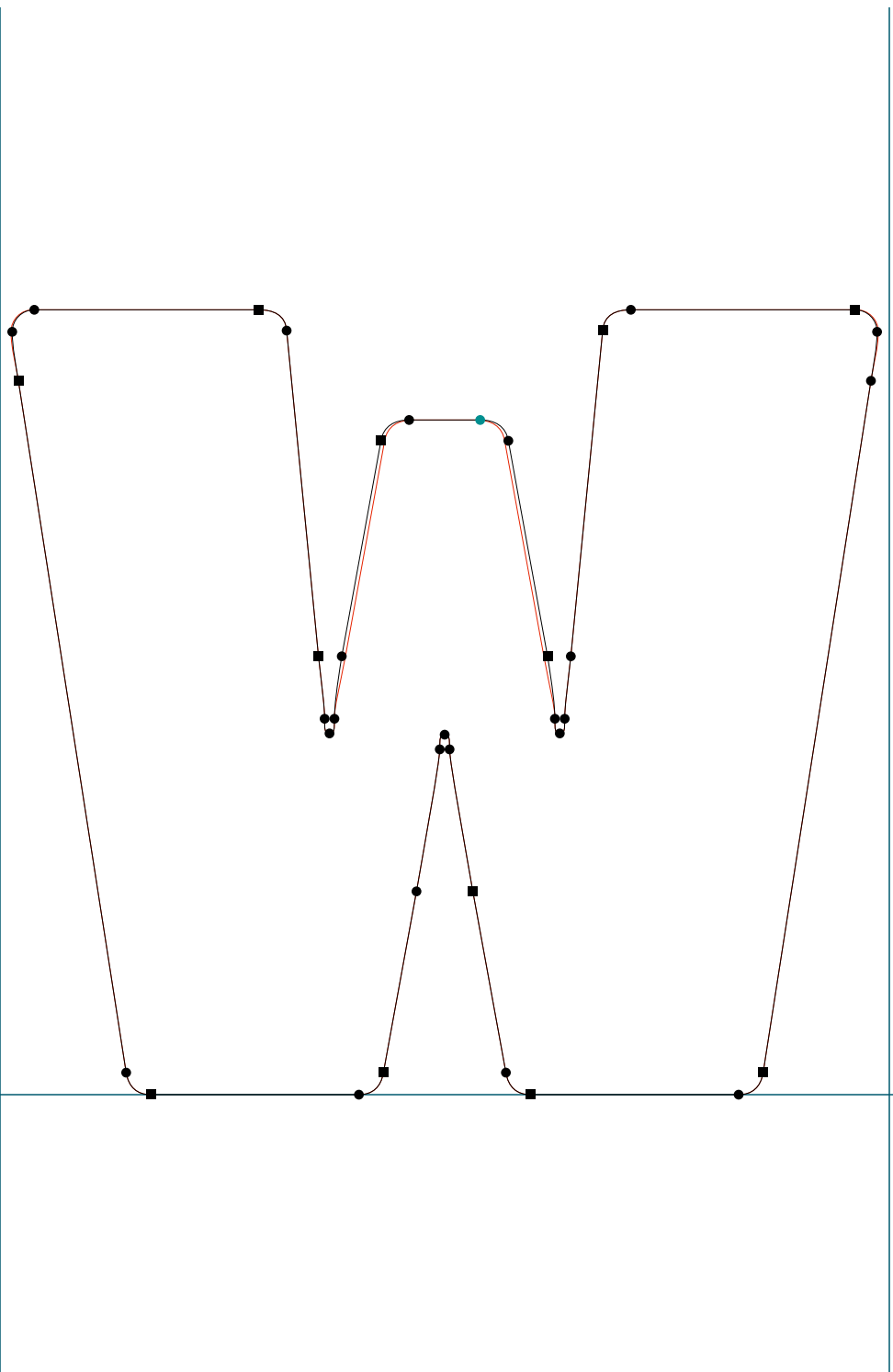

PROGRAM

.....
Program Black | g | RoboFog Sketches | 2013 | Emigre Fonts

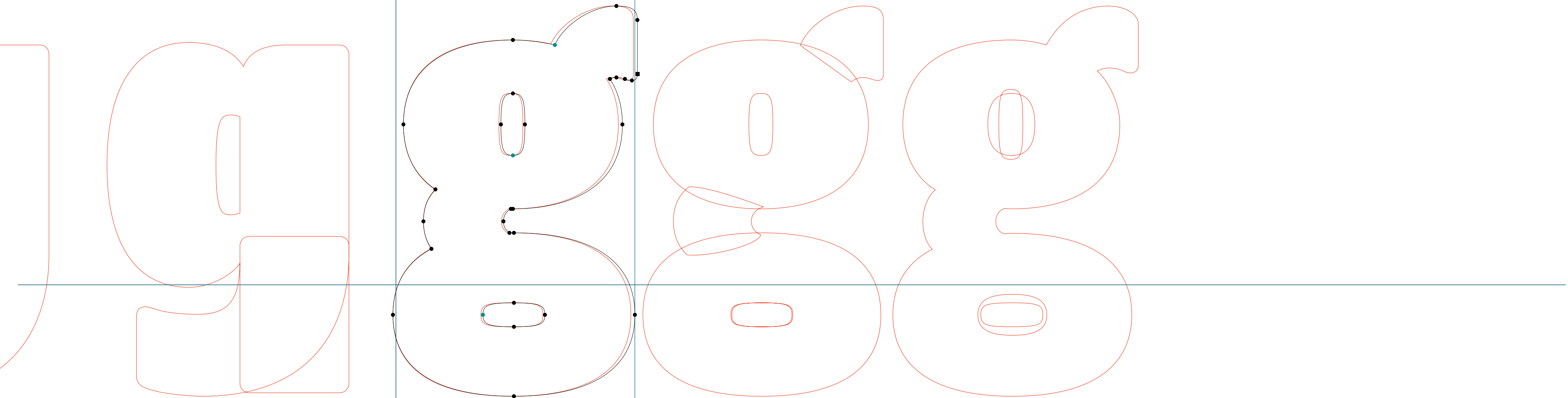

PROGRAM

.....
Program Black | h | RoboFog Sketches | 2013 | Emigre Fonts

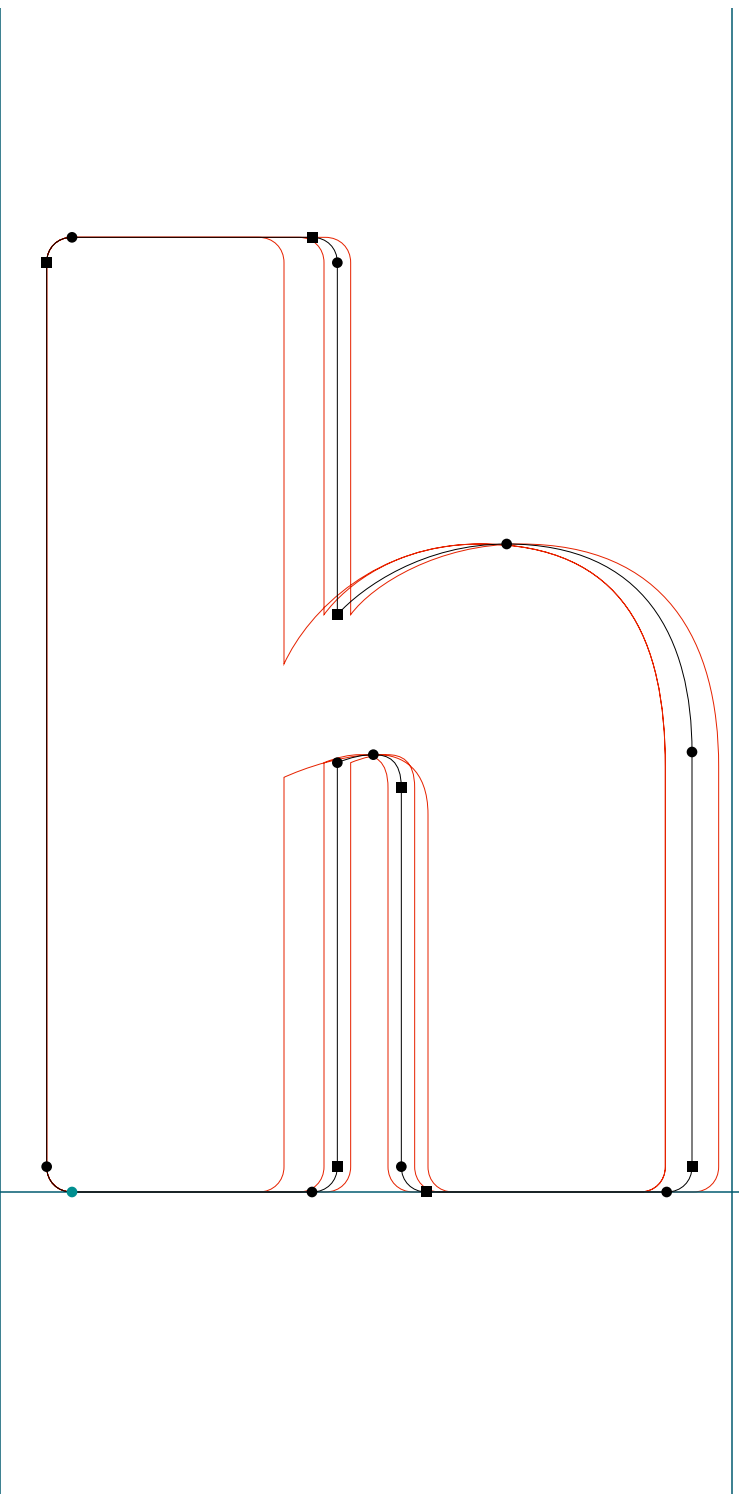

PROGRAM

.....
Program Black | o | RoboFog Sketches | 2013 | Emigre Fonts

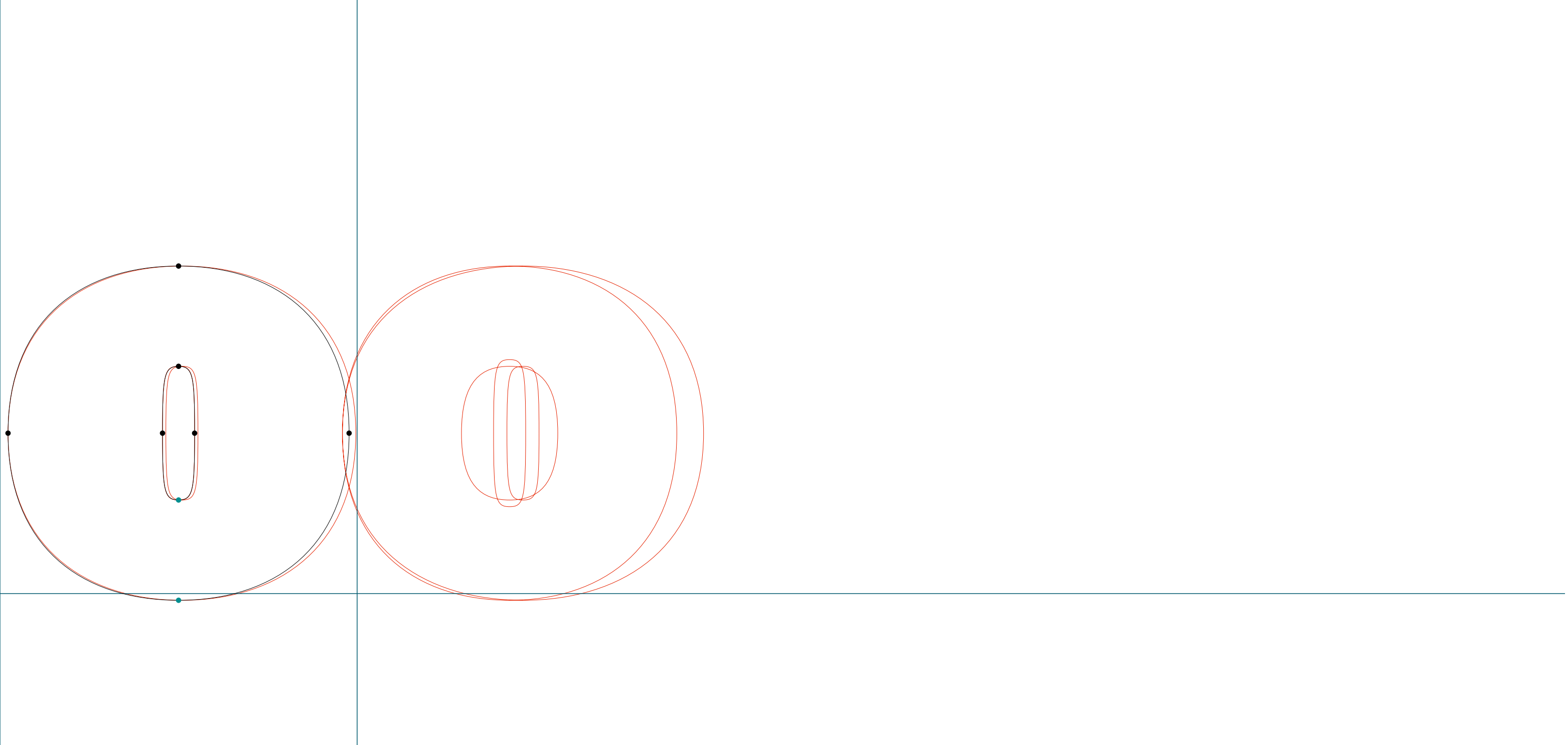

PROGRAM

.....
Program Black | cent | RoboFog Sketches | 2013 | Emigre Fonts

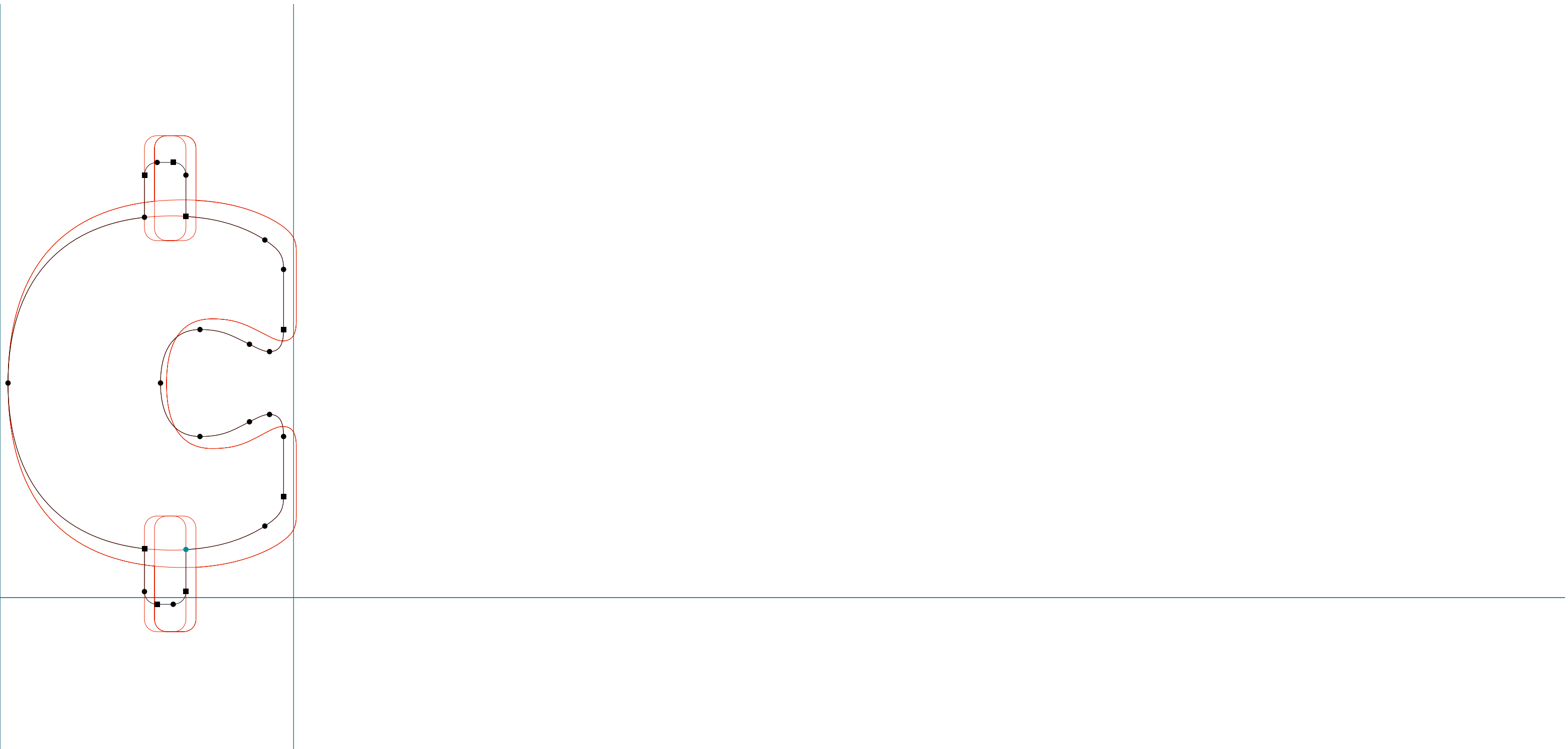

PROGRAM

.....
Program Black | sterling | RoboFog Sketches | 2013 | Emigre Fonts

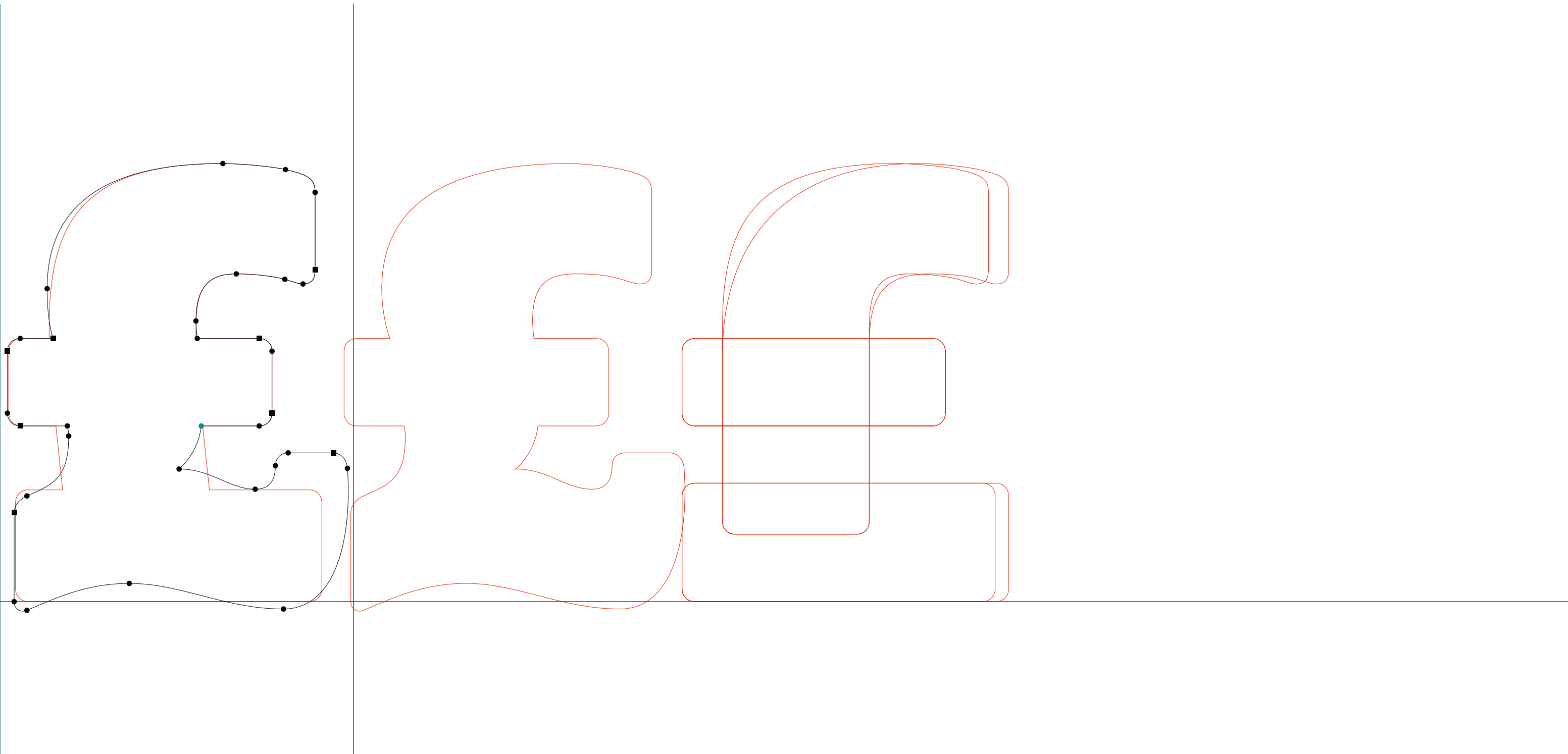

PROGRAM

.....
Program Black | section | RoboFog Sketches | 2013 | Emigre Fonts

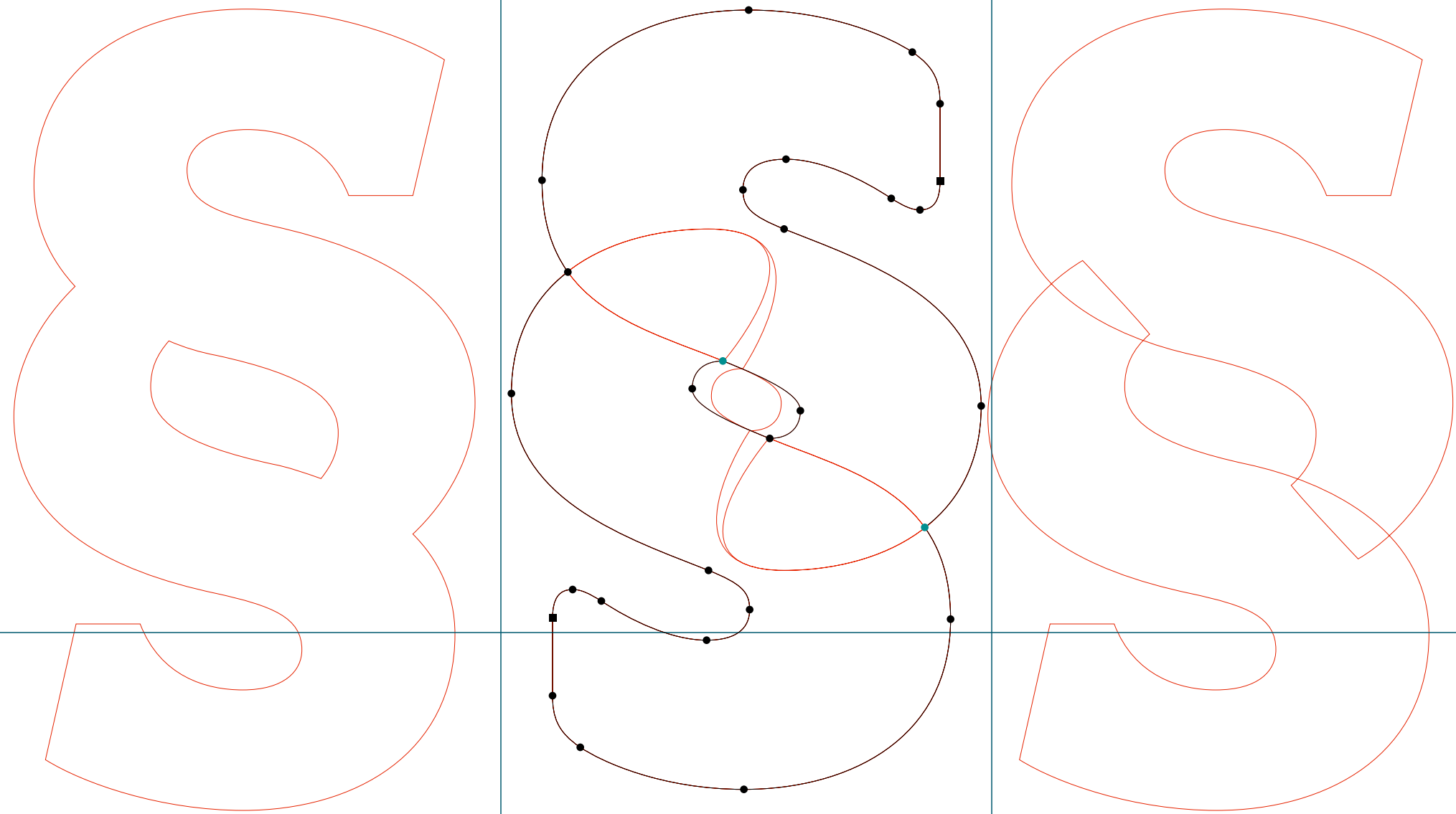

PROGRAM

Program Black | germandbls | RoboFog Sketches | 2013 | Emigre Fonts

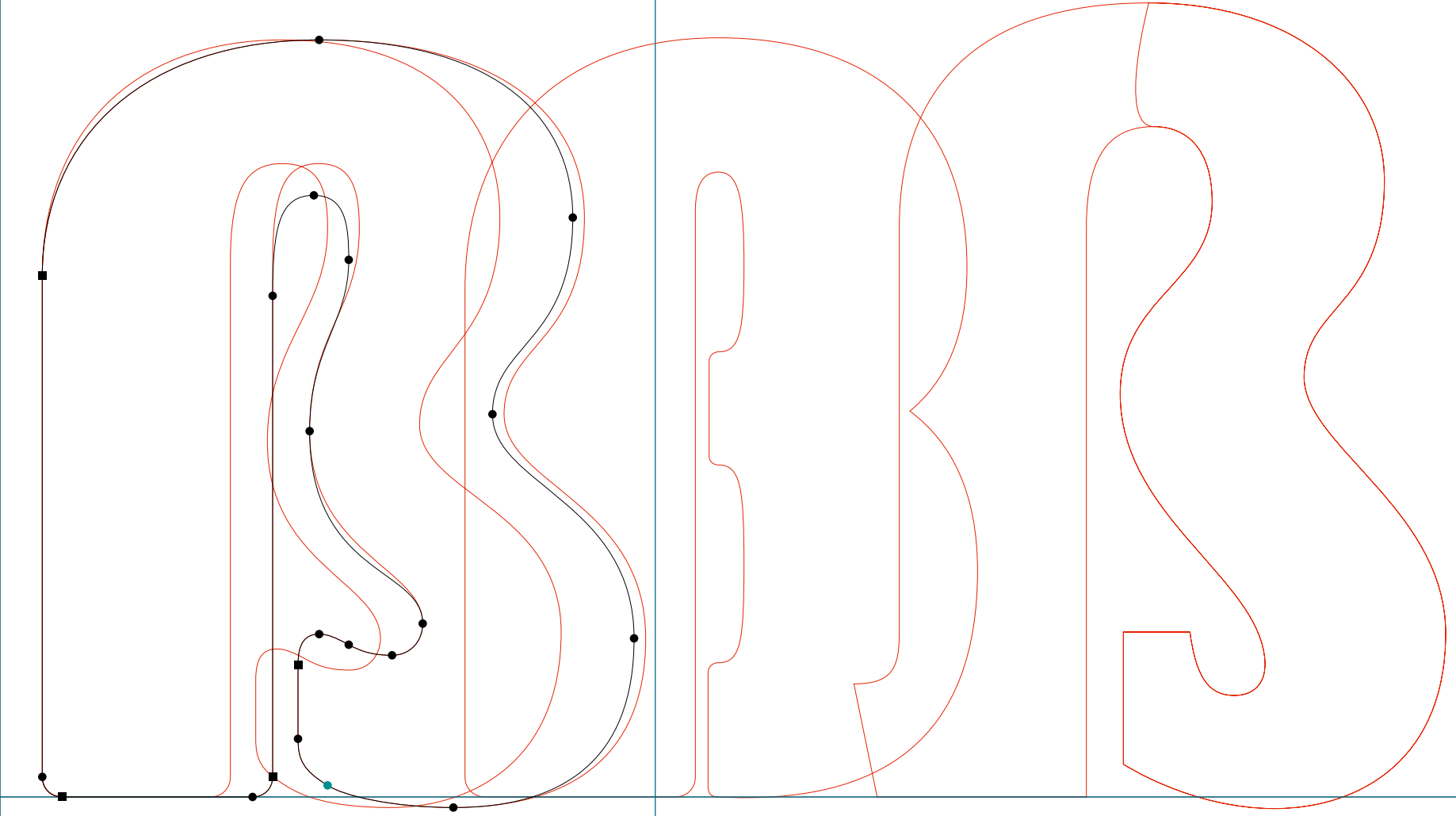

PROGRAM

.....
Program Black | ae | RoboFog Sketches | 2013 | Emigre Fonts

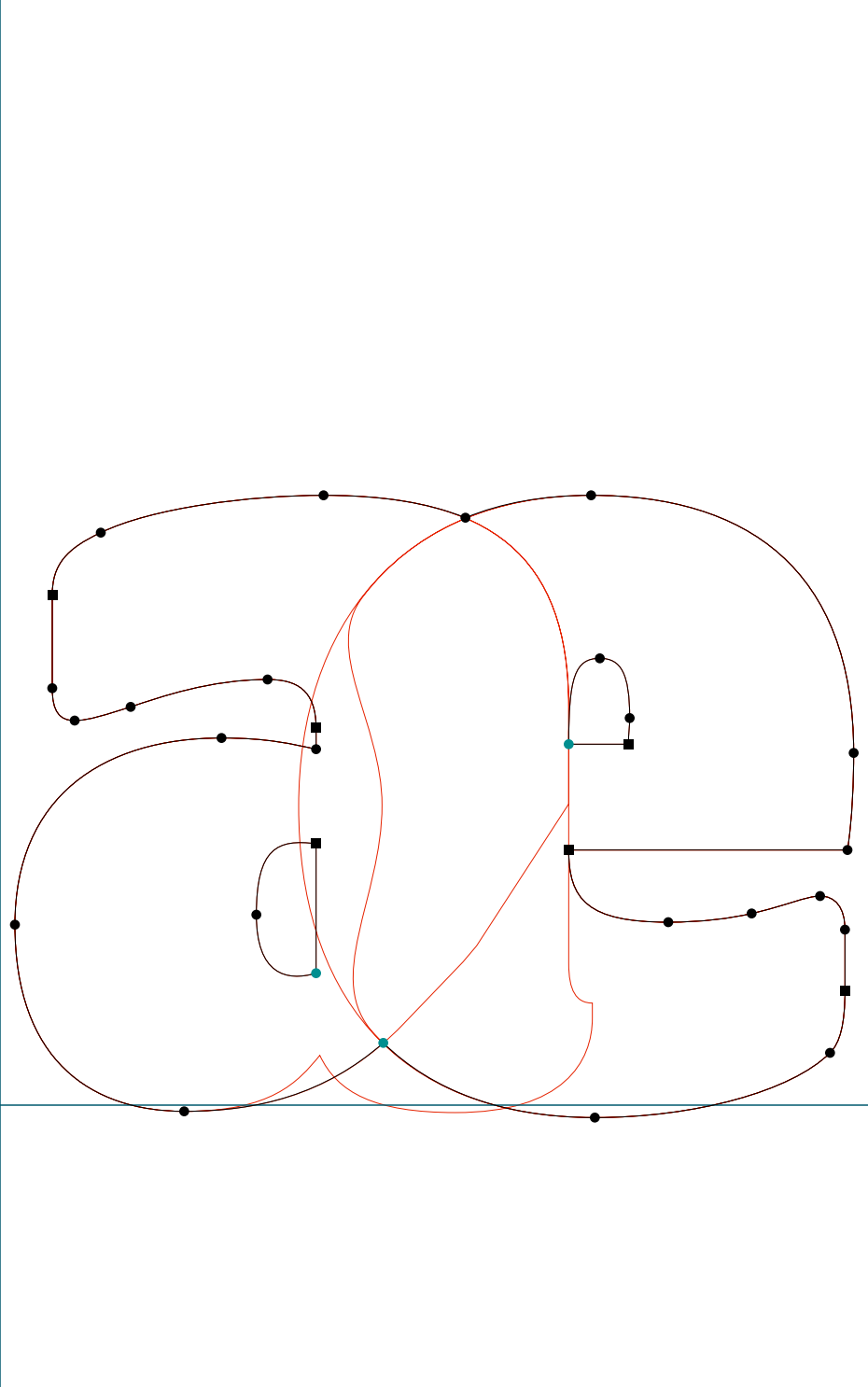

PROGRAM

.....
Program Black | approxequal | RoboFog Sketches | 2013 | Emigre Fonts

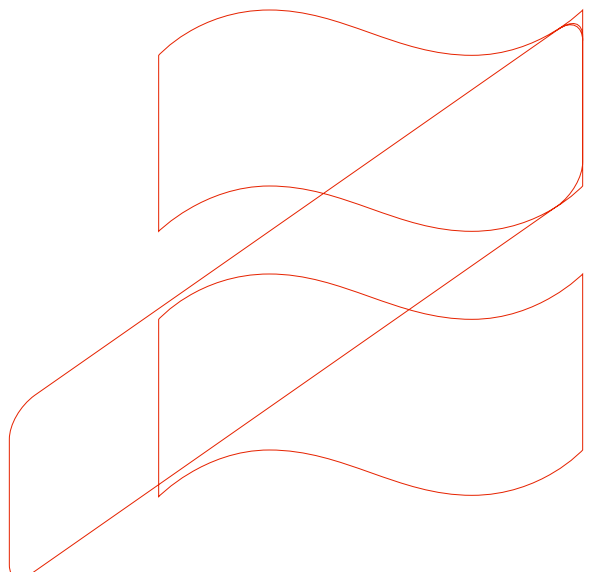
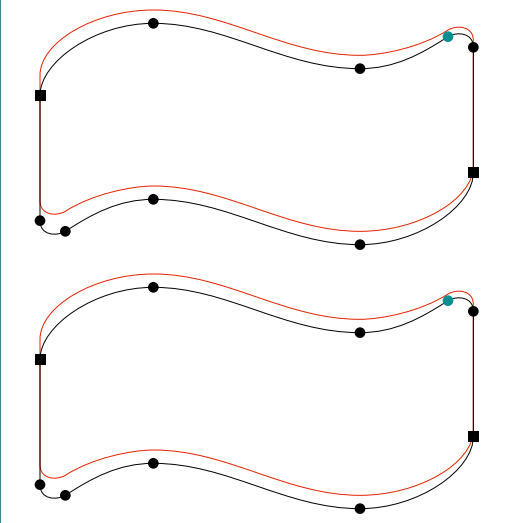

PROGRAM

.....
Program Black | guilingleft | RoboFog Sketches | 2013 | Emigre Fonts

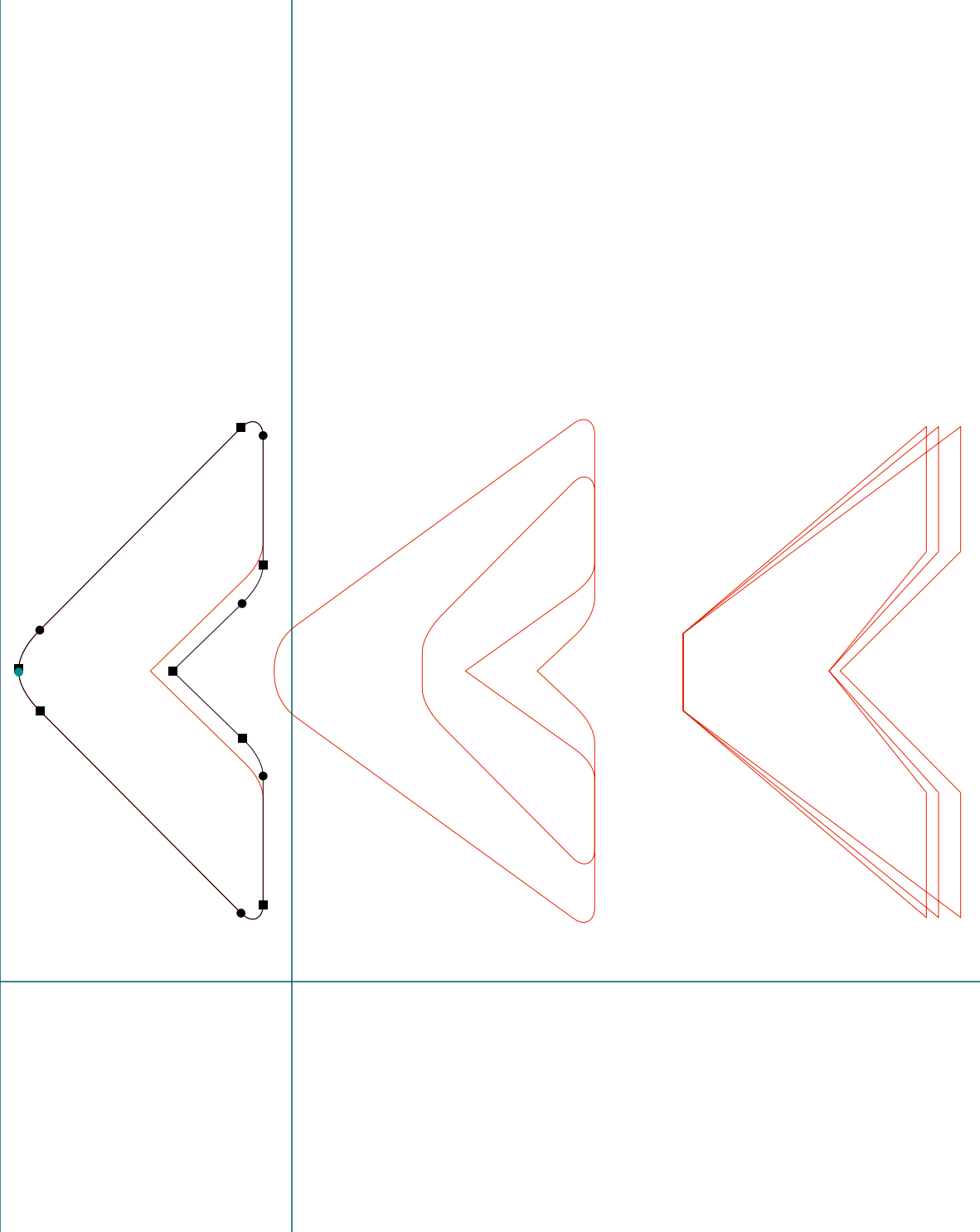

PROGRAM

Program Black | circumflex | RoboFog Sketches | 2013 | Emigre Fonts

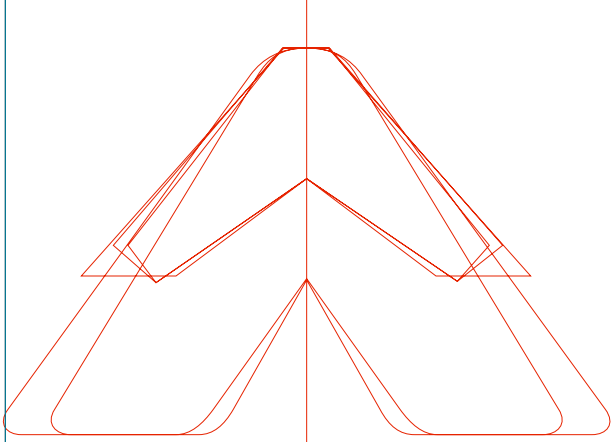
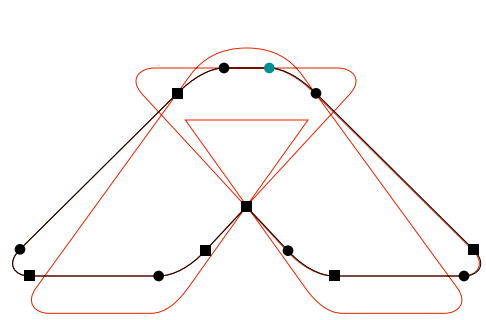

PROGRAM

.....
Program Black | cedilla | RoboFog Sketches | 2013 | Emigre Fonts

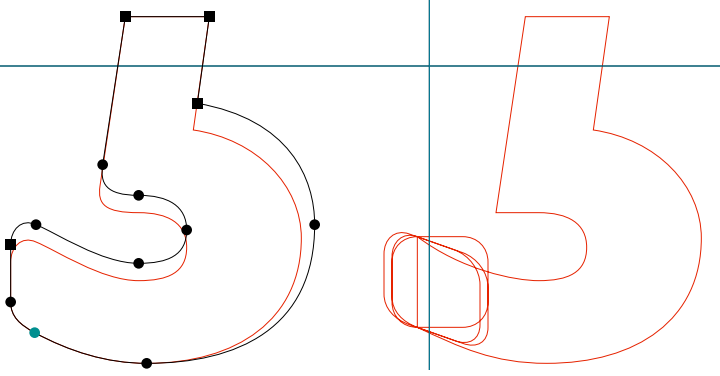

PROGRAM

.....
Program Black | ogonek | RoboFog Sketches | 2013 | Emigre Fonts

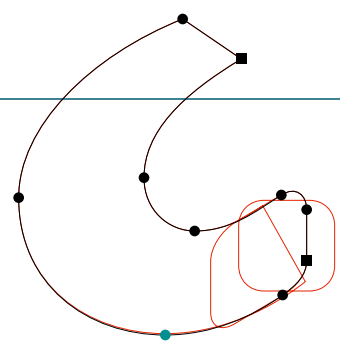

PROGRAM

Program NarRegular | dollar | RoboFog Sketches | 2013 | Emigre Fonts

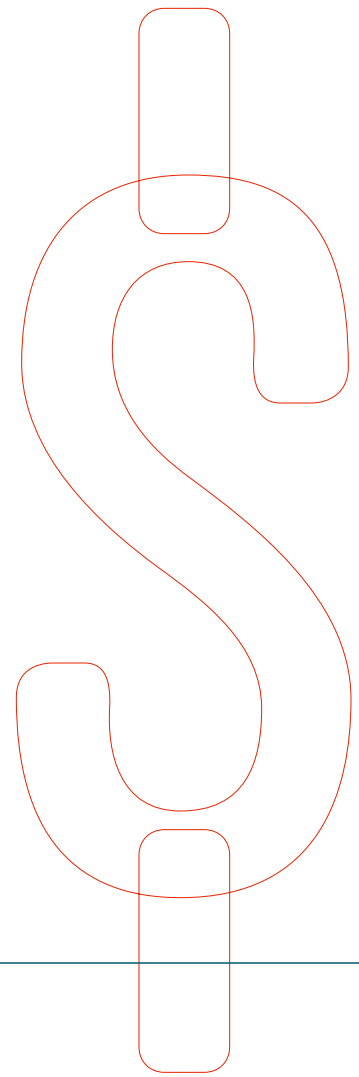
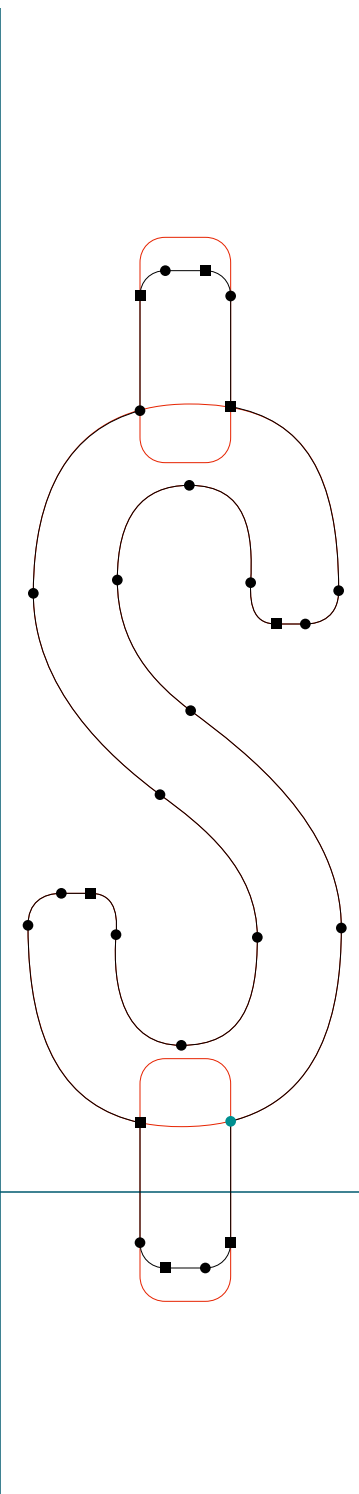

PROGRAM

.....
Program NarRegular | ampersand | RoboFog Sketches | 2013 | Emigre Fonts

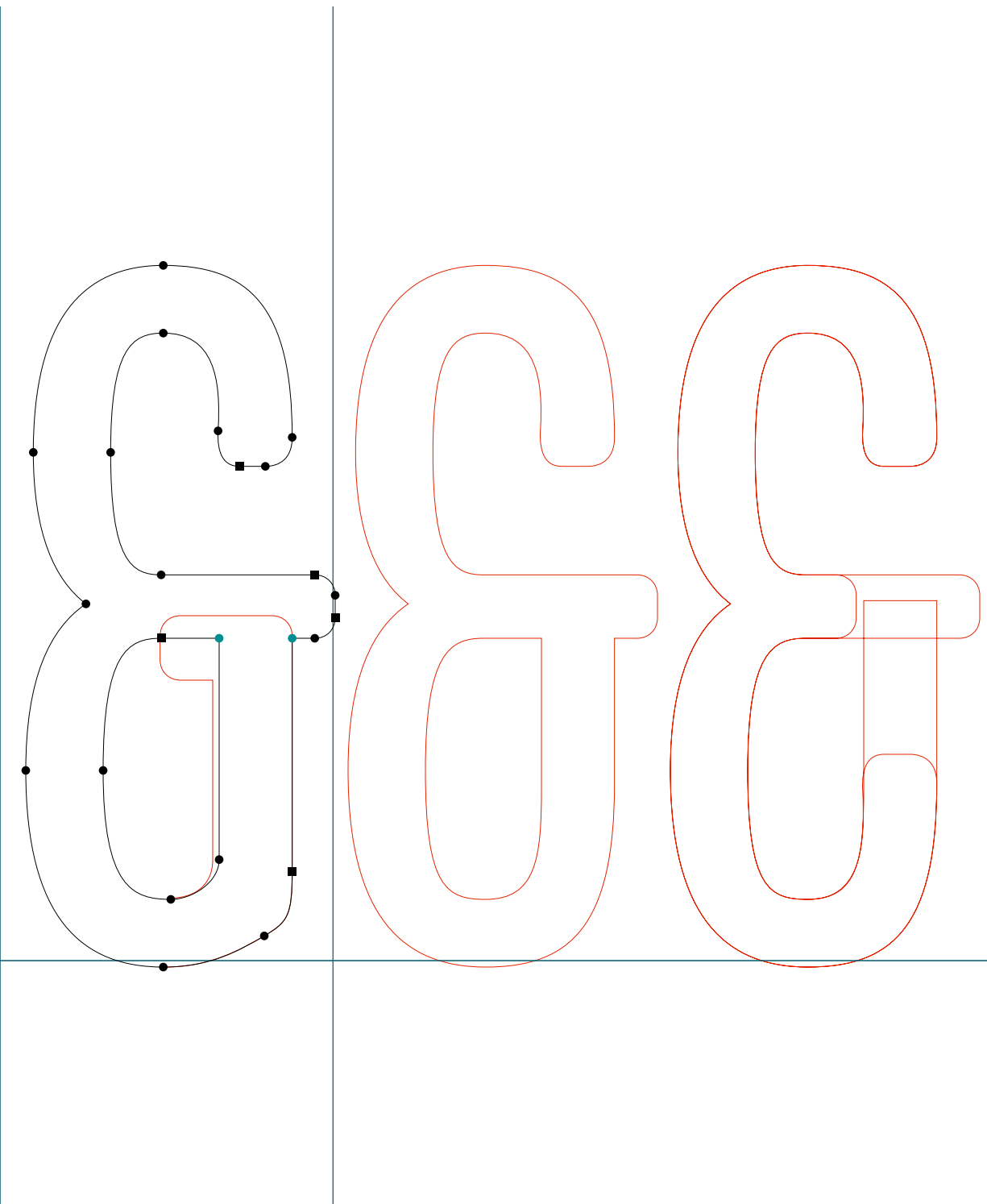

PROGRAM

.....
Program NarRegular | two | RoboFog Sketches | 2013 | Emigre Fonts

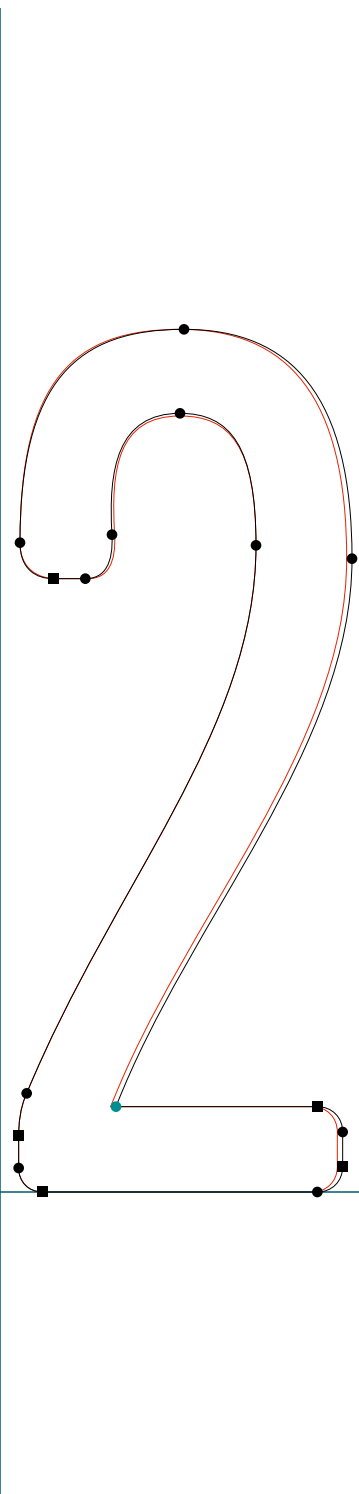

PROGRAM

.....
Program NarRegular | three | RoboFog Sketches | 2013 | Emigre Fonts

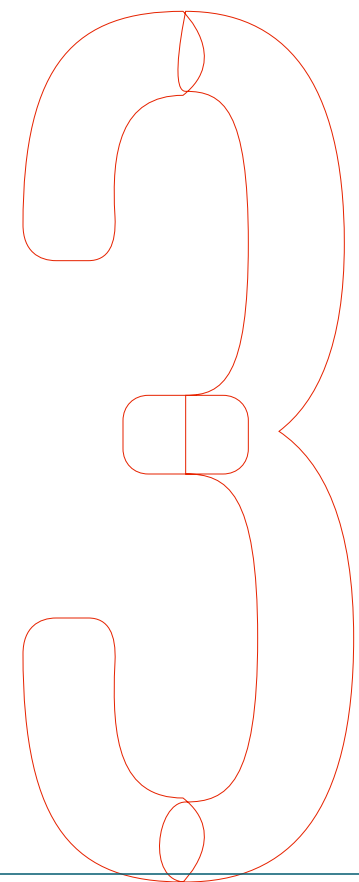
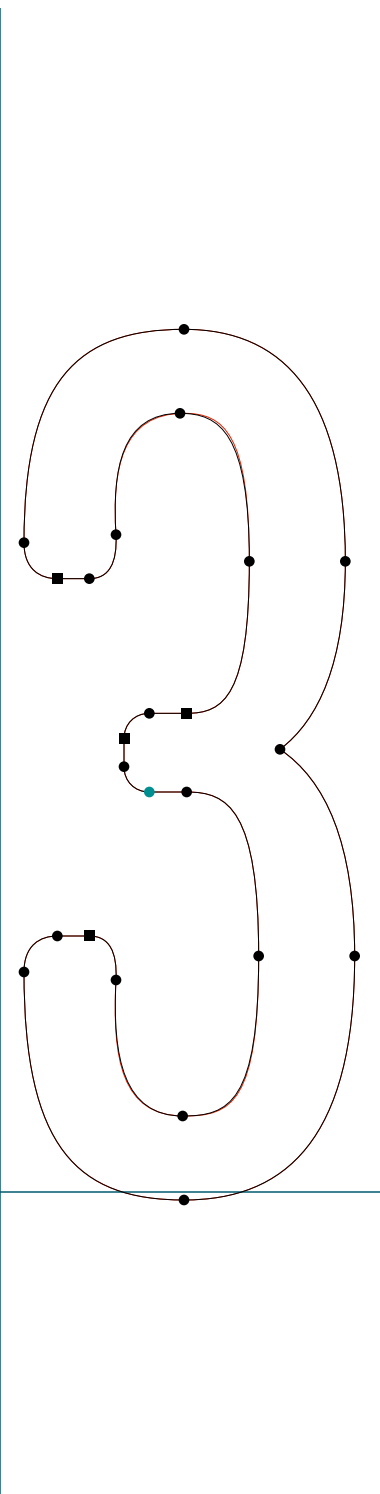

PROGRAM

Program NarRegular | five | RoboFog Sketches | 2013 | Emigre Fonts

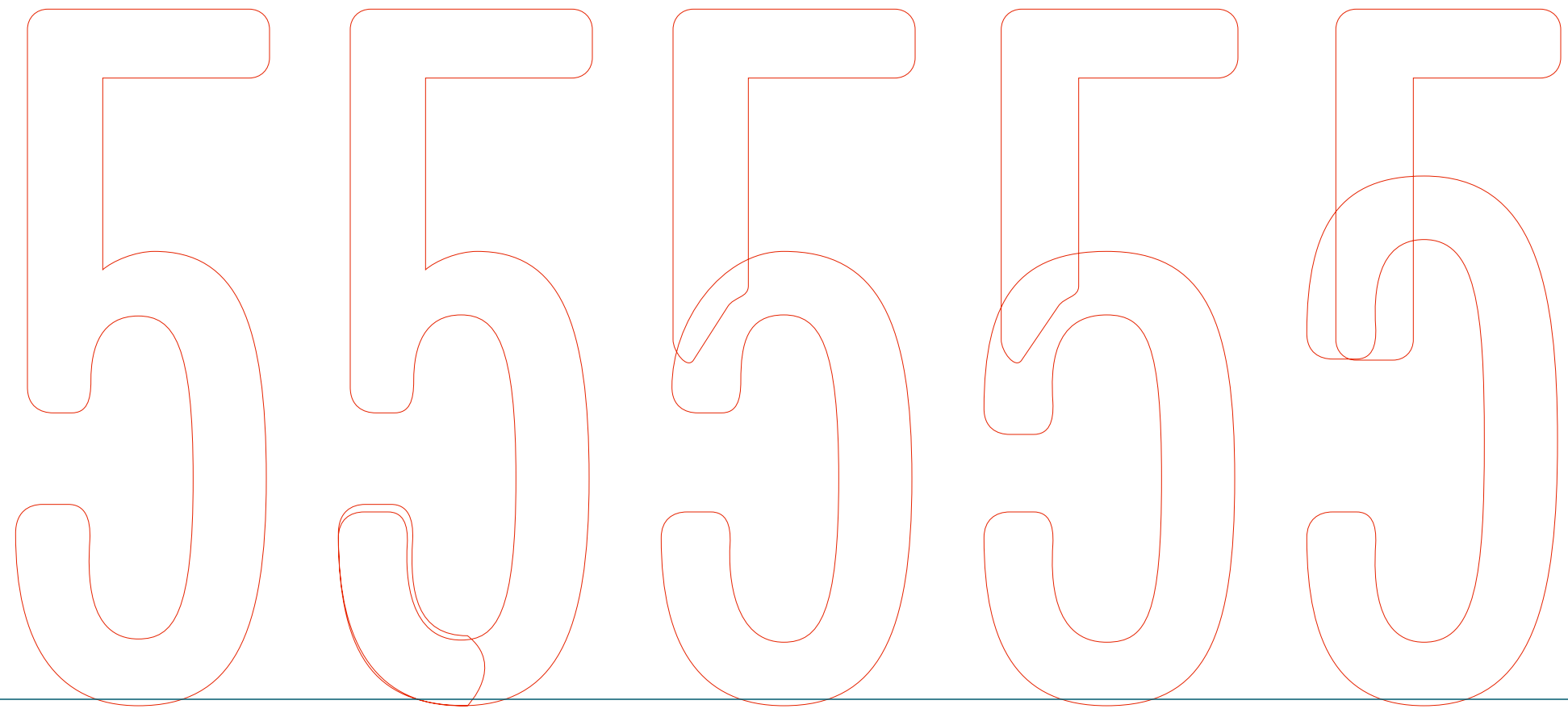
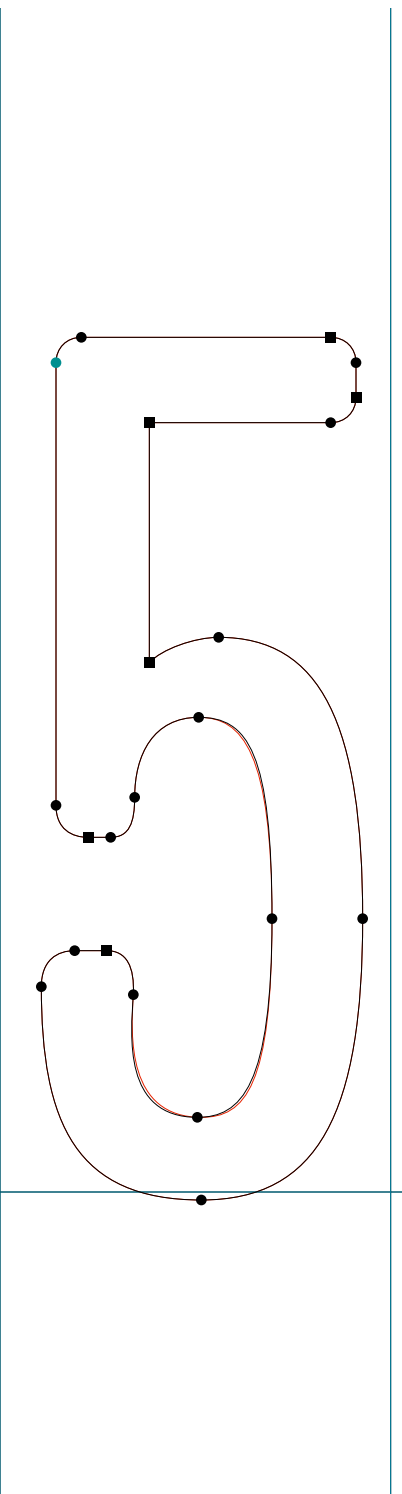

PROGRAM

.....
Program NarRegular | six | RoboFog Sketches | 2013 | Emigre Fonts

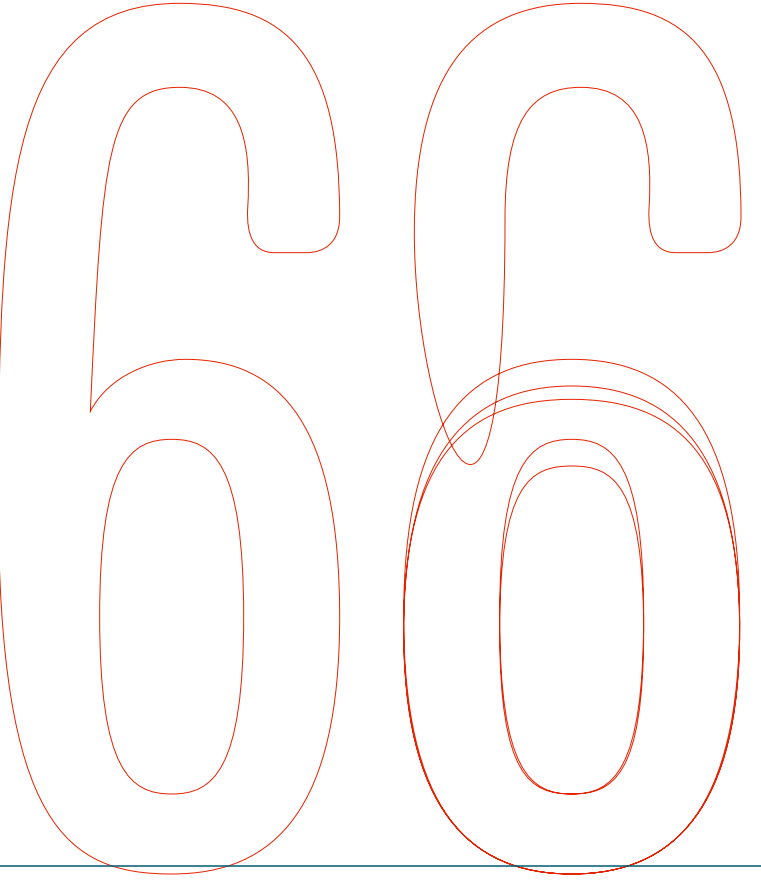
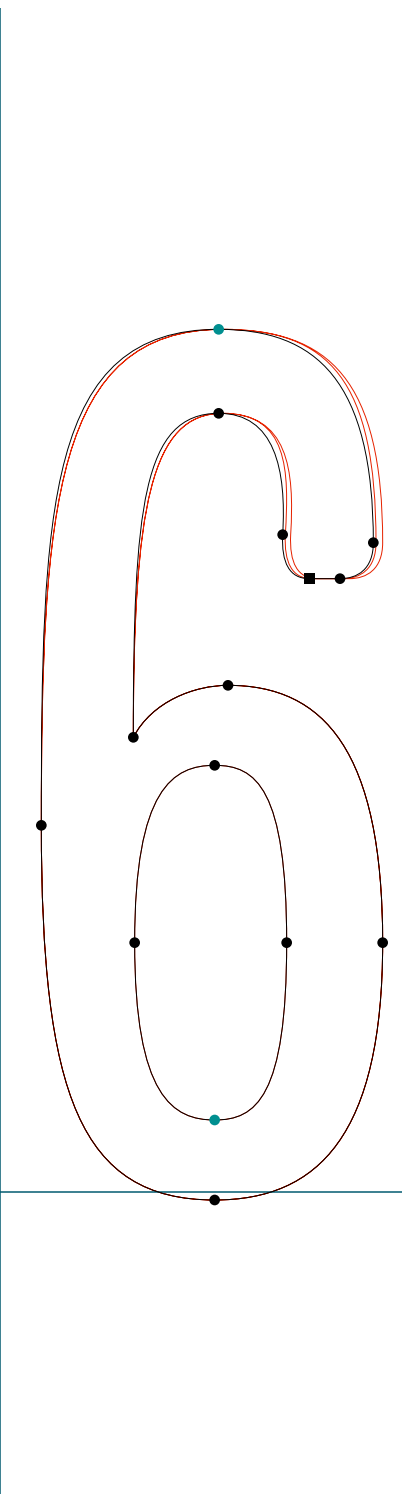

PROGRAM

.....
Program NarRegular | eight | RoboFog Sketches | 2013 | Emigre Fonts

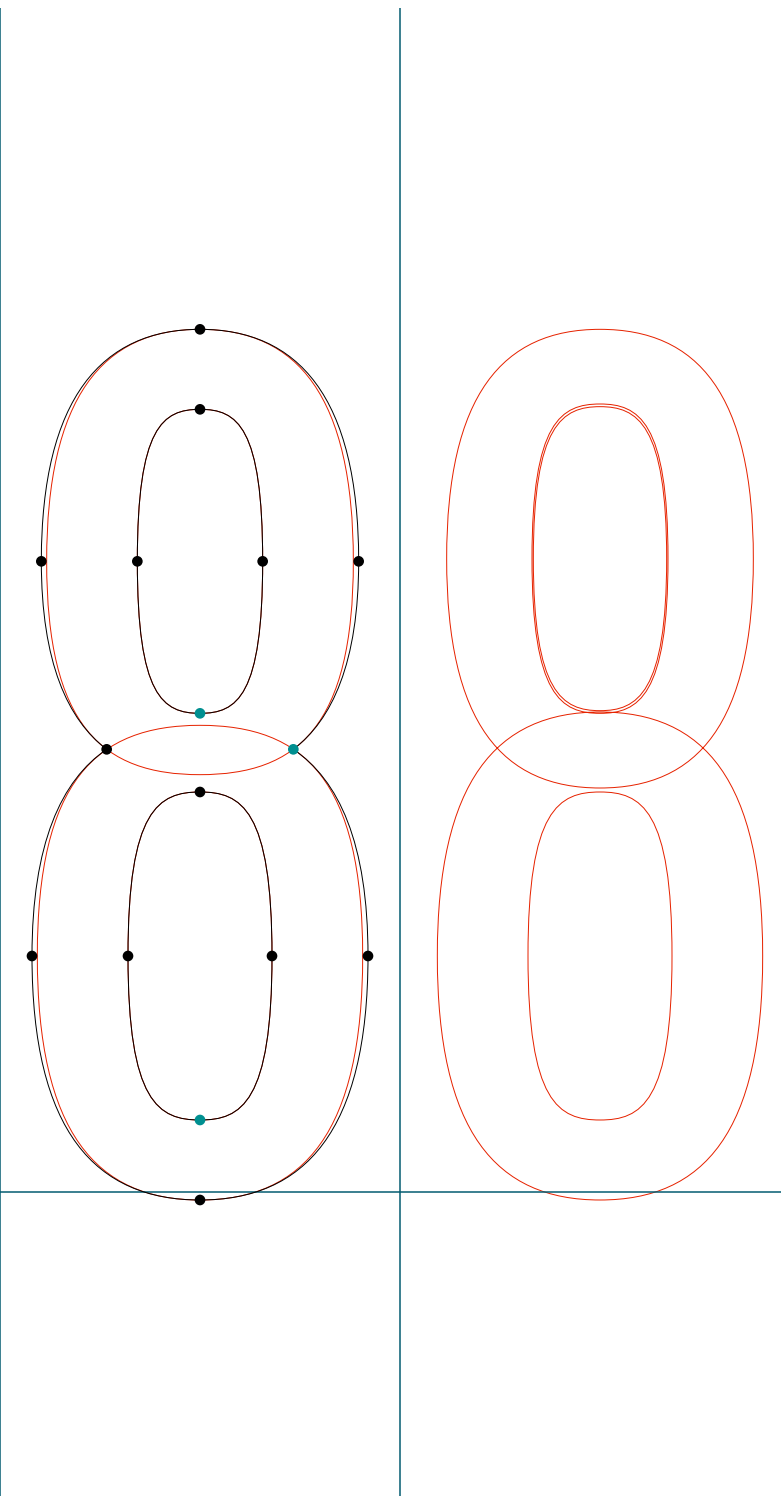

PROGRAM

.....
Program NarRegular | A | RoboFog Sketches | 2013 | Emigre Fonts

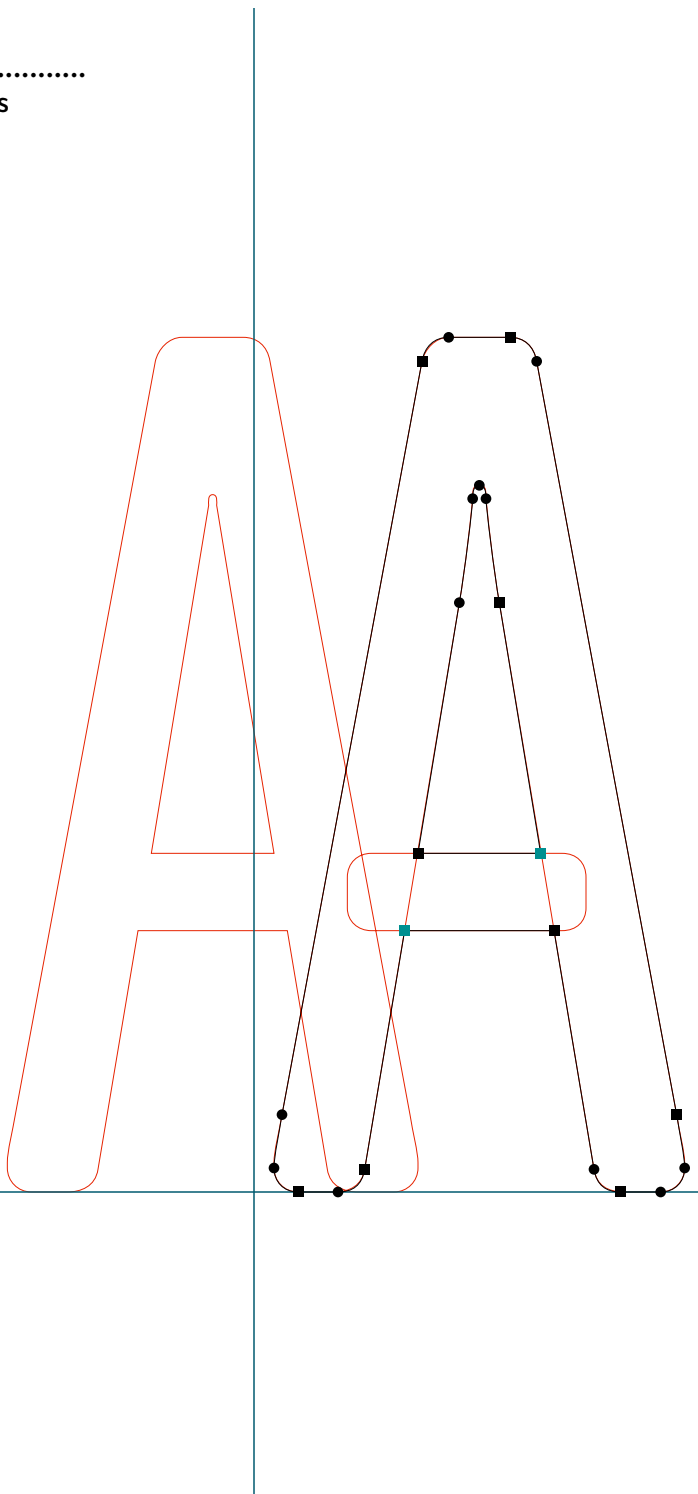

PROGRAM

.....
Program NarRegular | C | RoboFog Sketches | 2013 | Emigre Fonts

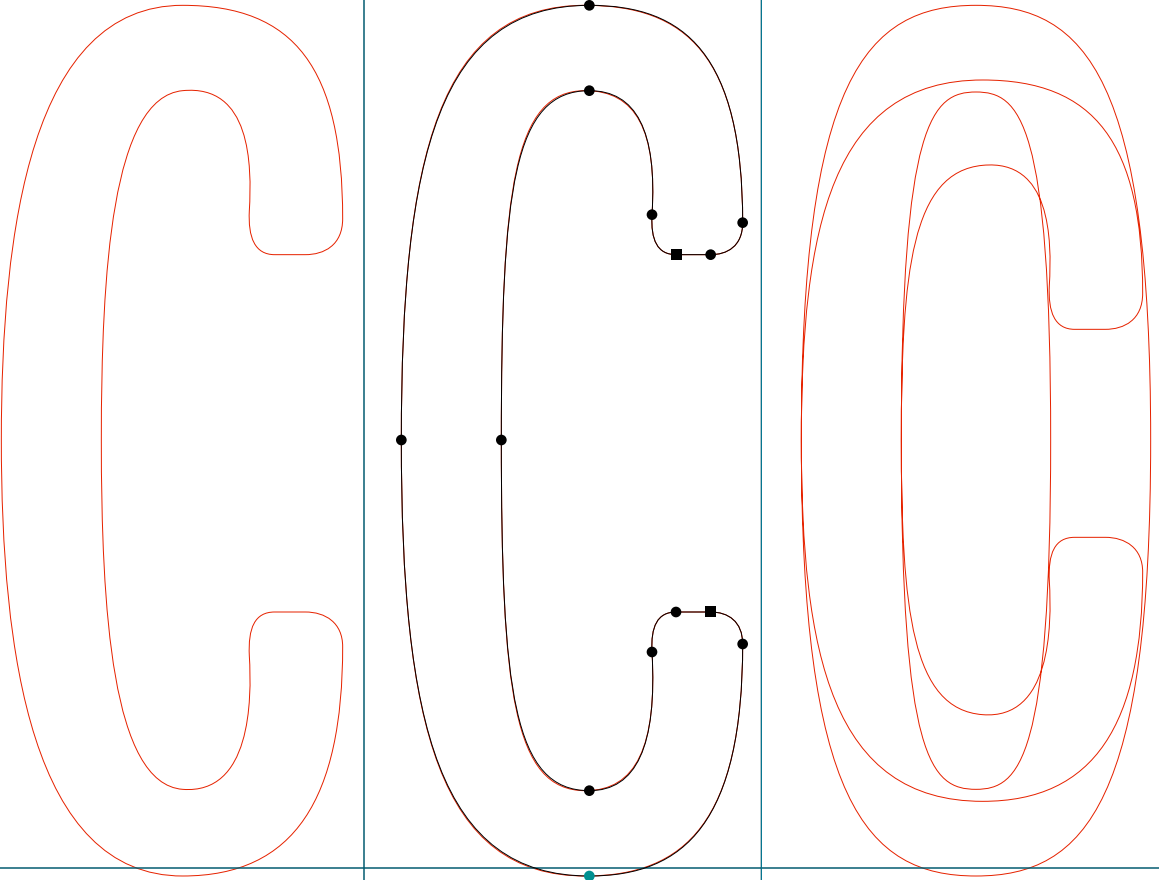

PROGRAM

.....
Program NarRegular | G | RoboFog Sketches | 2013 | Emigre Fonts

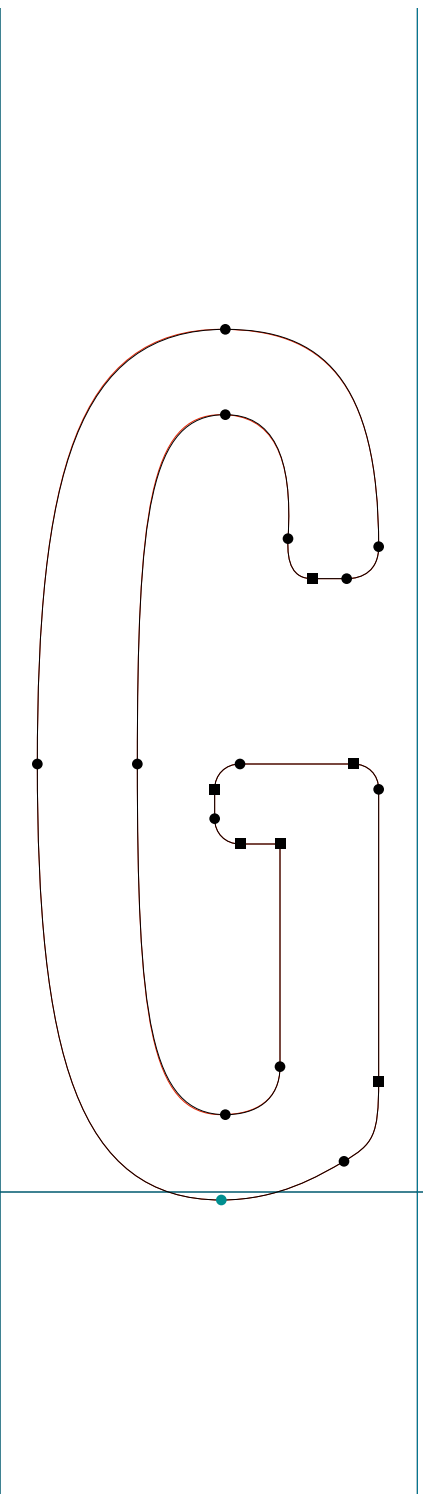

PROGRAM

.....
Program NarRegular | J | RoboFog Sketches | 2013 | Emigre Fonts

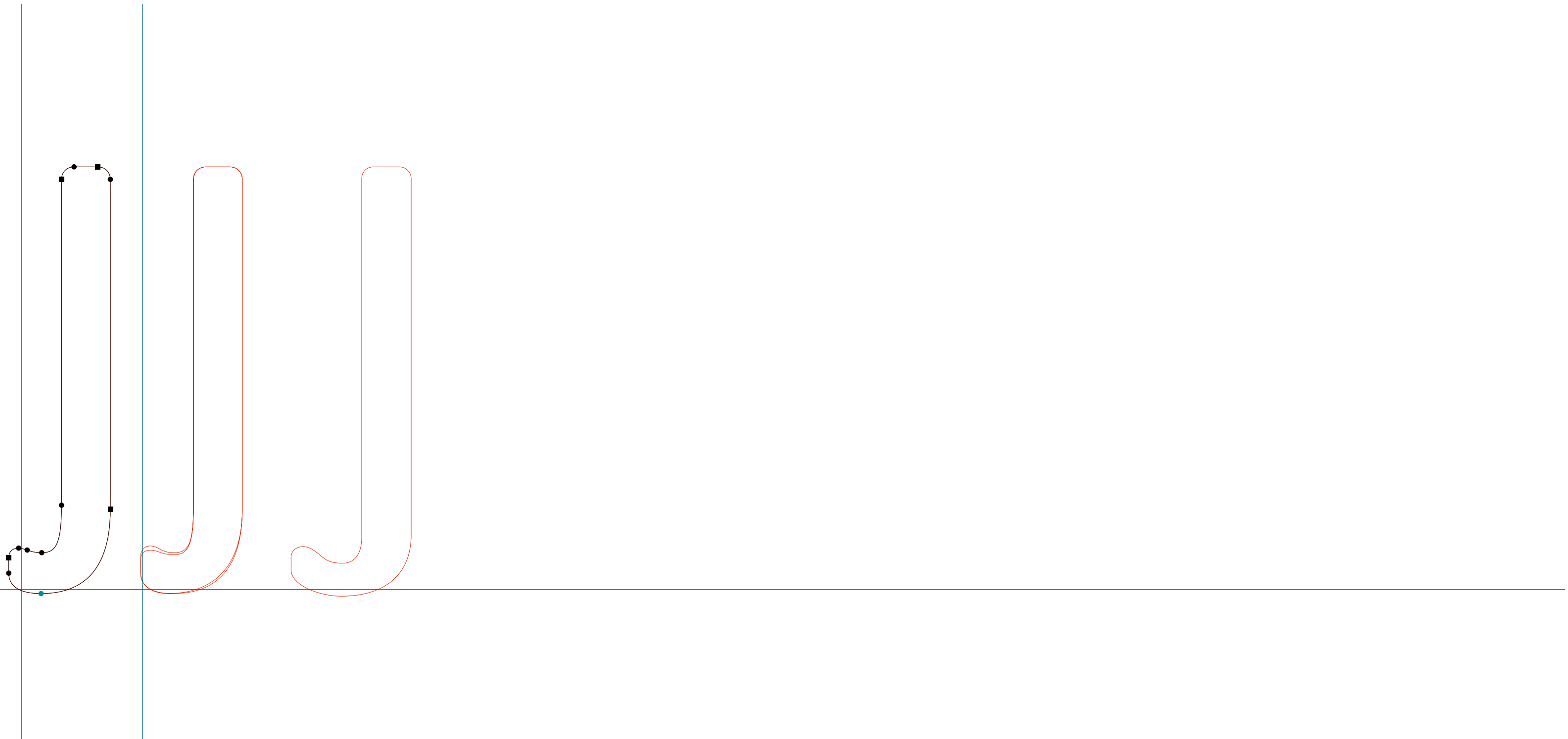

PROGRAM

.....
Program NarRegular | Q | RoboFog Sketches | 2013 | Emigre Fonts

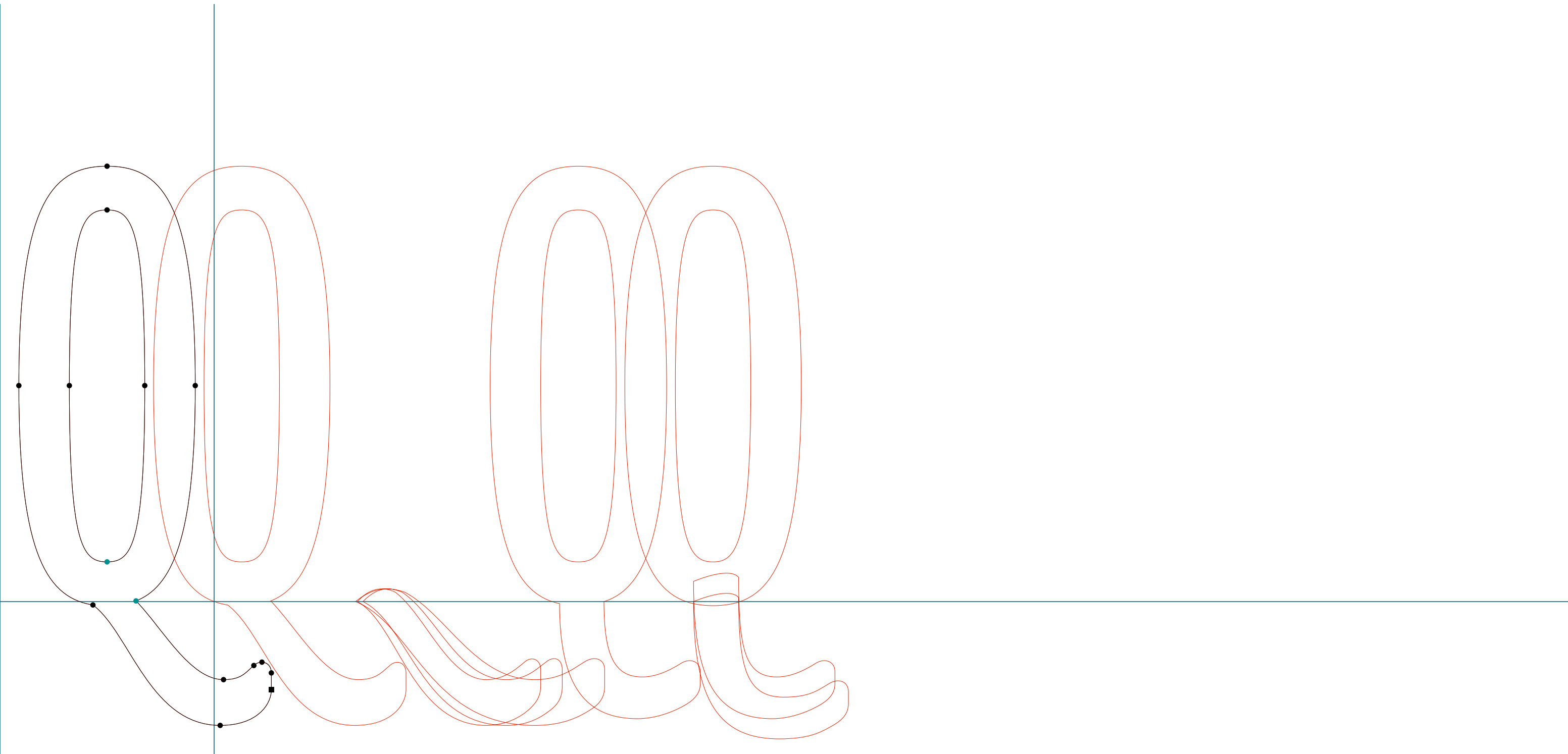

PROGRAM

.....
Program NarRegular | S | RoboFog Sketches | 2013 | Emigre Fonts

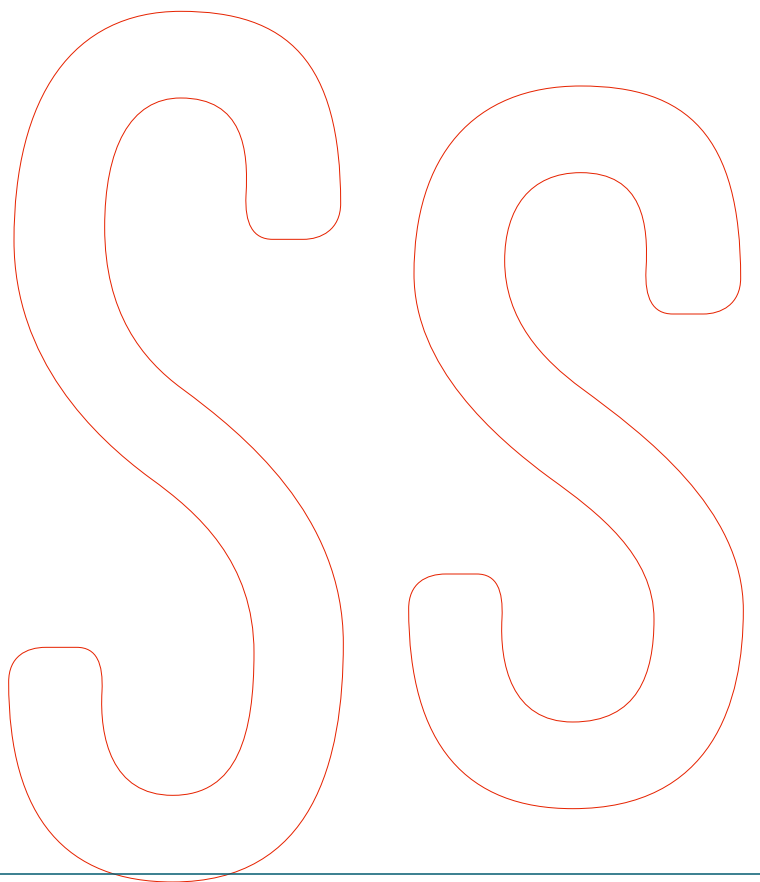
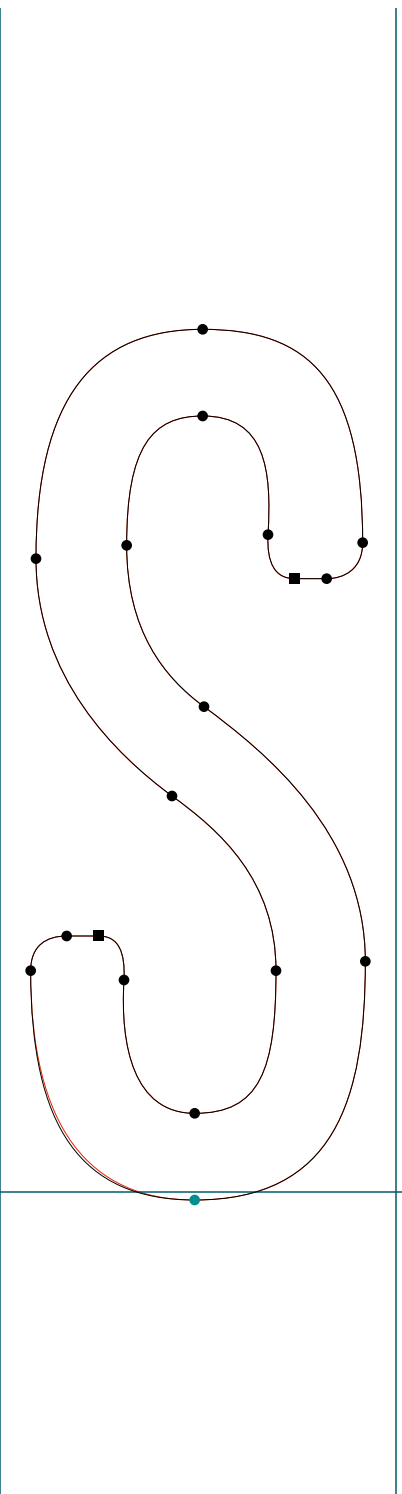

PROGRAM

Program NarRegular | V | RoboFog Sketches | 2013 | Emigre Fonts

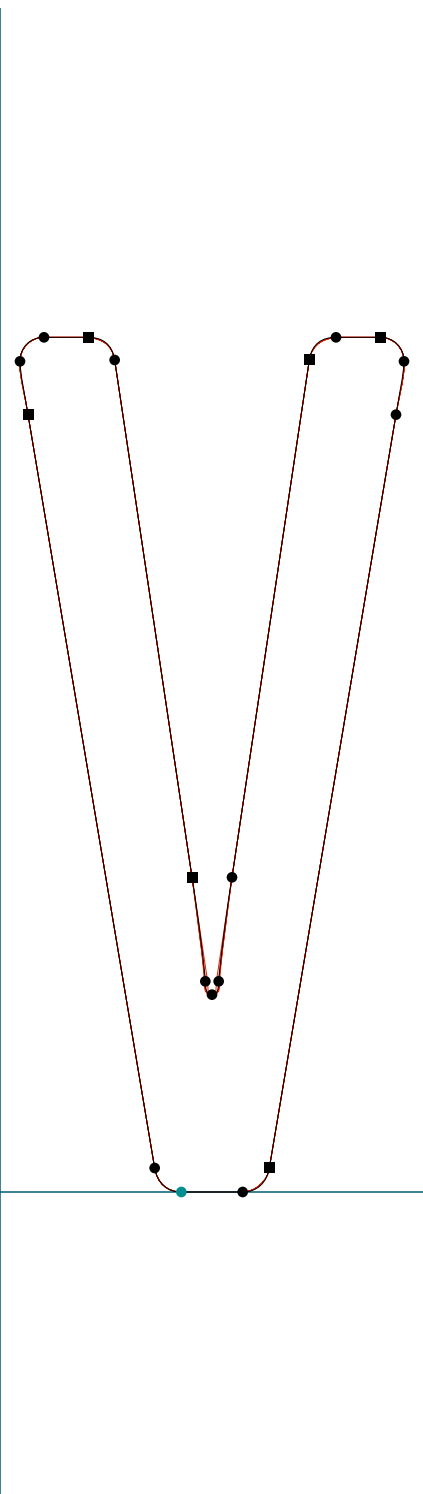

PROGRAM

.....
Program NarRegular | W | RoboFog Sketches | 2013 | Emigre Fonts

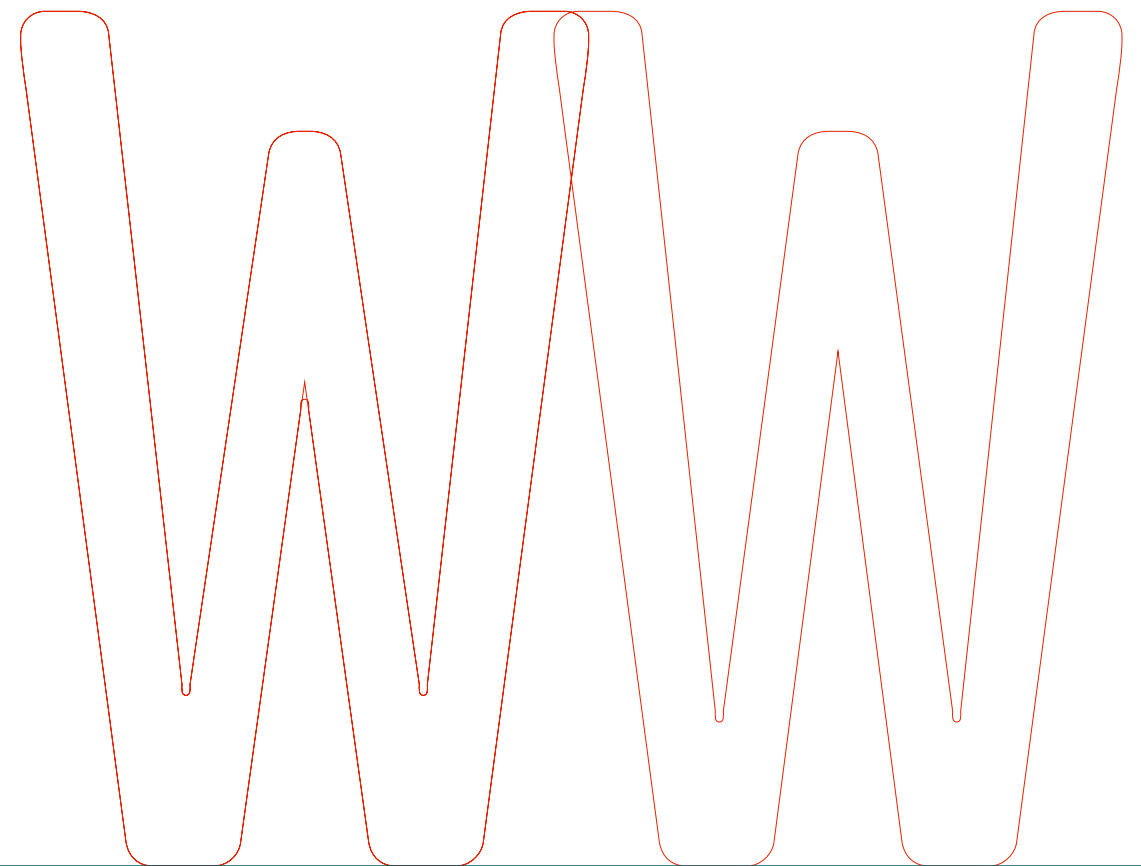
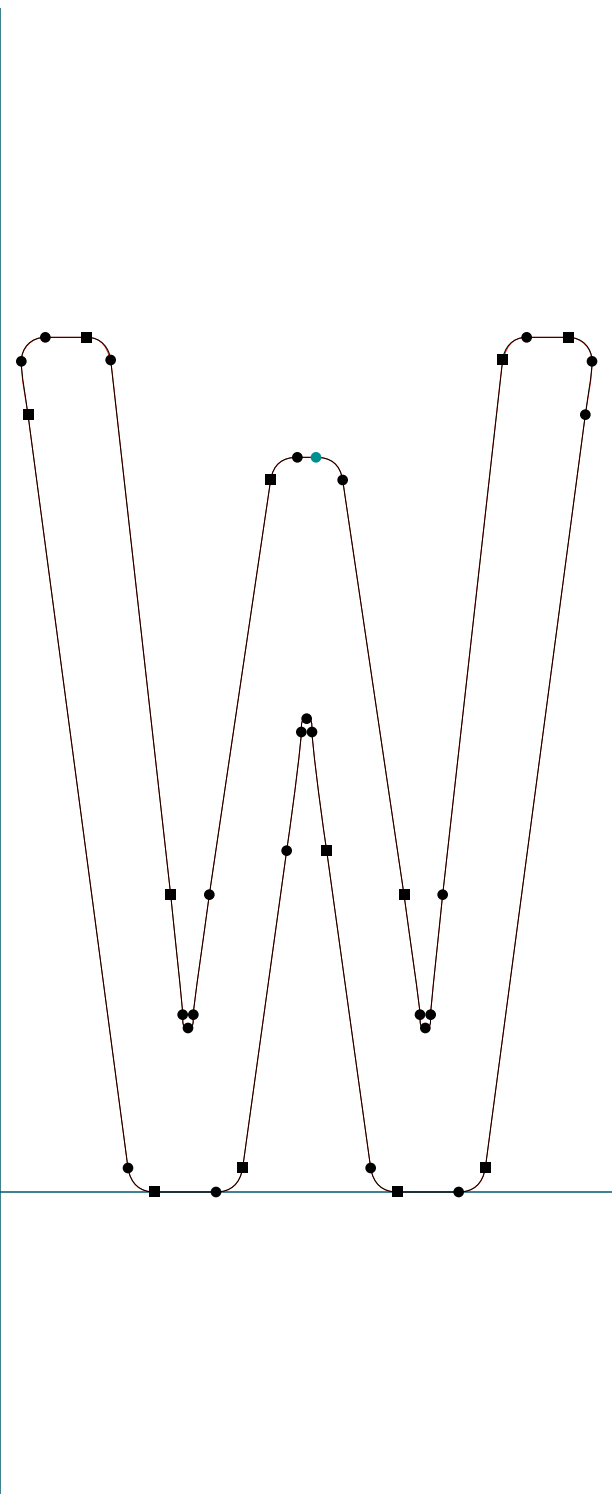

PROGRAM

.....
Program NarRegular | X | RoboFog Sketches | 2013 | Emigre Fonts

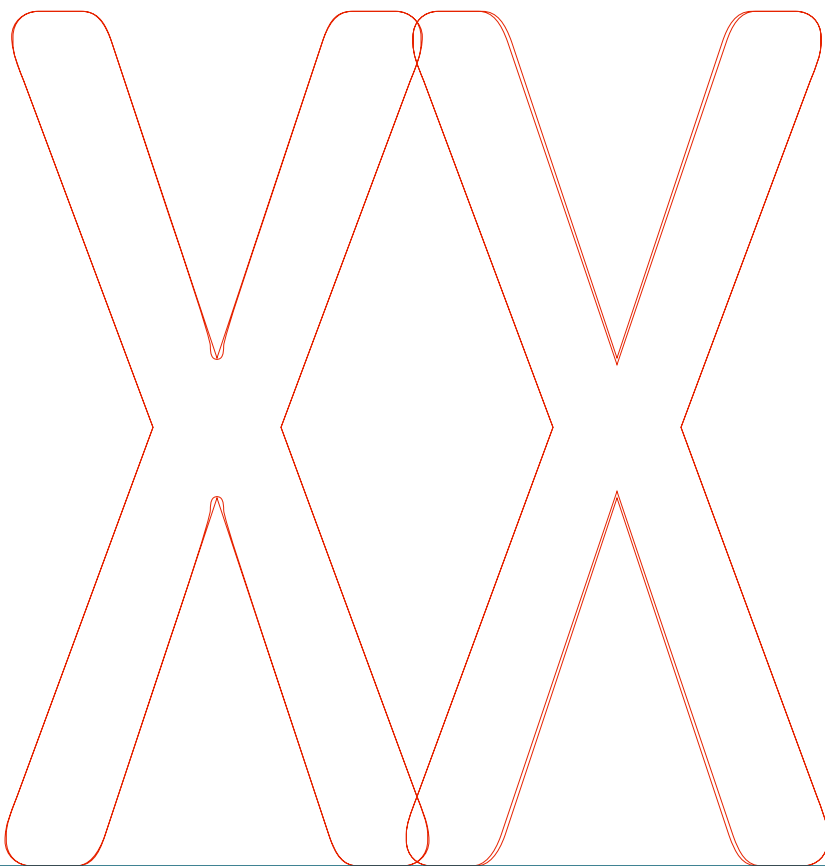
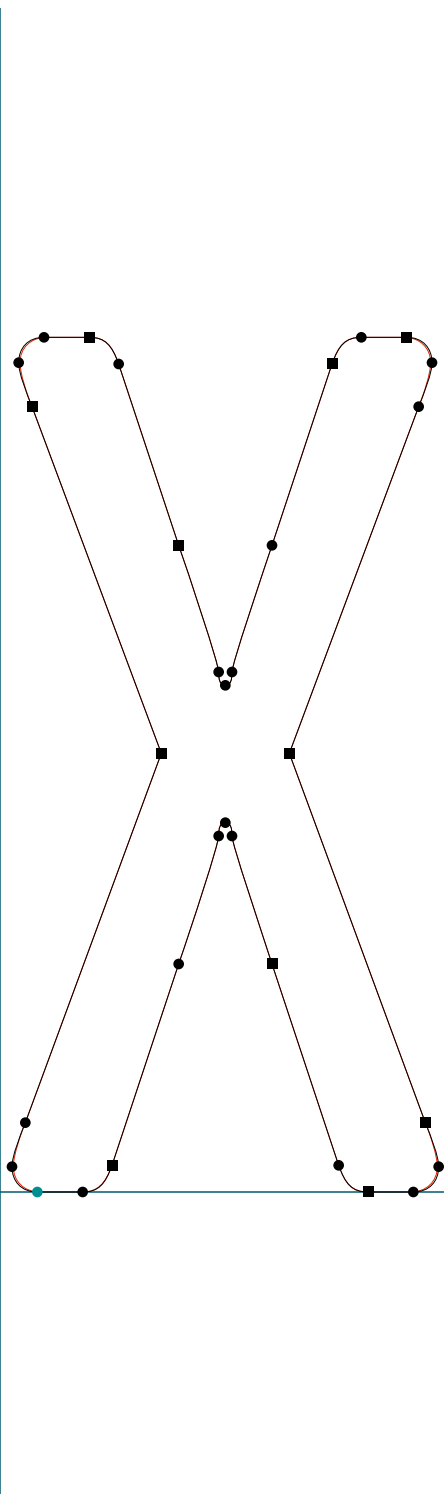

PROGRAM

.....
Program NarRegular | Y | RoboFog Sketches | 2013 | Emigre Fonts

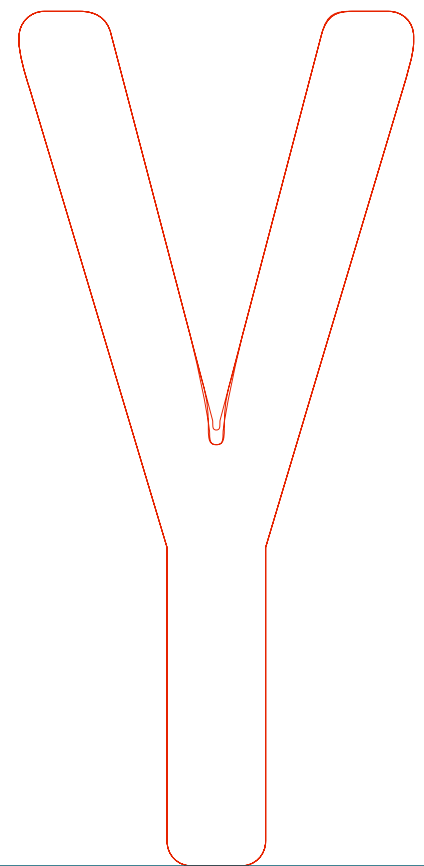
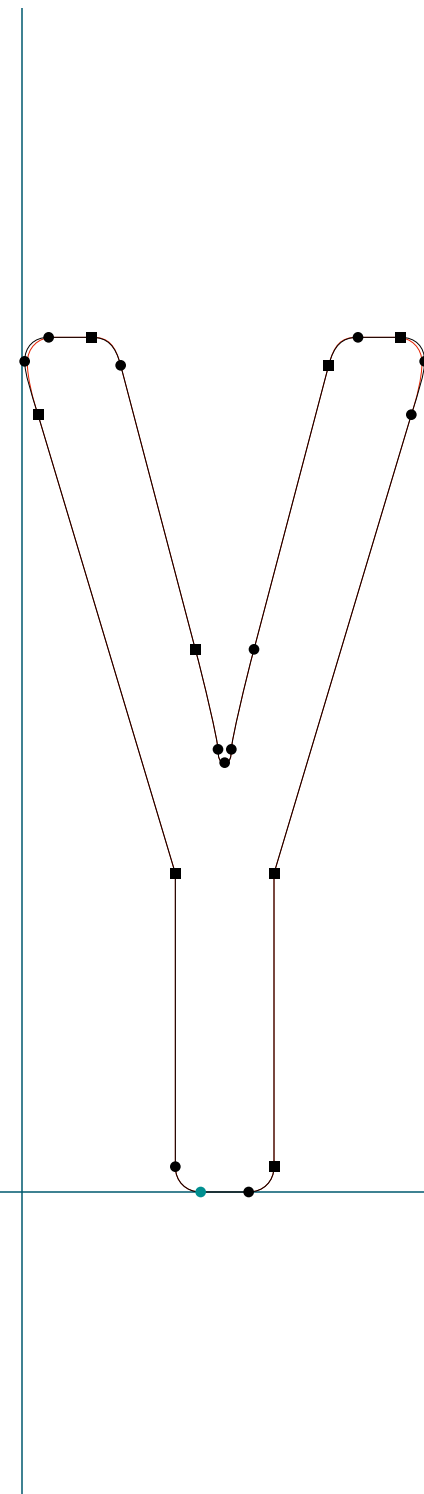

PROGRAM

.....
Program NarRegular | a | RoboFog Sketches | 2013 | Emigre Fonts

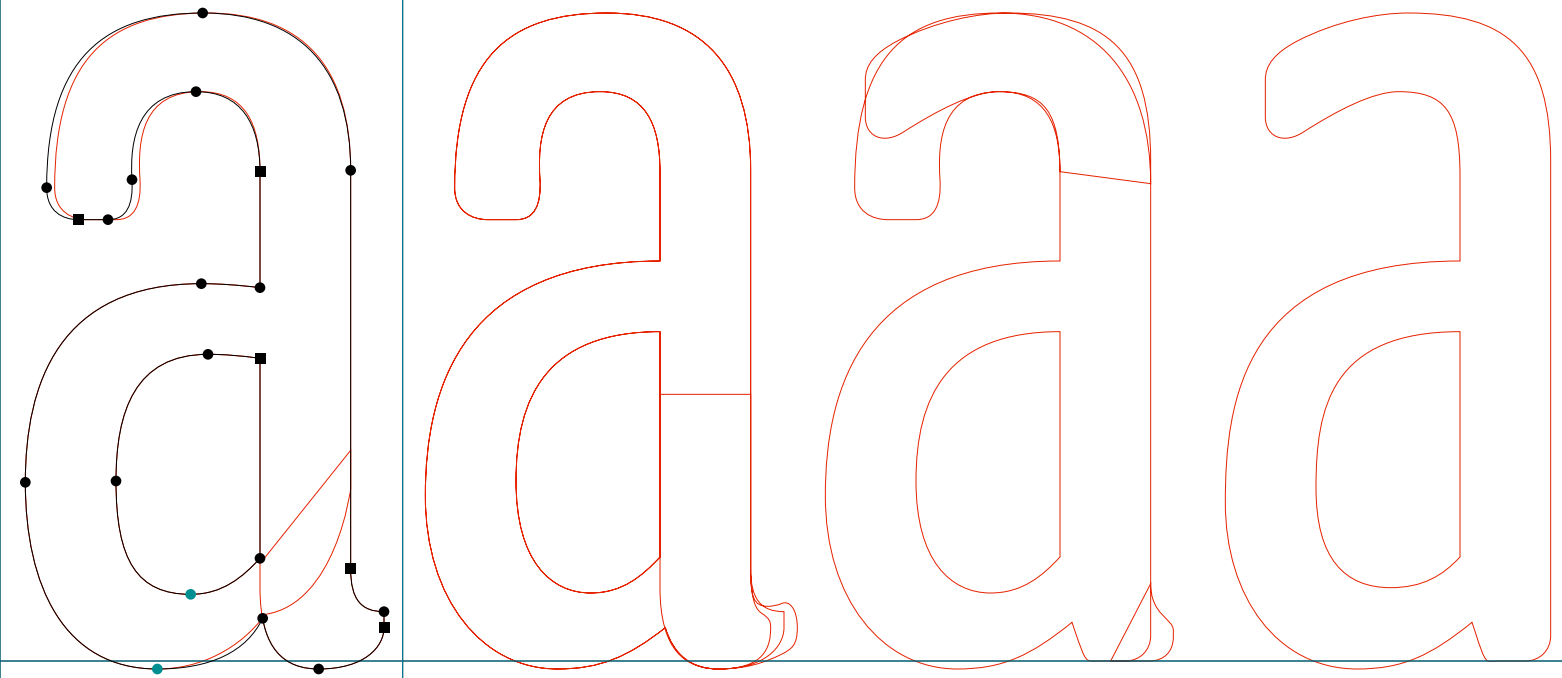

PROGRAM

Program NarRegular | b | RoboFog Sketches | 2013 | Emigre Fonts

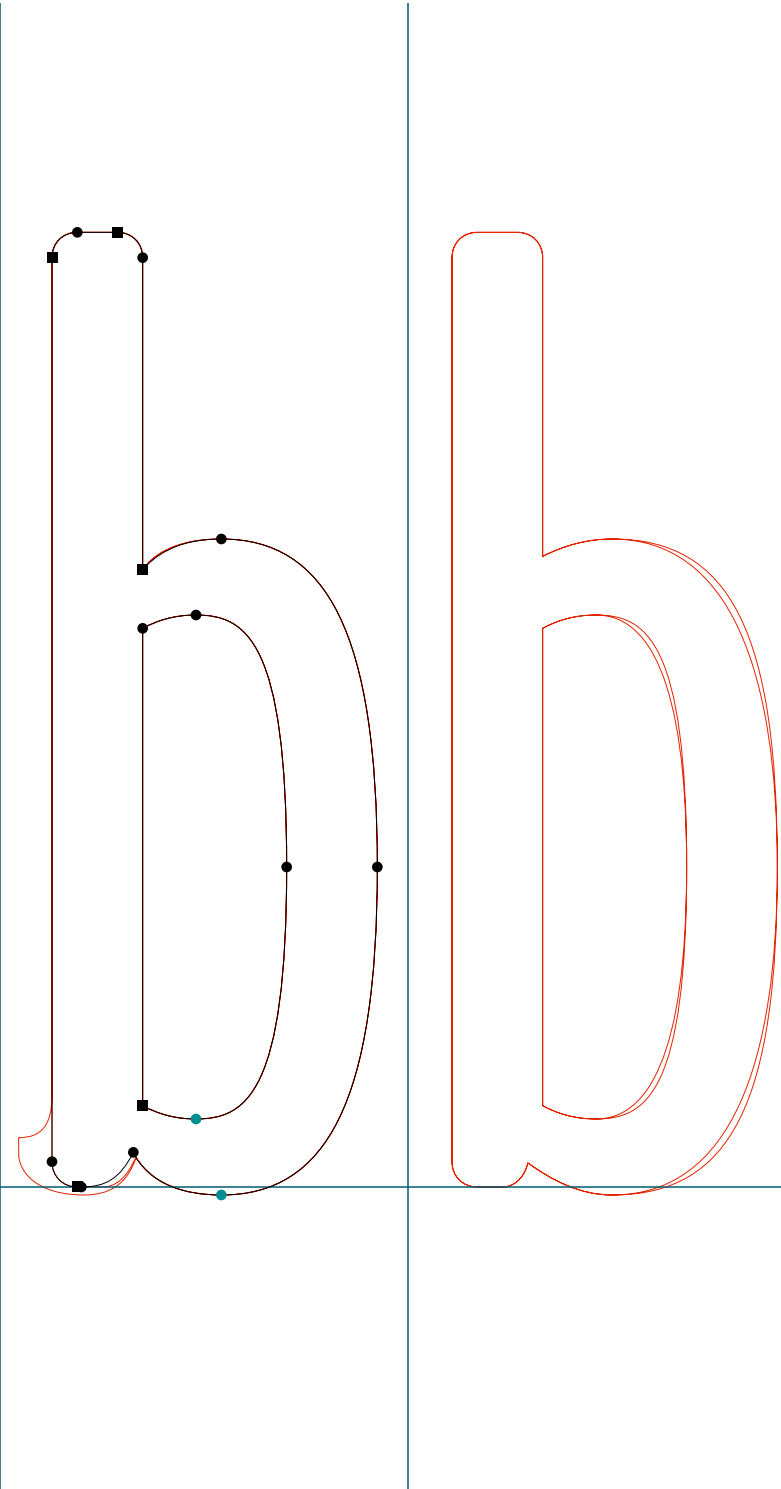

PROGRAM

.....
Program NarRegular | c | RoboFog Sketches | 2013 | Emigre Fonts

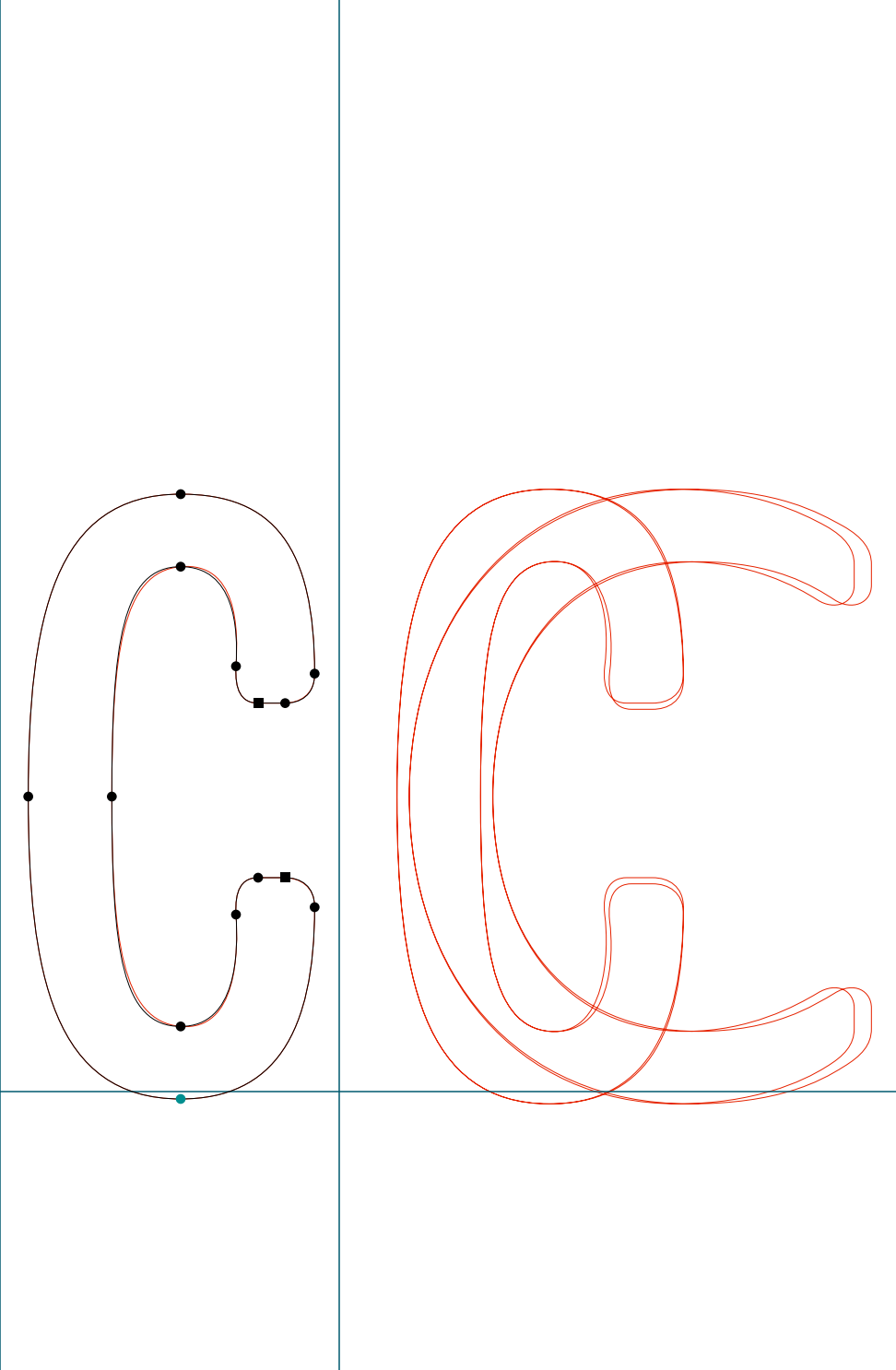

PROGRAM

Program NarRegular | d | RoboFog Sketches | 2013 | Emigre Fonts

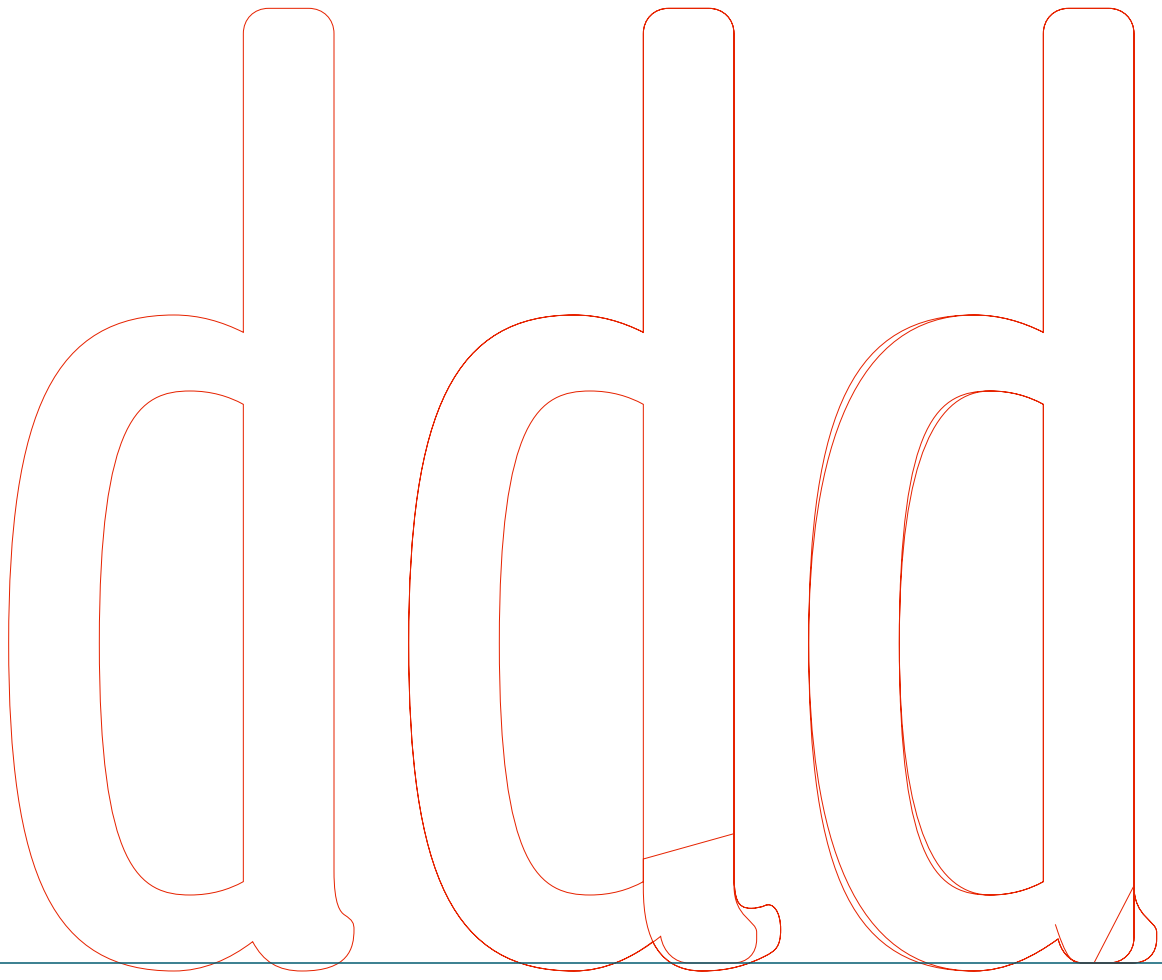
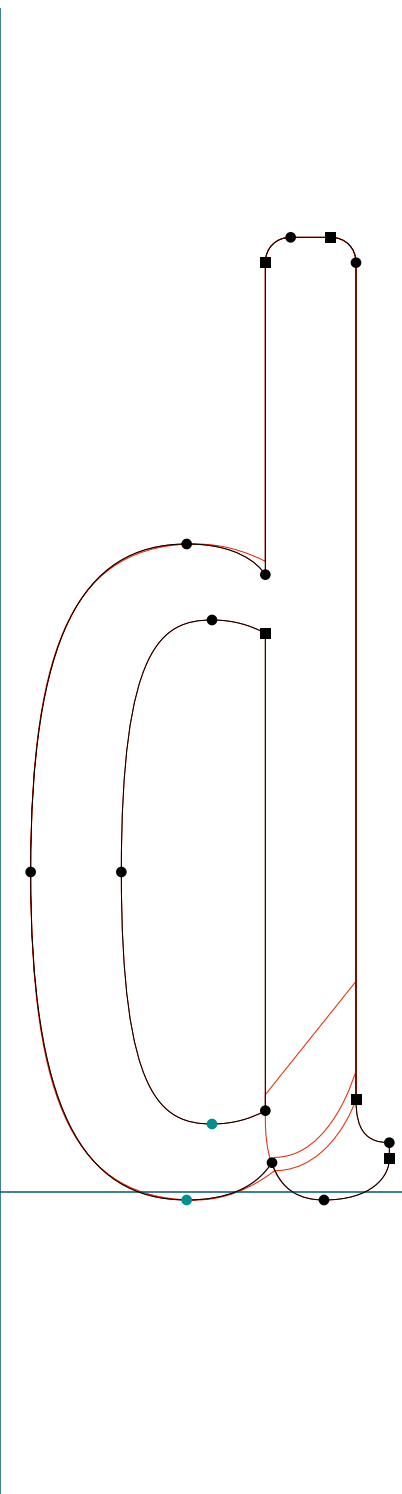

PROGRAM

.....
Program NarRegular | e | RoboFog Sketches | 2013 | Emigre Fonts

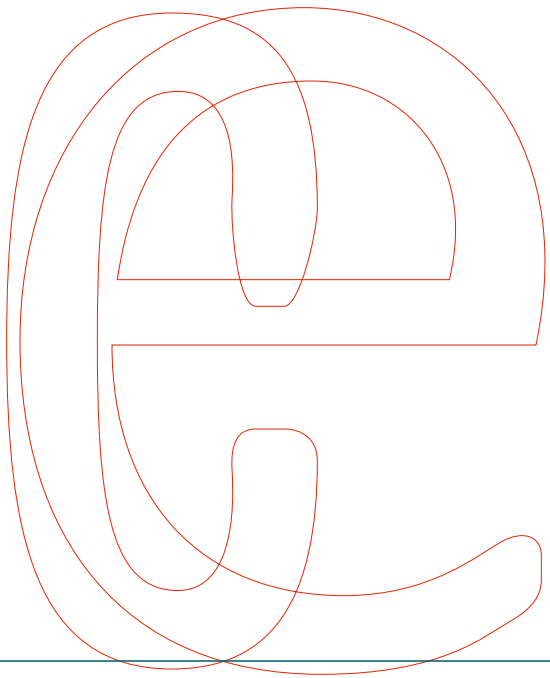
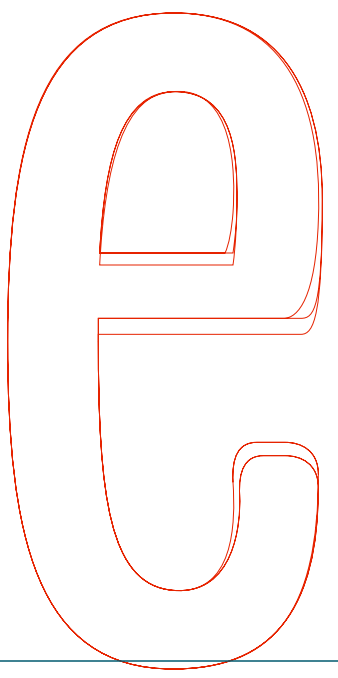
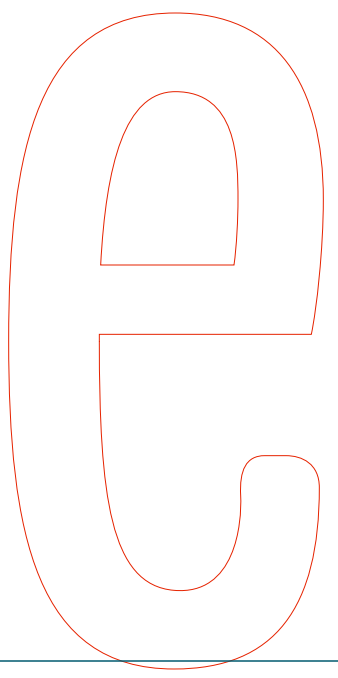
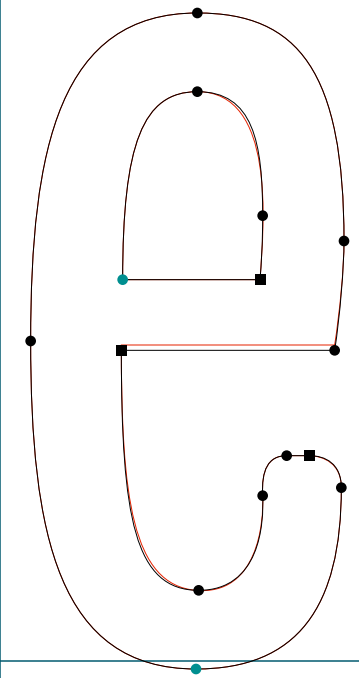

PROGRAM

Program NarRegular | f | RoboFog Sketches | 2013 | Emigre Fonts

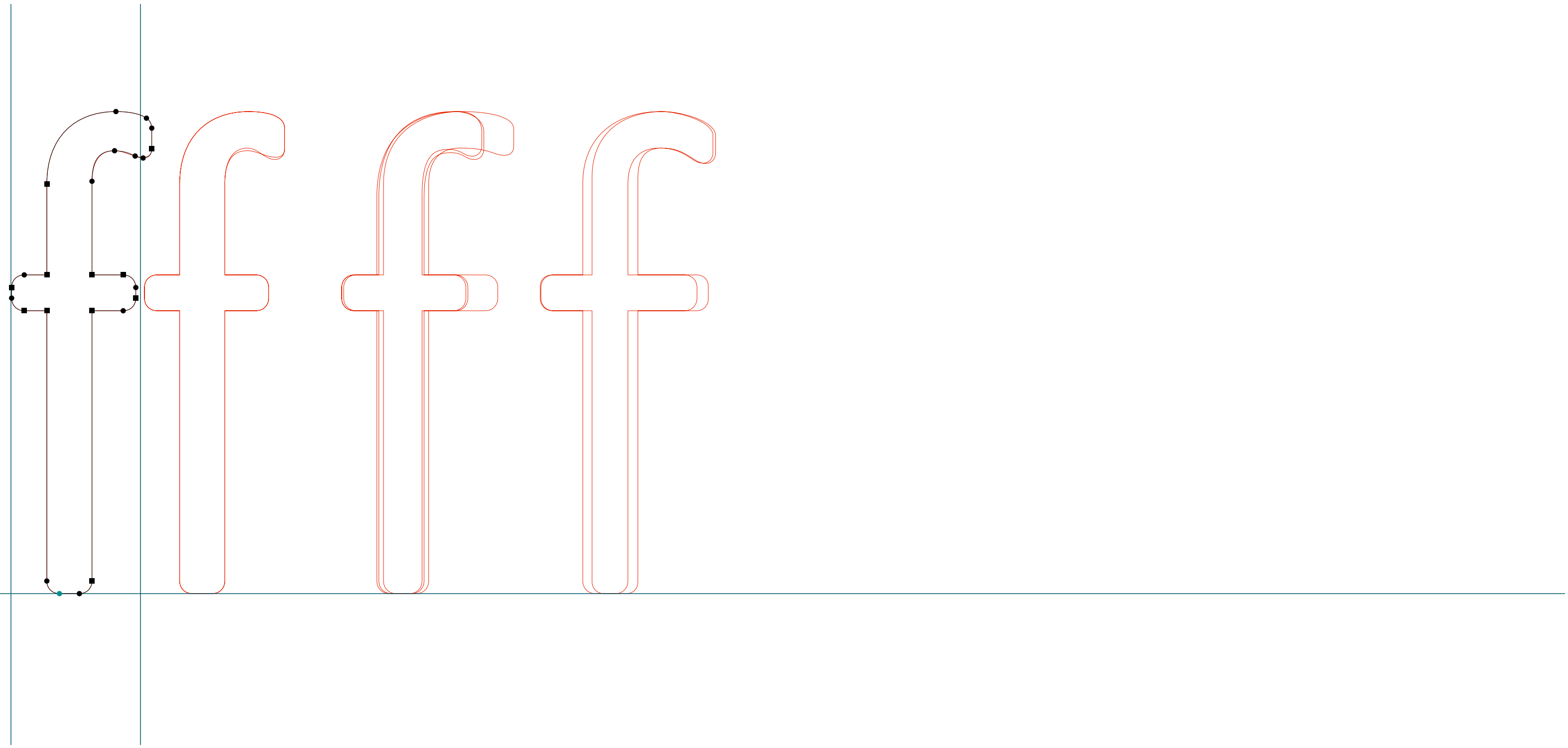

PROGRAM

.....
Program NarRegular | g | RoboFog Sketches | 2013 | Emigre Fonts

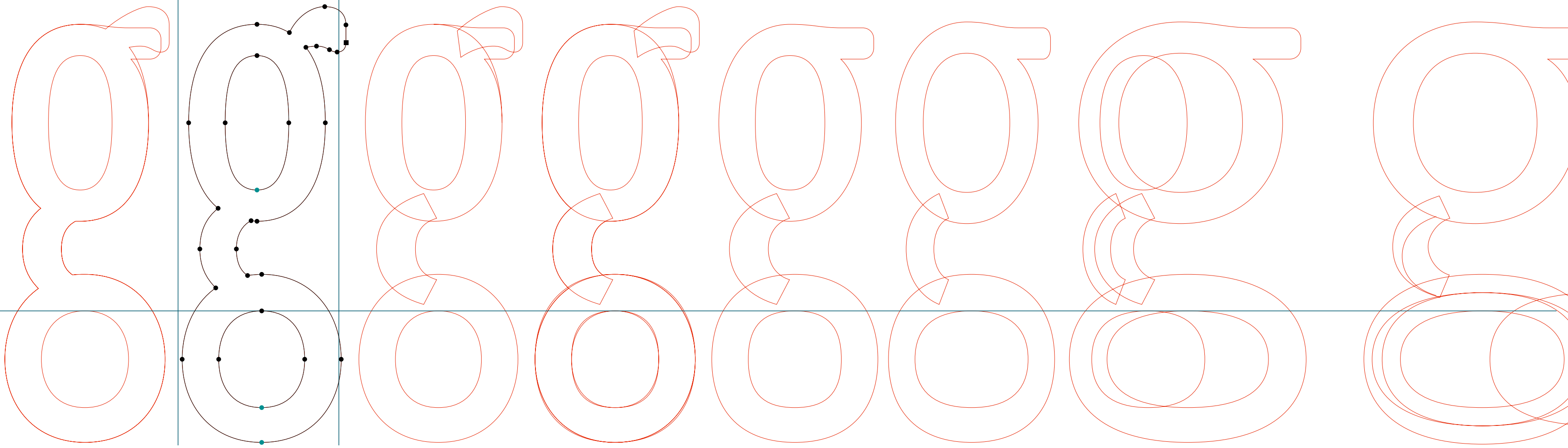

PROGRAM

.....
Program NarRegular | h | RoboFog Sketches | 2013 | Emigre Fonts

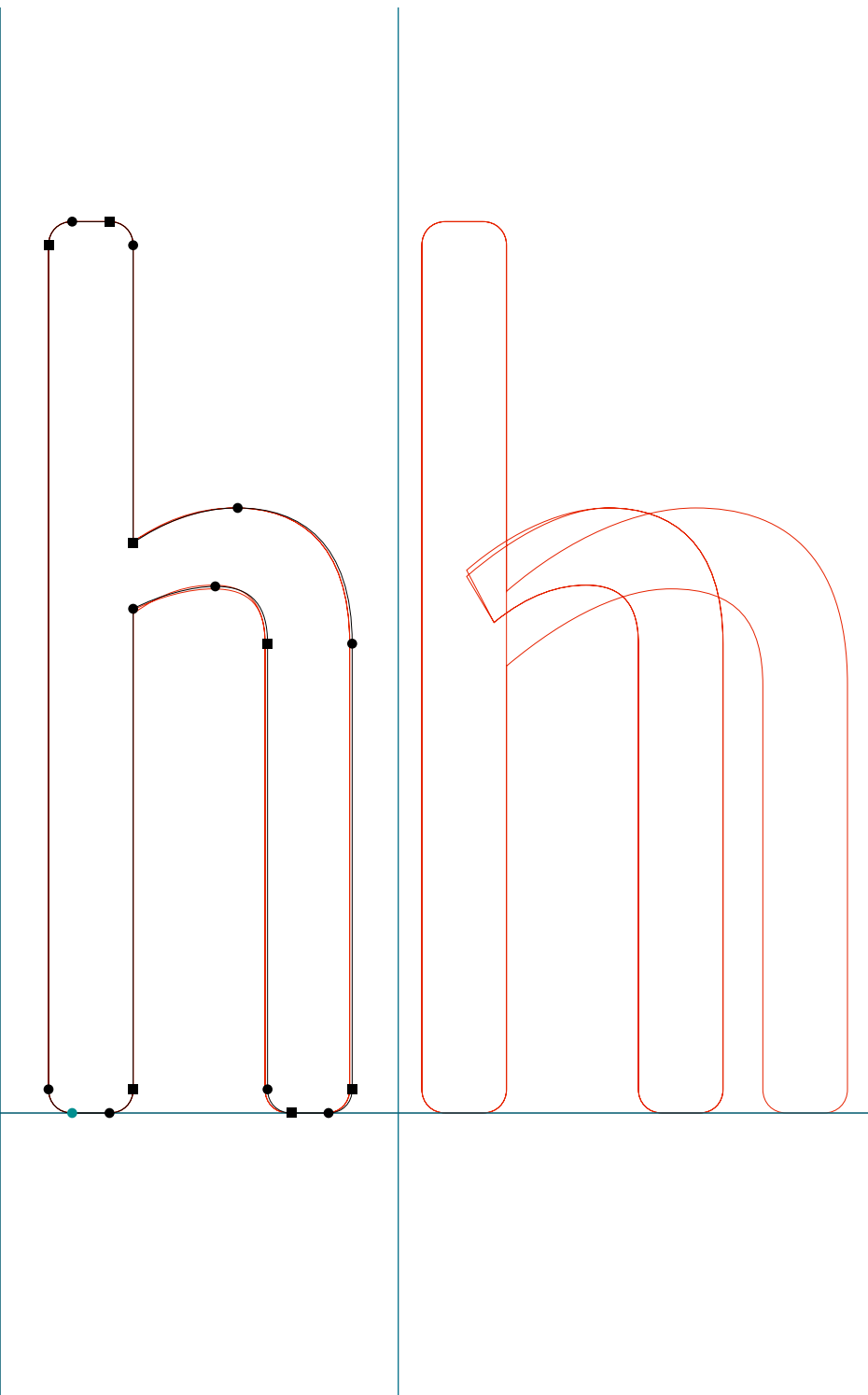

PROGRAM

.....
Program NarRegular | m | RoboFog Sketches | 2013 | Emigre Fonts

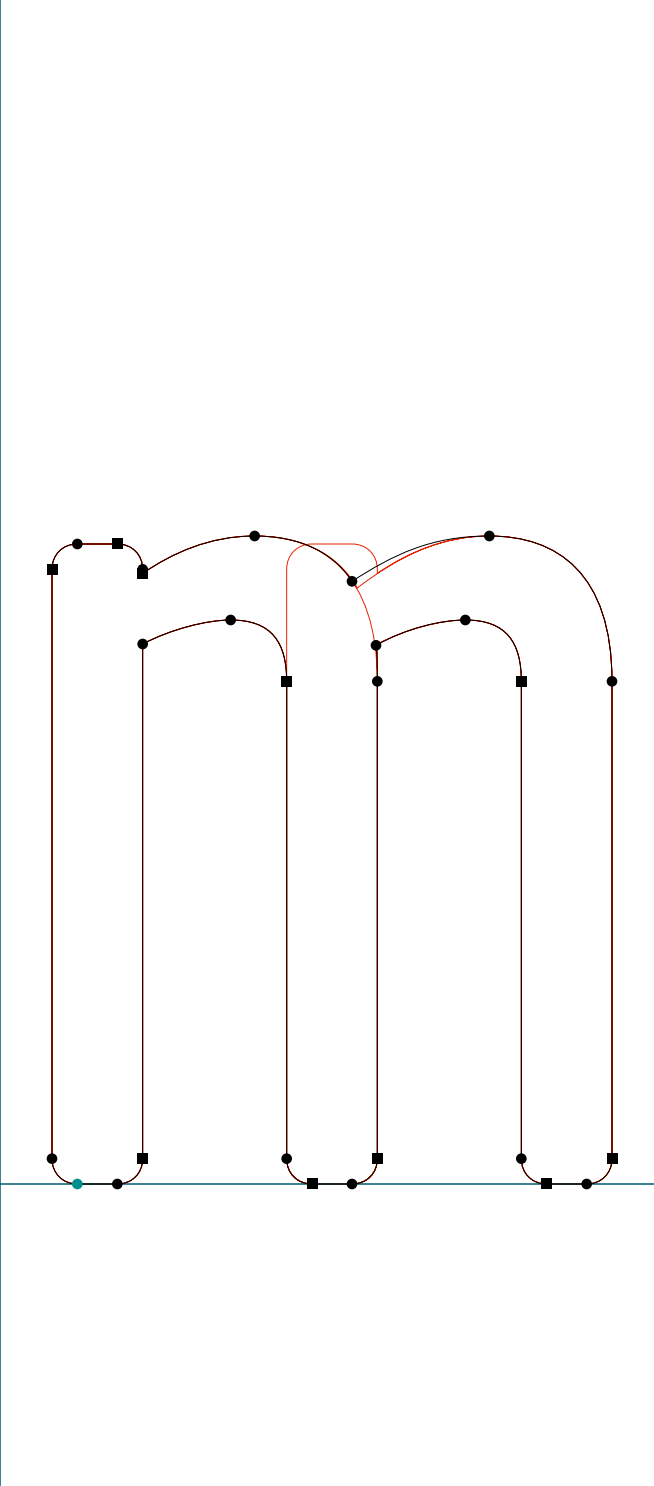

PROGRAM

.....
Program NarRegular | n | RoboFog Sketches | 2013 | Emigre Fonts

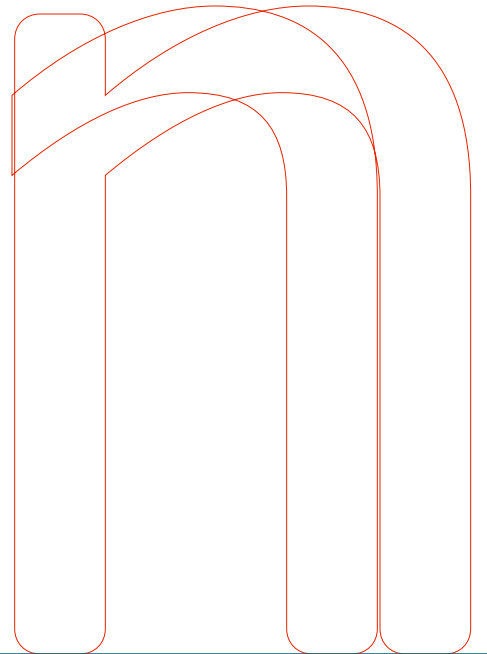
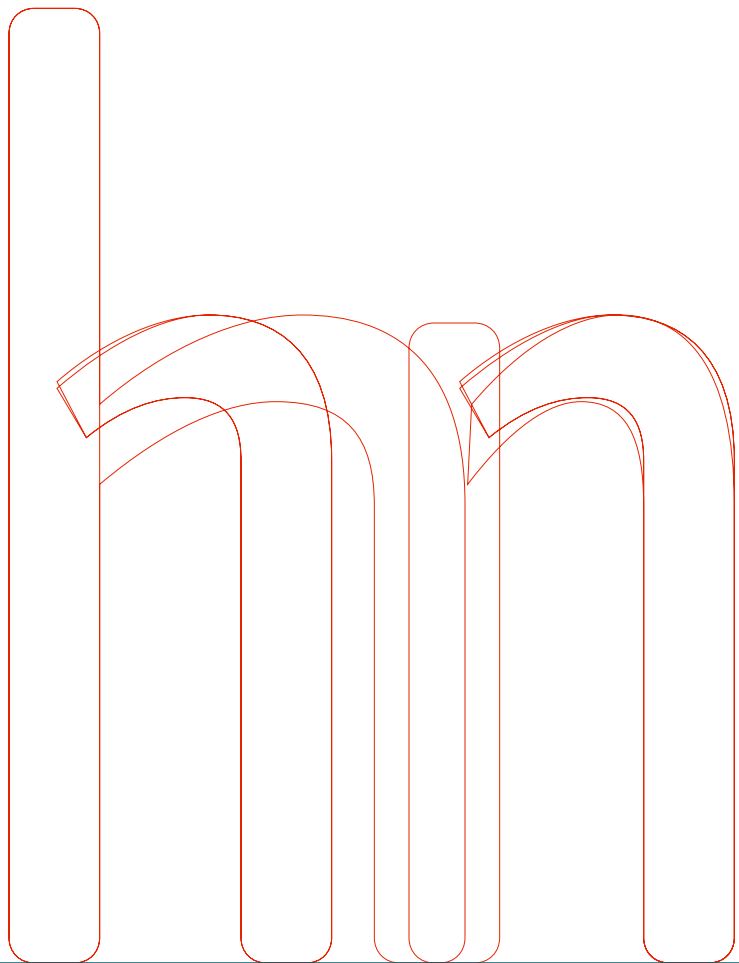
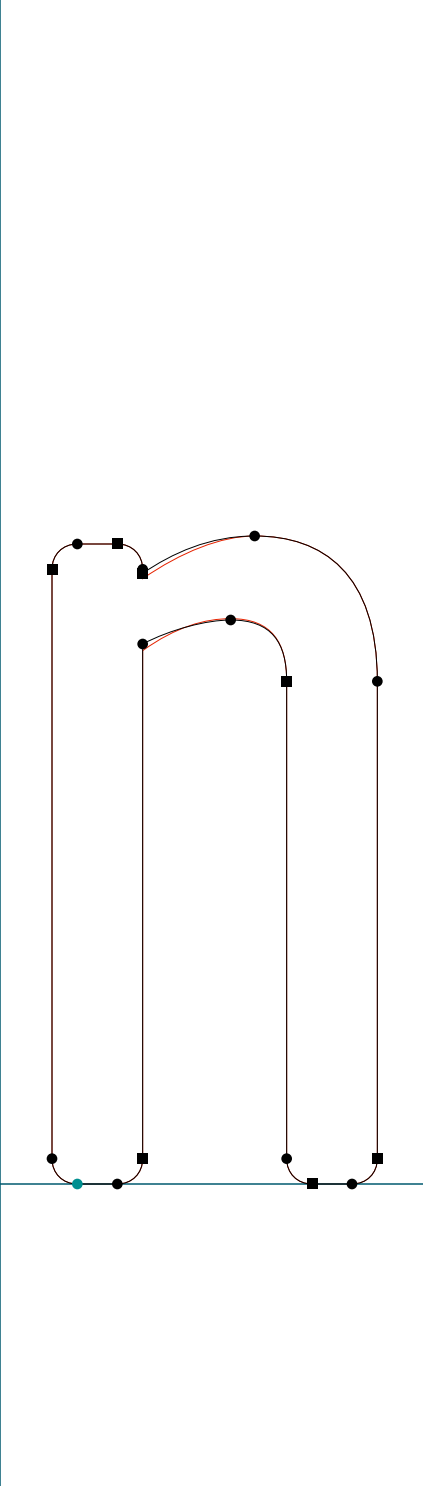

PROGRAM

.....
Program NarRegular | o | RoboFog Sketches | 2013 | Emigre Fonts

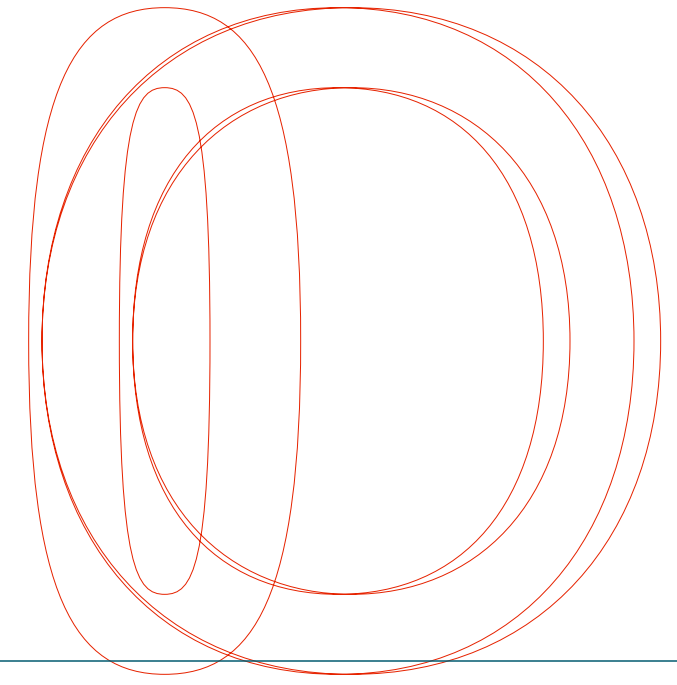
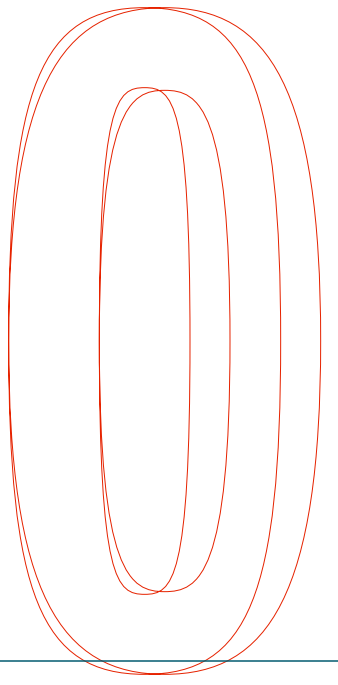
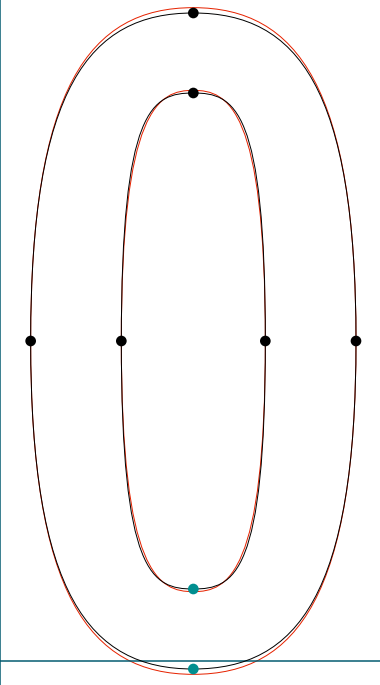

PROGRAM

.....
Program NarRegular | q | RoboFog Sketches | 2013 | Emigre Fonts

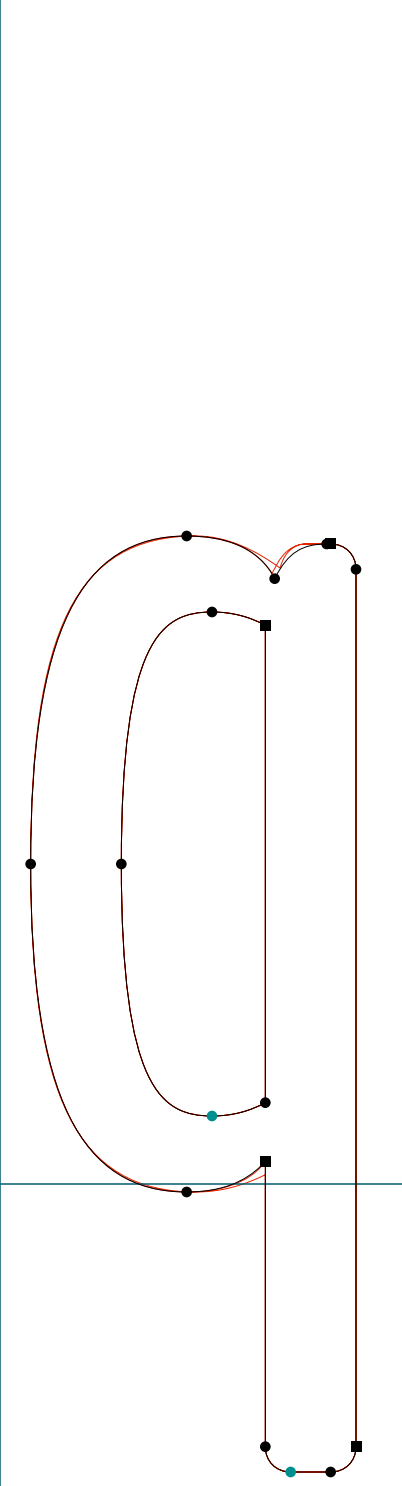

PROGRAM

.....
Program NarRegular | r | RoboFog Sketches | 2013 | Emigre Fonts

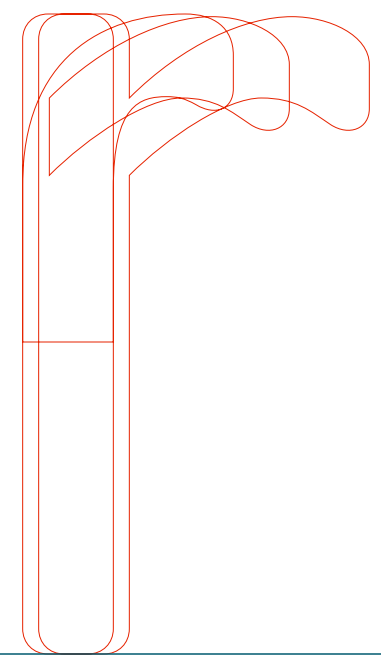
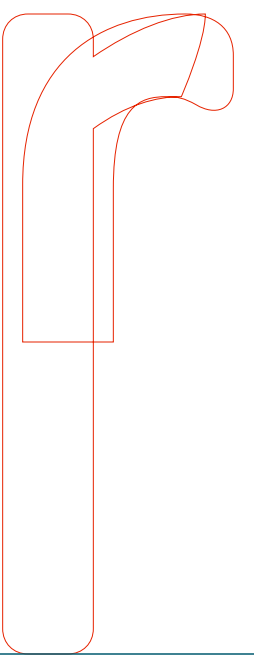
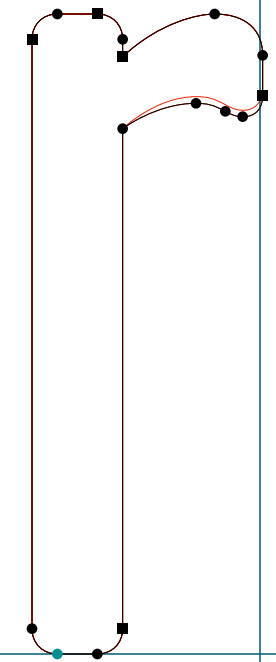
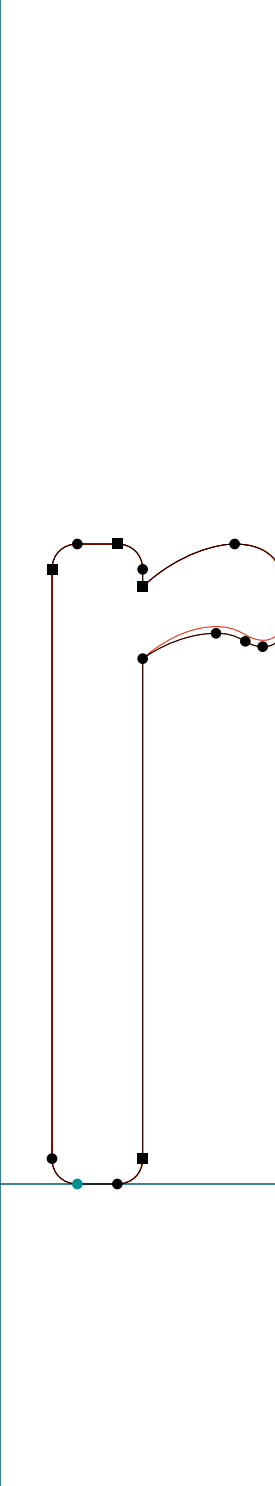

PROGRAM

.....
Program NarRegular | t | RoboFog Sketches | 2013 | Emigre Fonts

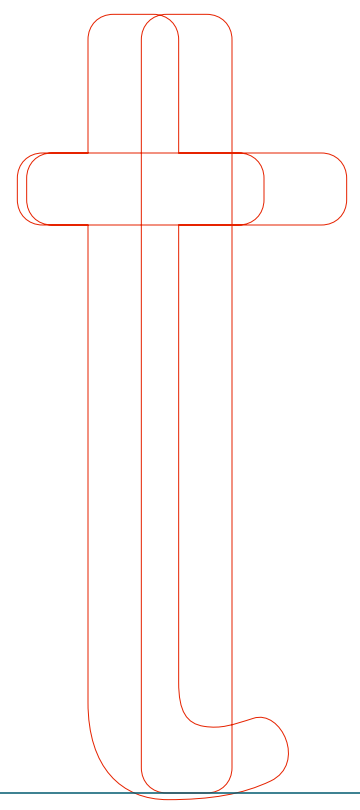
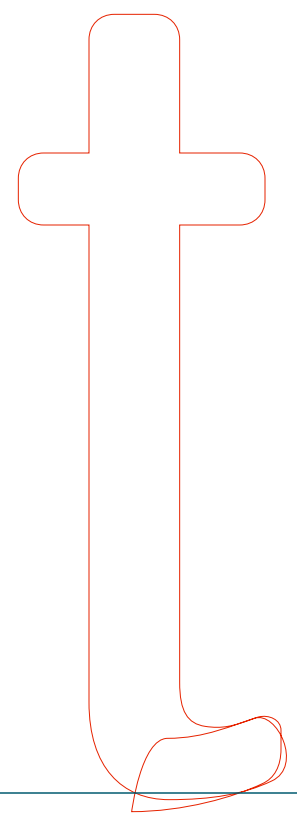
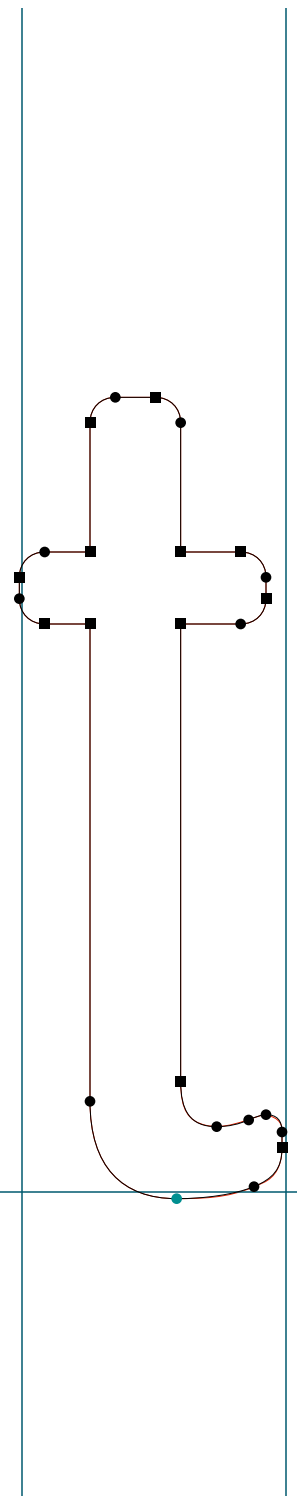

PROGRAM

.....
Program NarRegular | u | RoboFog Sketches | 2013 | Emigre Fonts

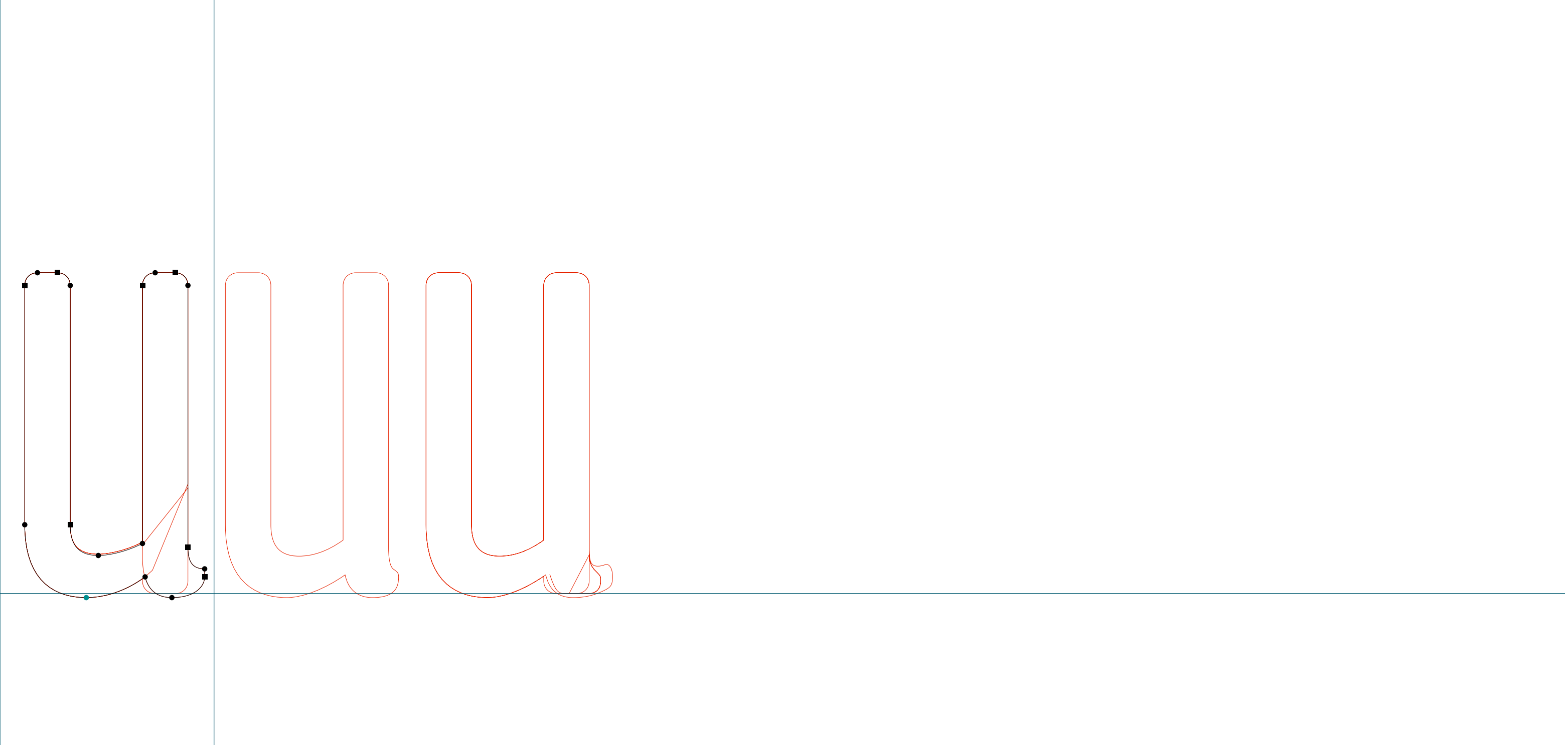

PROGRAM

.....
Program NarRegular | v | RoboFog Sketches | 2013 | Emigre Fonts



PROGRAM

Program NarRegular | w | RoboFog Sketches | 2013 | Emigre Fonts



PROGRAM

.....
Program NarRegular | y | RoboFog Sketches | 2013 | Emigre Fonts

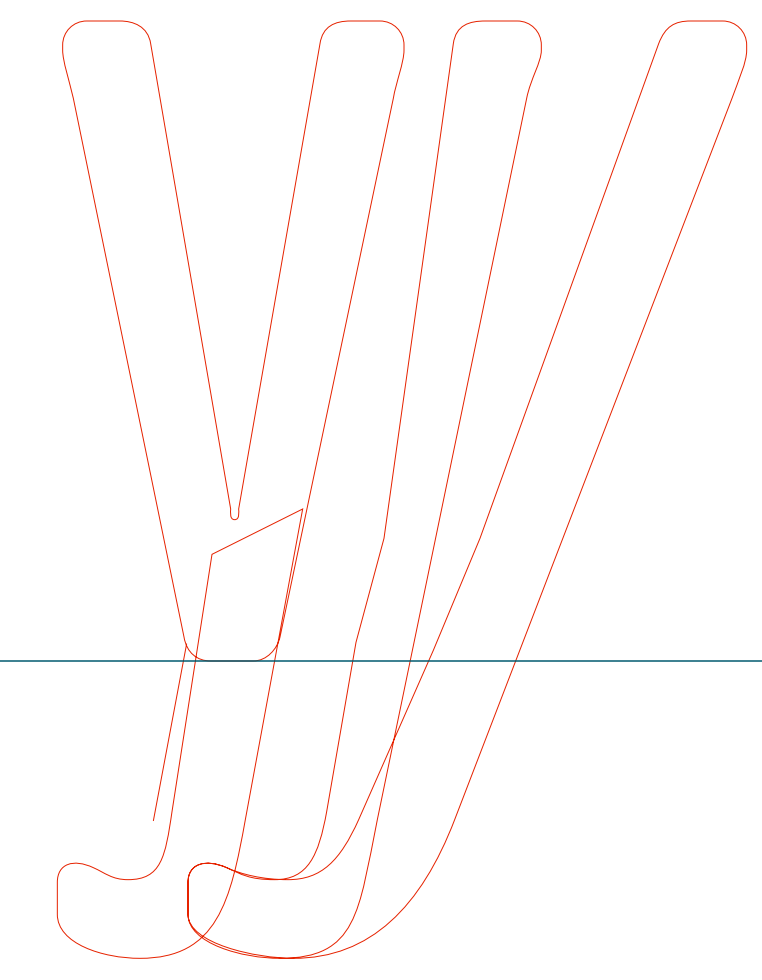
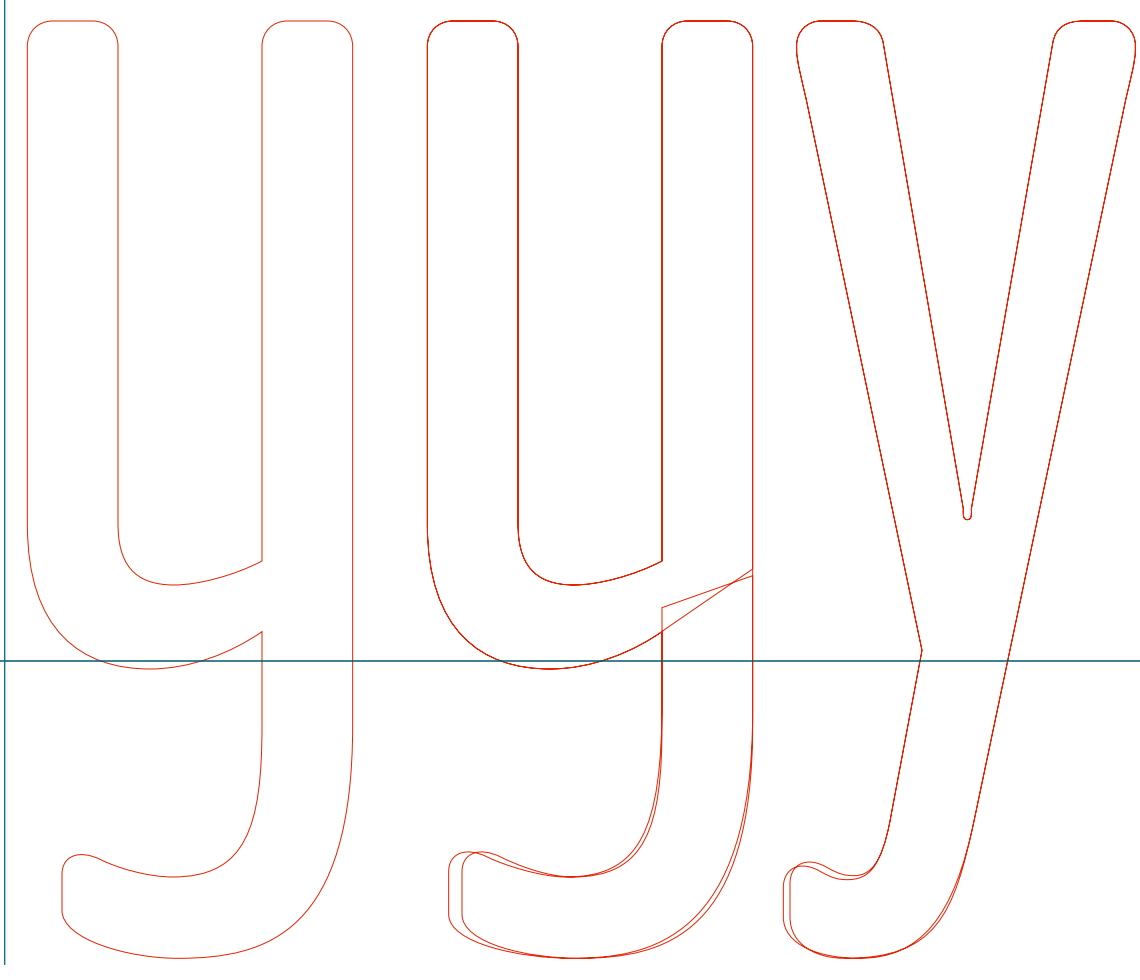
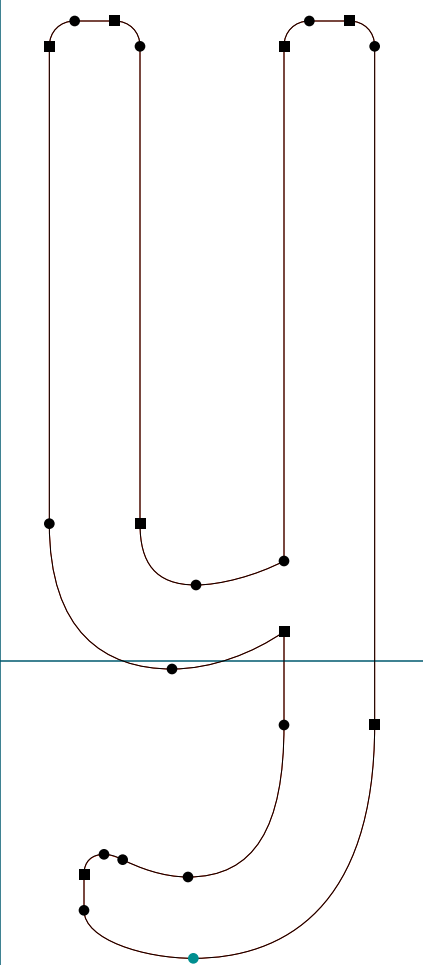

PROGRAM

Program NarRegular | asciitilde | RoboFog Sketches | 2013 | Emigre Fonts

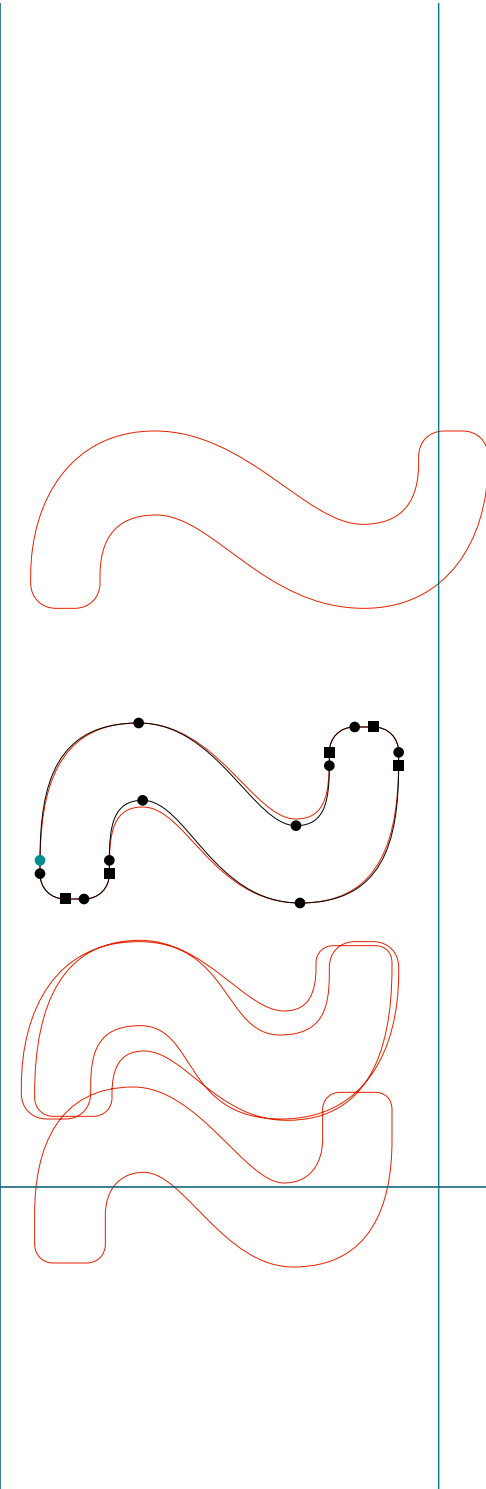

PROGRAM

Program NarRegular | cent | RoboFog Sketches | 2013 | Emigre Fonts

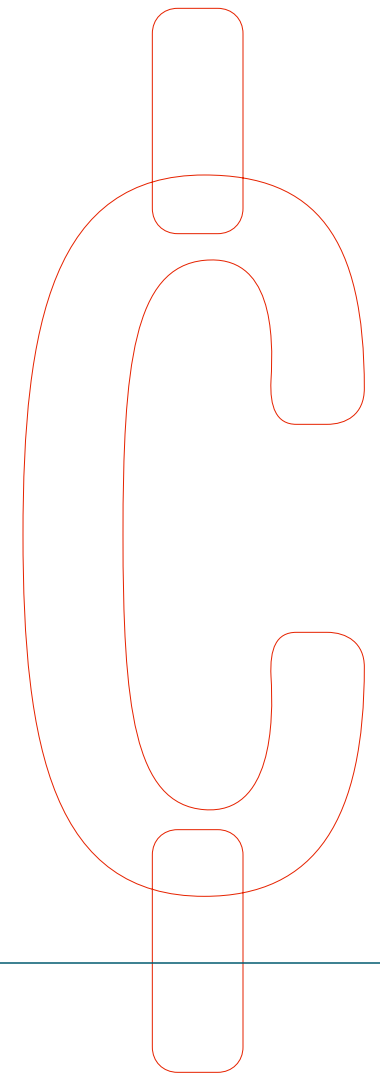
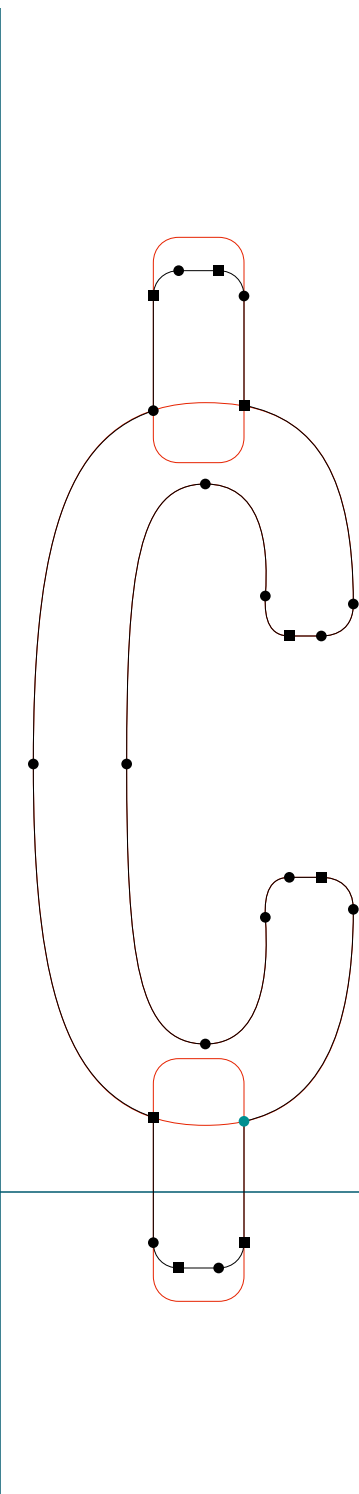

PROGRAM

.....
Program NarRegular | apple | RoboFog Sketches | 2013 | Emigre Fonts

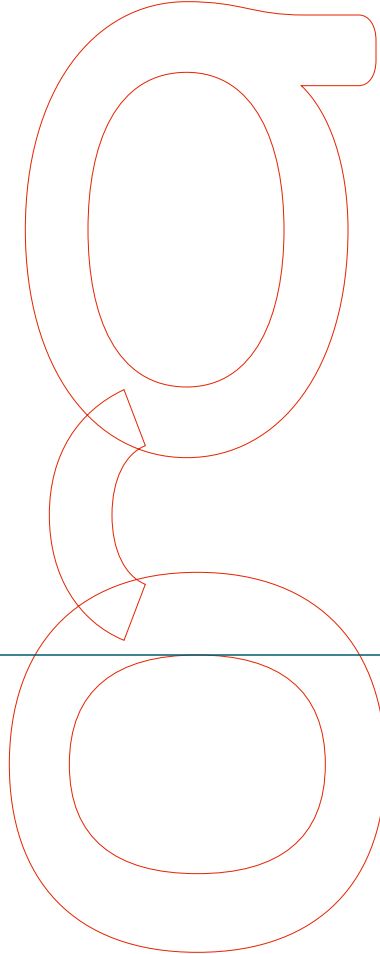

PROGRAM

.....
Program NarMedium | two | RoboFog Sketches | 2013 | Emigre Fonts

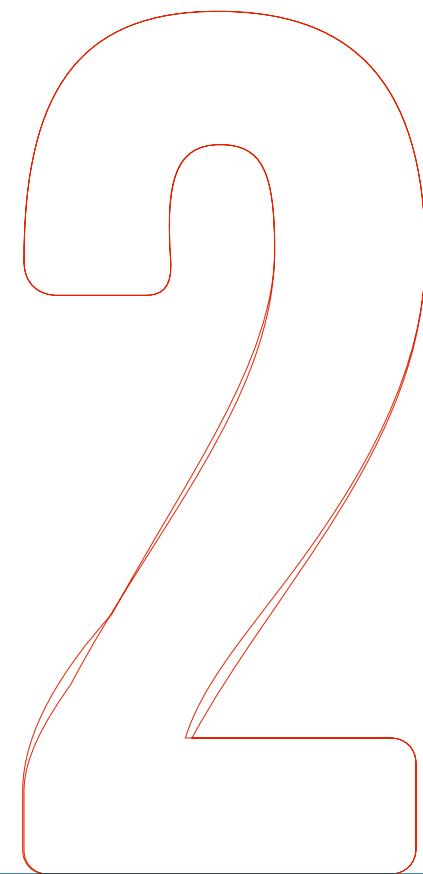
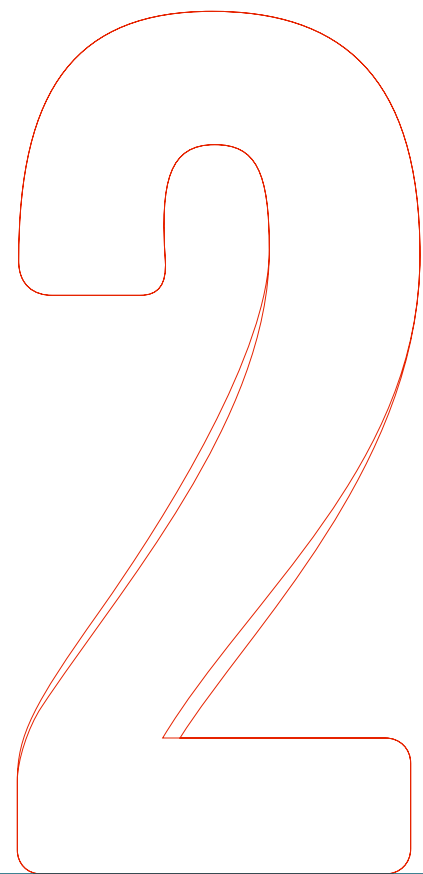
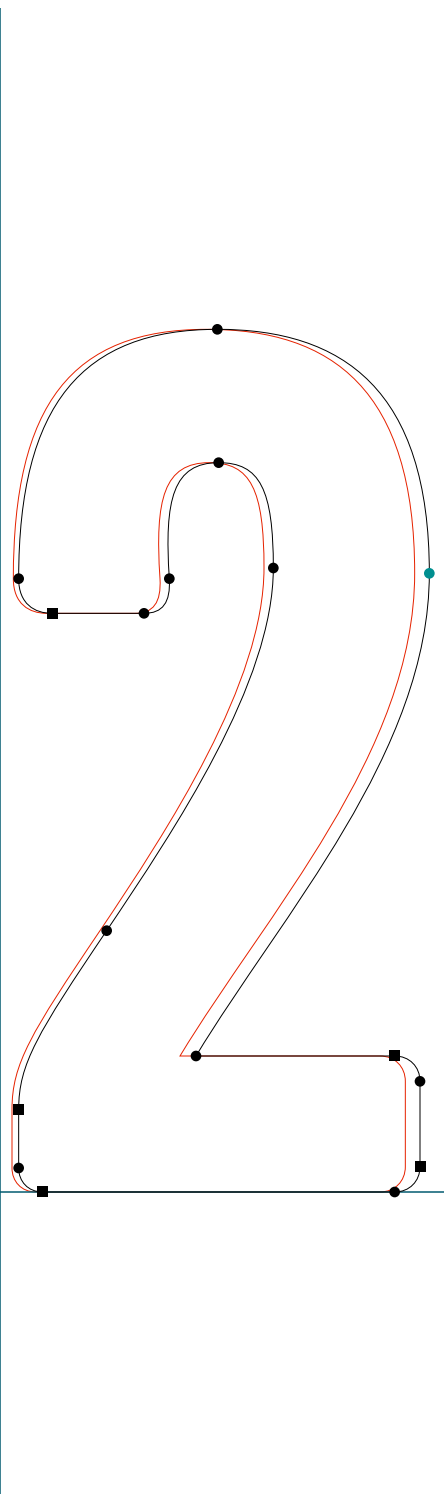

PROGRAM

.....
Program NarMedium | sterling | RoboFog Sketches | 2013 | Emigre Fonts

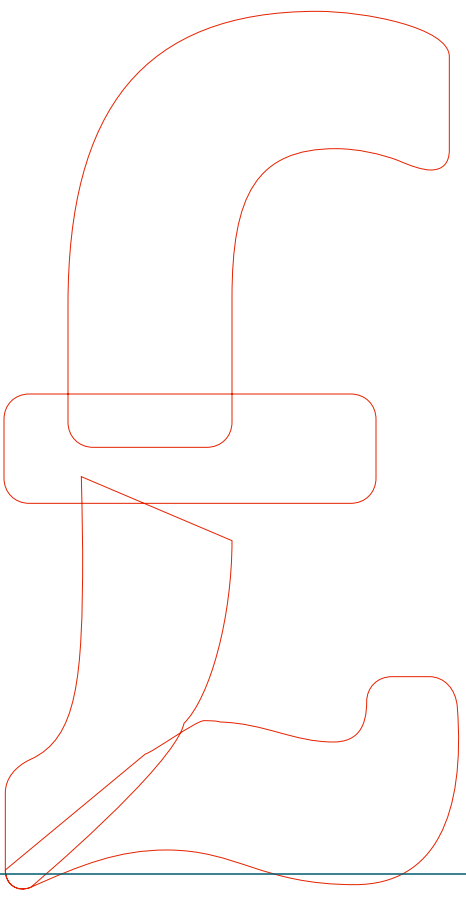
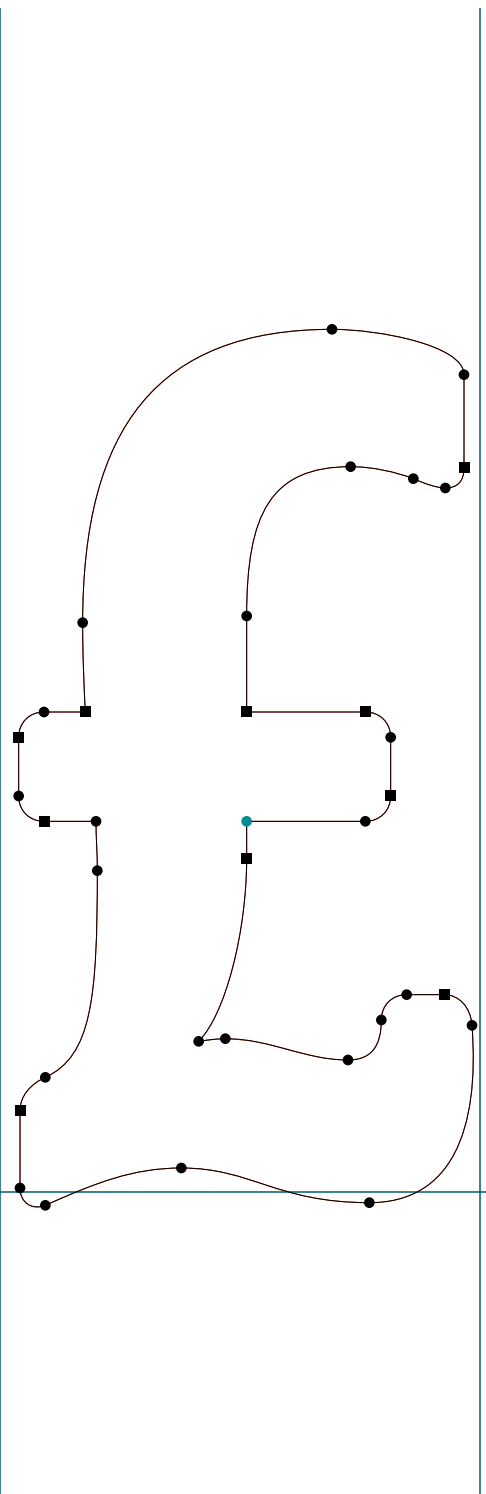

PROGRAM

.....
Program NarMedium | apple | RoboFog Sketches | 2013 | Emigre Fonts

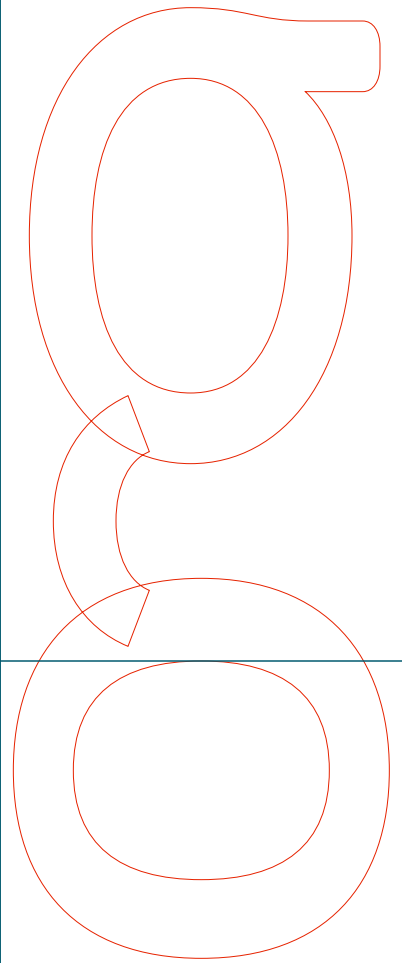

PROGRAM

.....
Program NarBlack | asterisk | RoboFog Sketches | 2013 | Emigre Fonts

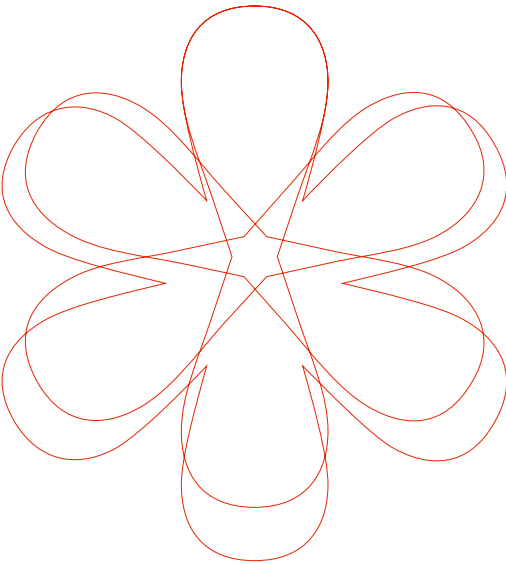
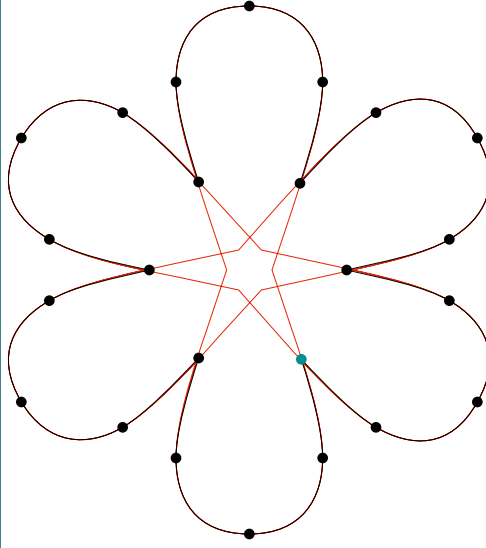
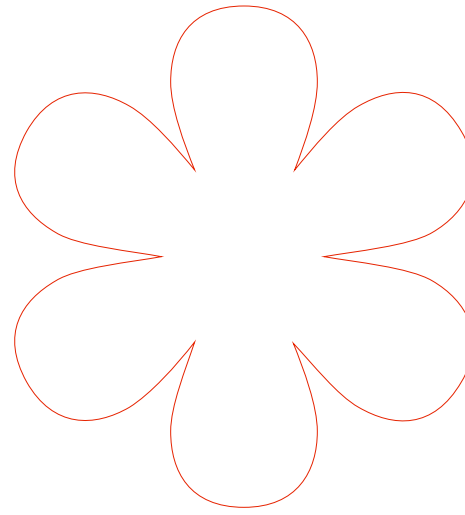

PROGRAM

.....
Program NarBlack | two | RoboFog Sketches | 2013 | Emigre Fonts

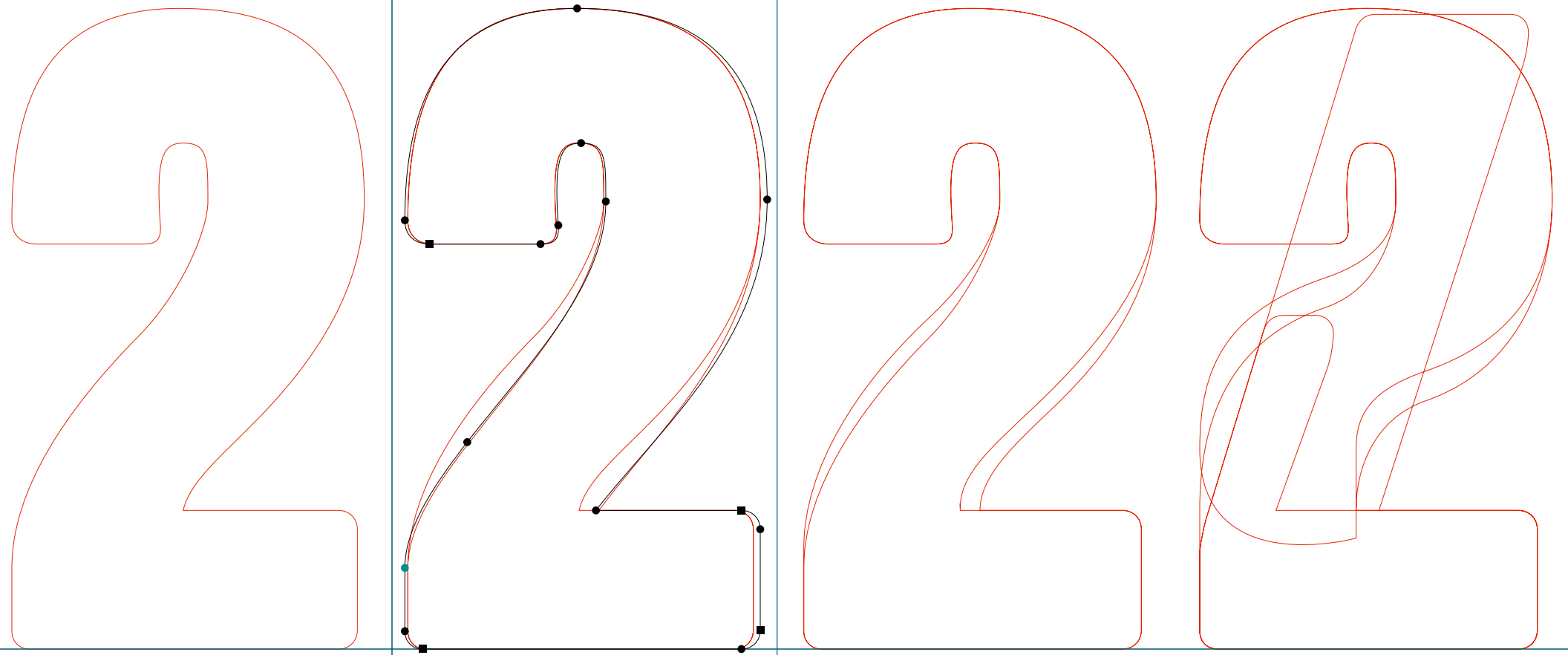

PROGRAM

.....
Program NarBlack | three | RoboFog Sketches | 2013 | Emigre Fonts

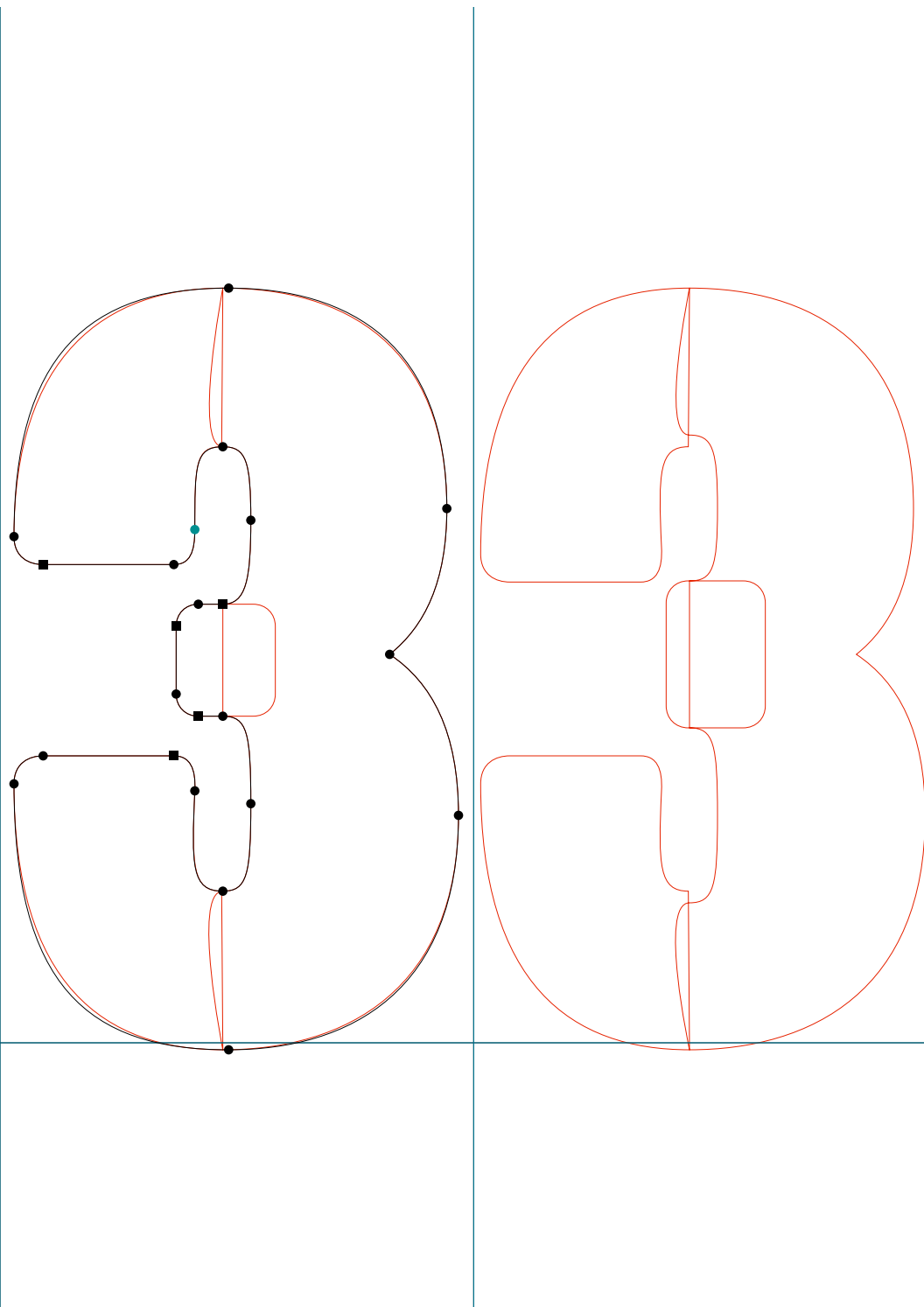

PROGRAM

.....
Program NarBlack | five | RoboFog Sketches | 2013 | Emigre Fonts

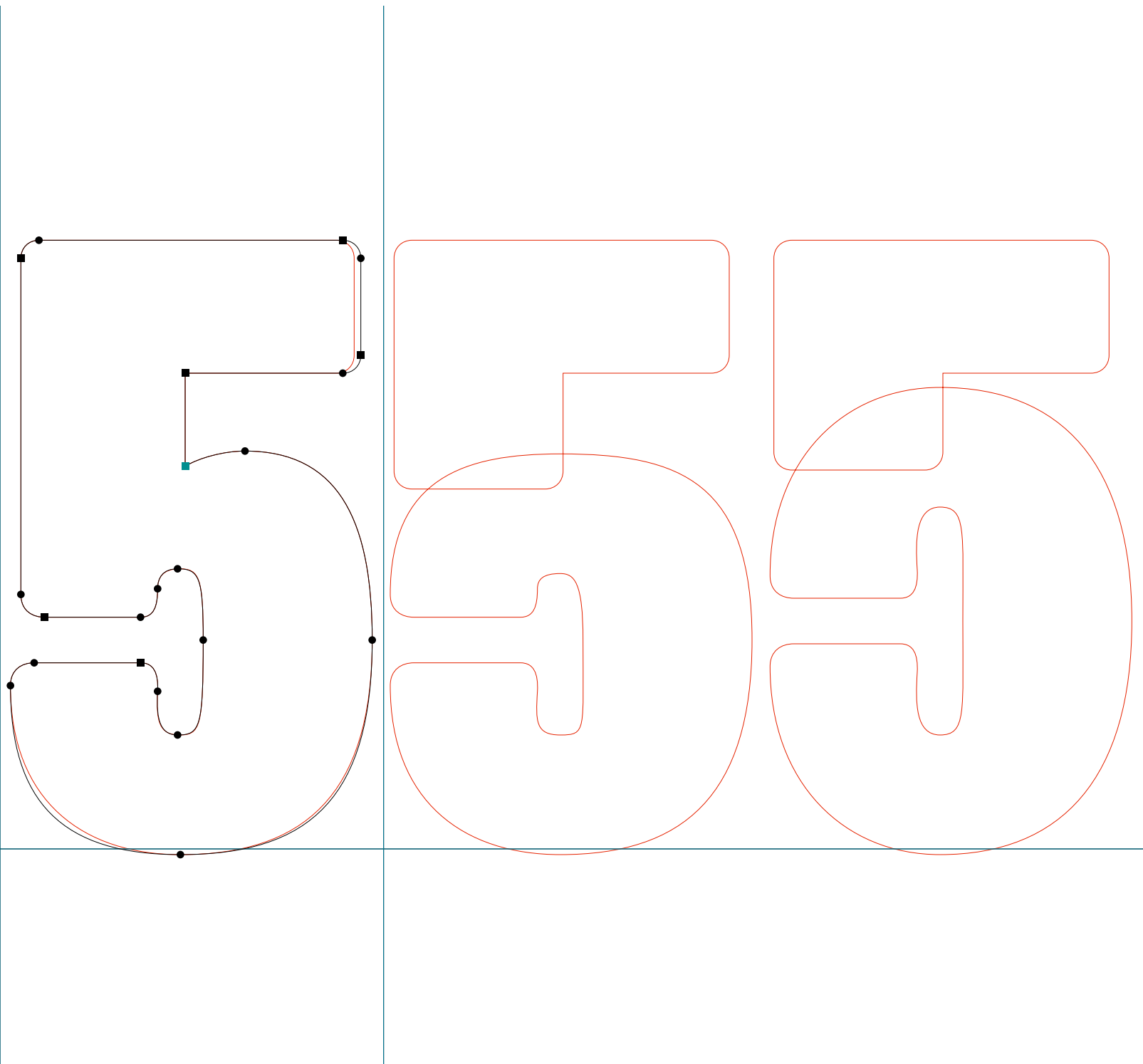

PROGRAM

.....
Program NarBlack | six | RoboFog Sketches | 2013 | Emigre Fonts

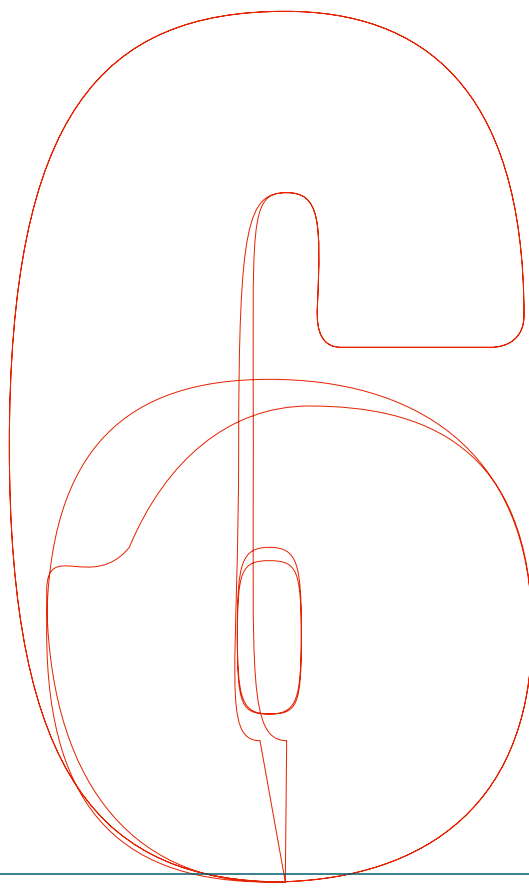
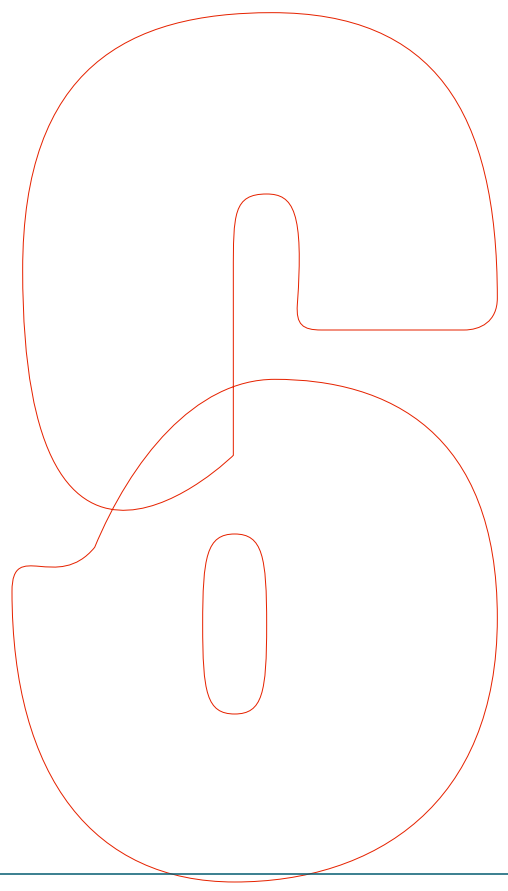
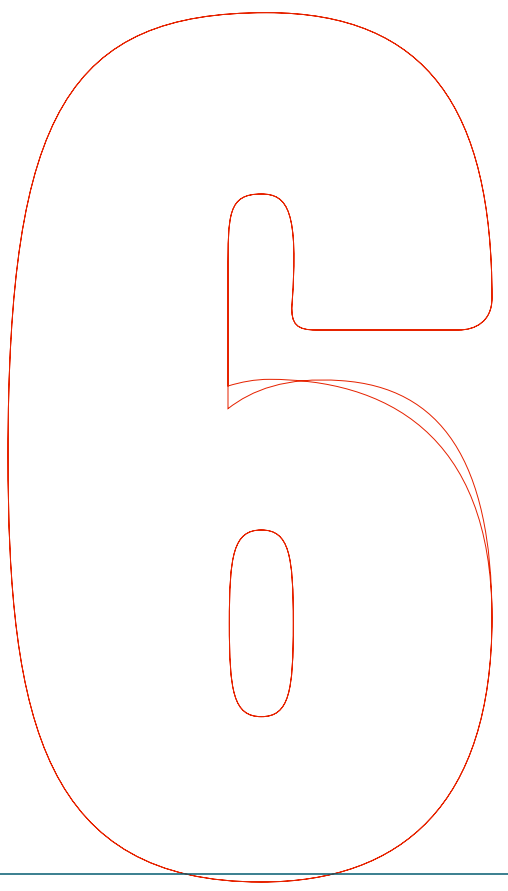
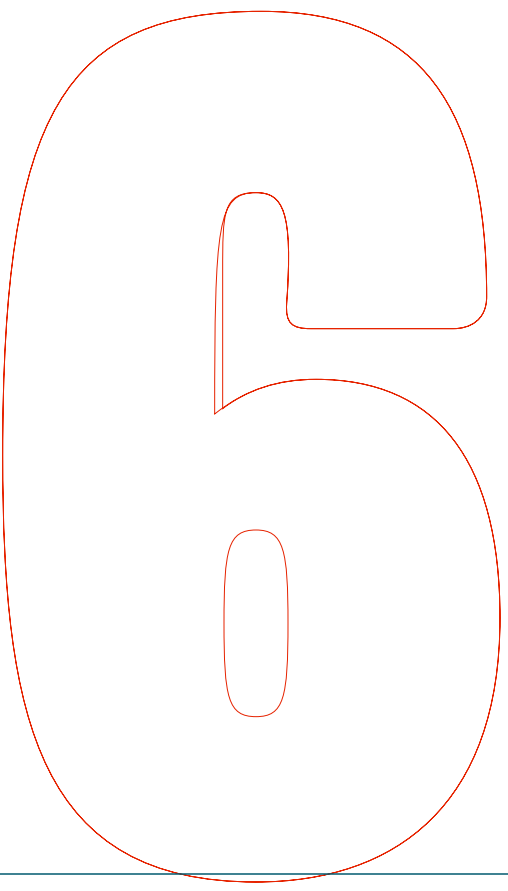
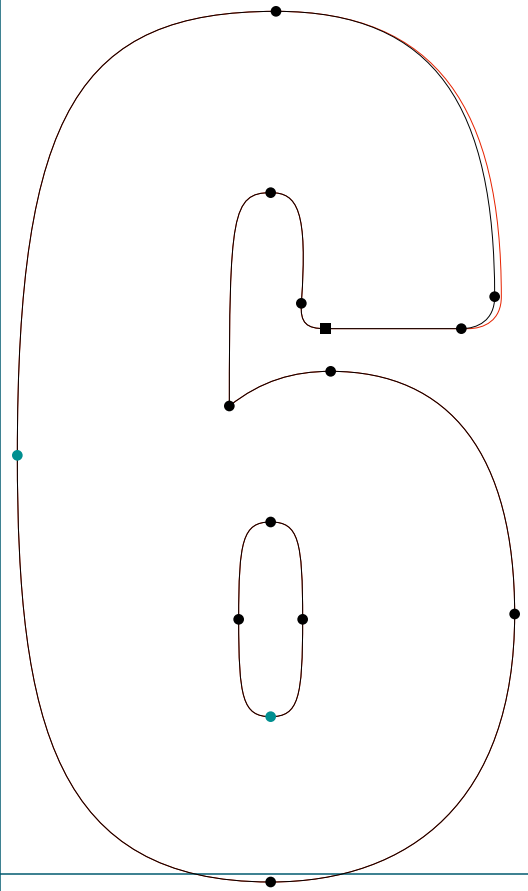

PROGRAM

.....
Program NarBlack | question | RoboFog Sketches | 2013 | Emigre Fonts

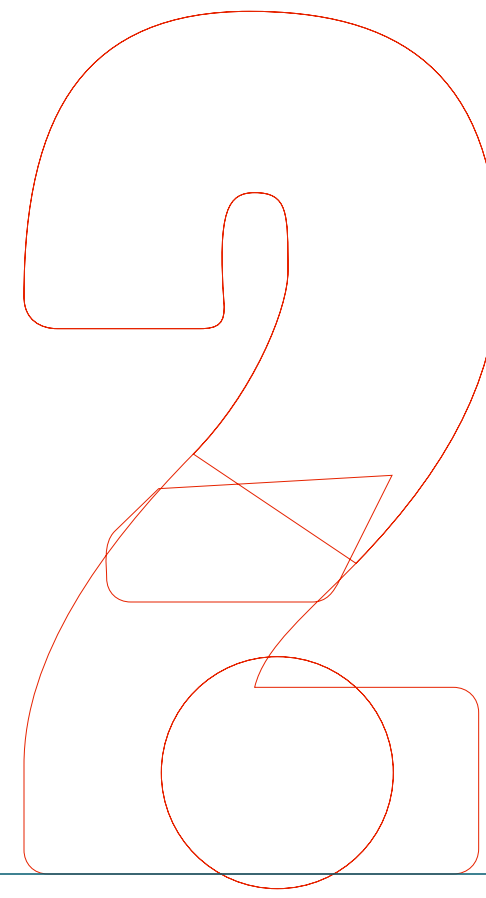
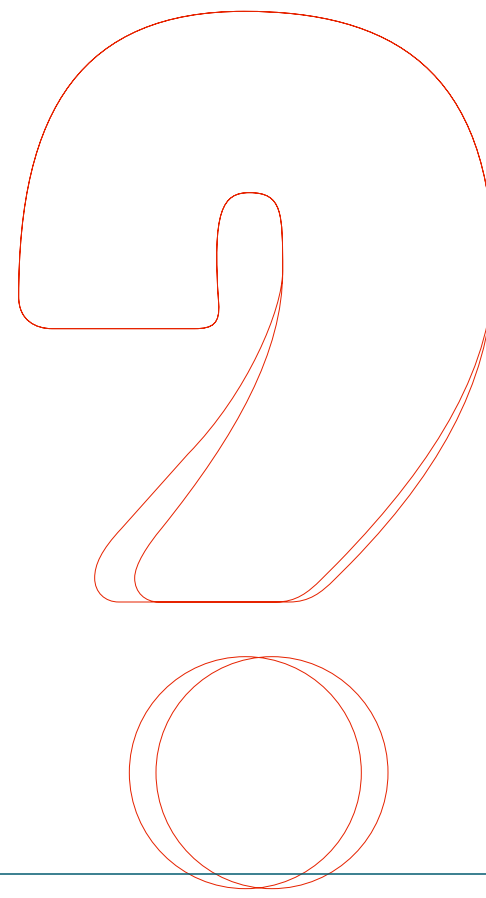
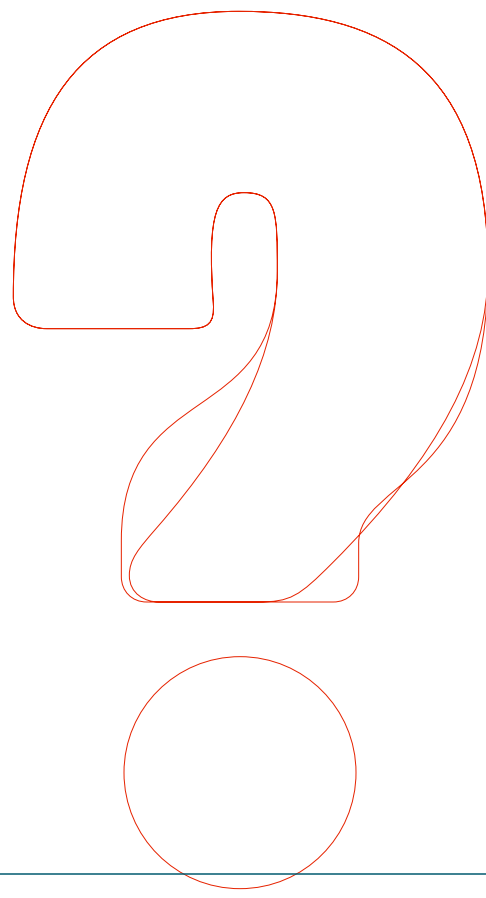
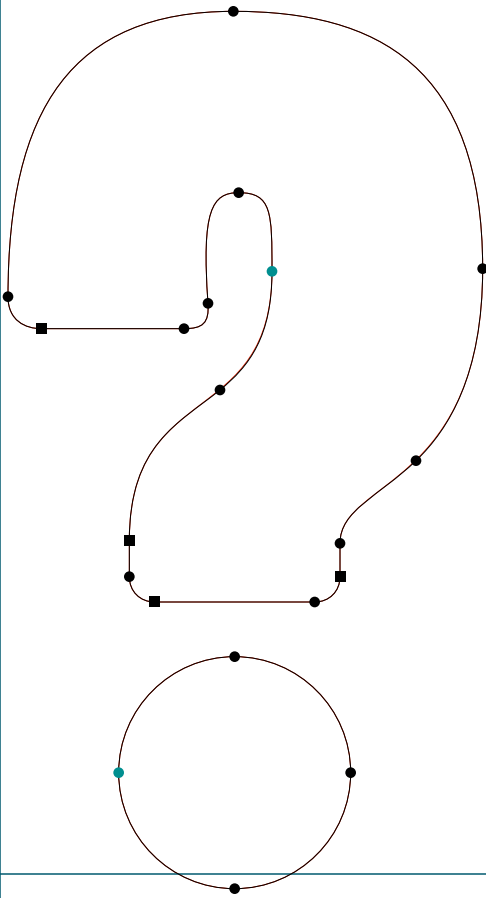

PROGRAM

.....
Program NarBlack | A | RoboFog Sketches | 2013 | Emigre Fonts

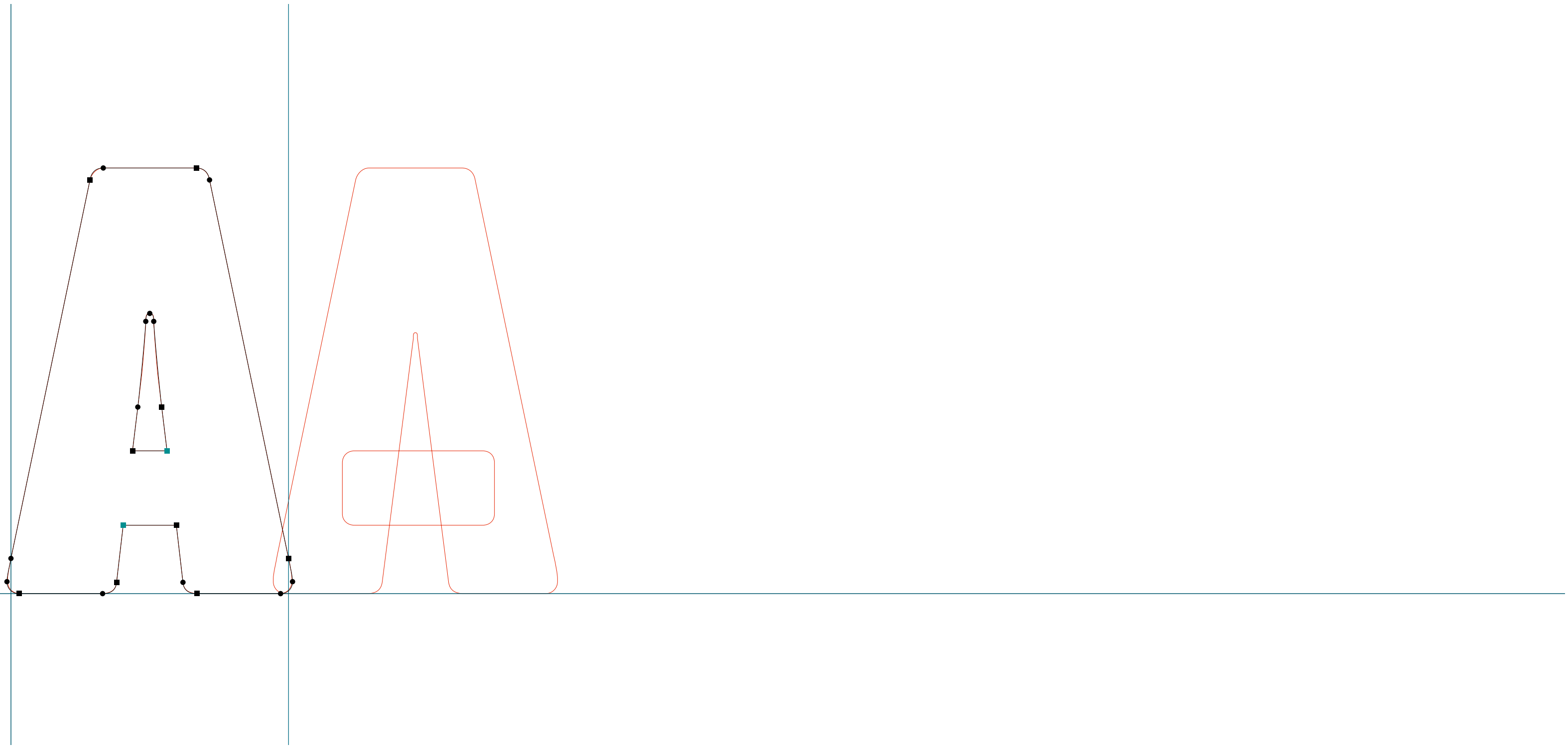

PROGRAM

.....
Program NarBlack | B | RoboFog Sketches | 2013 | Emigre Fonts

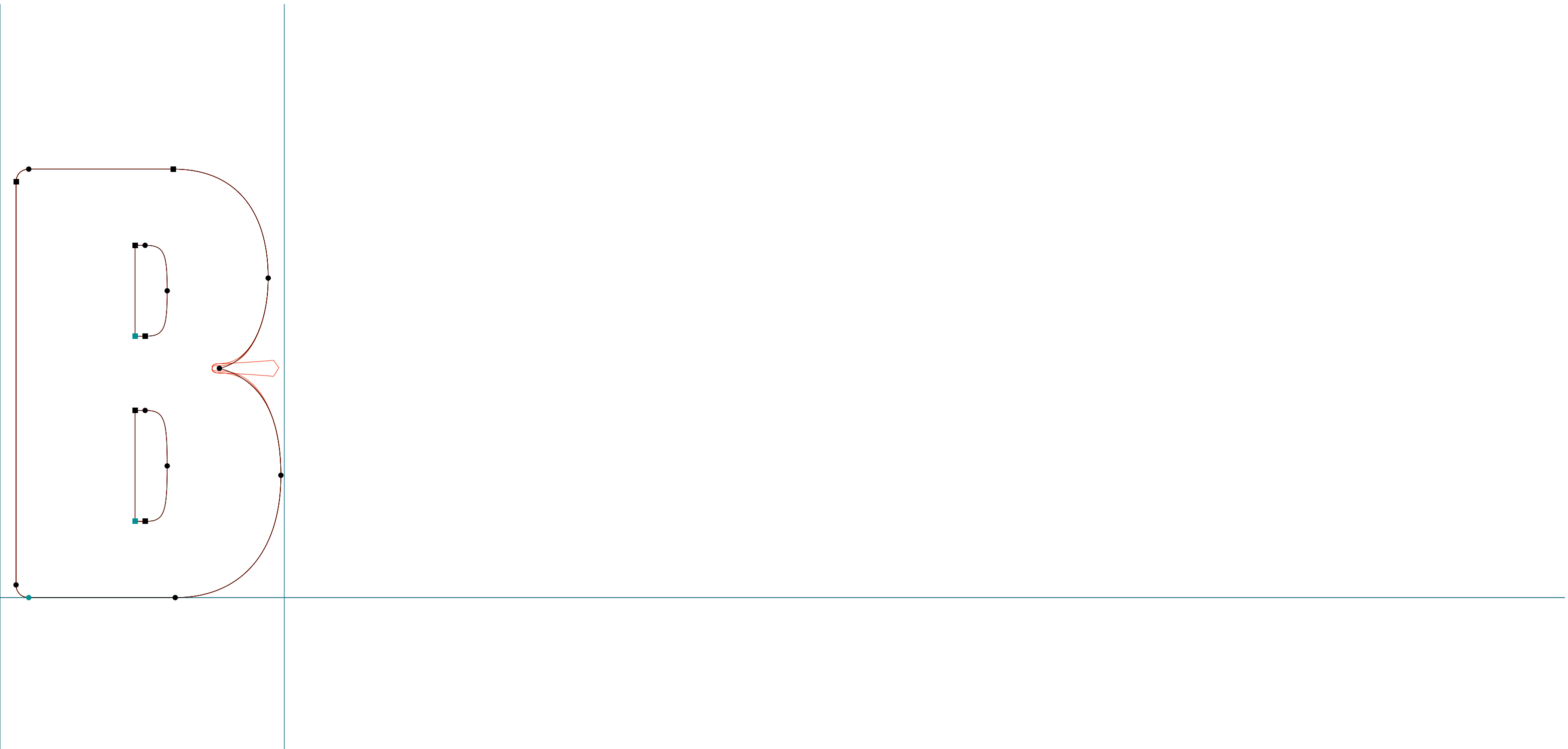

PROGRAM

.....
Program NarBlack | D | RoboFog Sketches | 2013 | Emigre Fonts

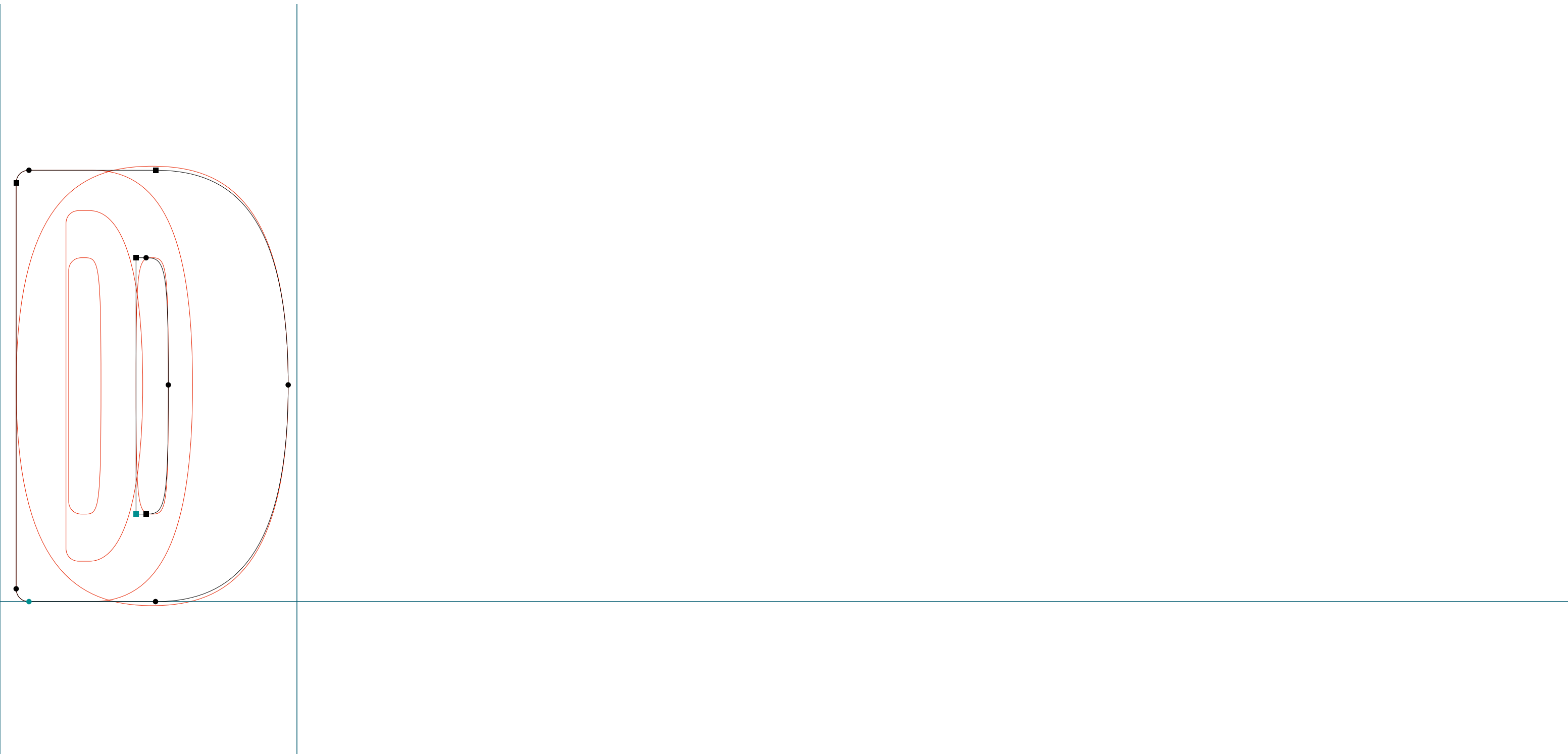

PROGRAM

.....
Program NarBlack | K | RoboFog Sketches | 2013 | Emigre Fonts

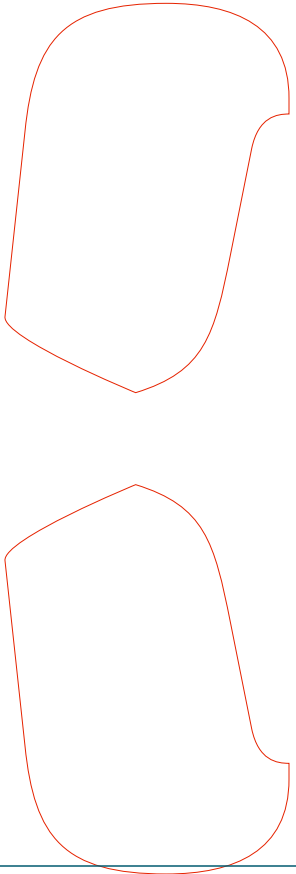
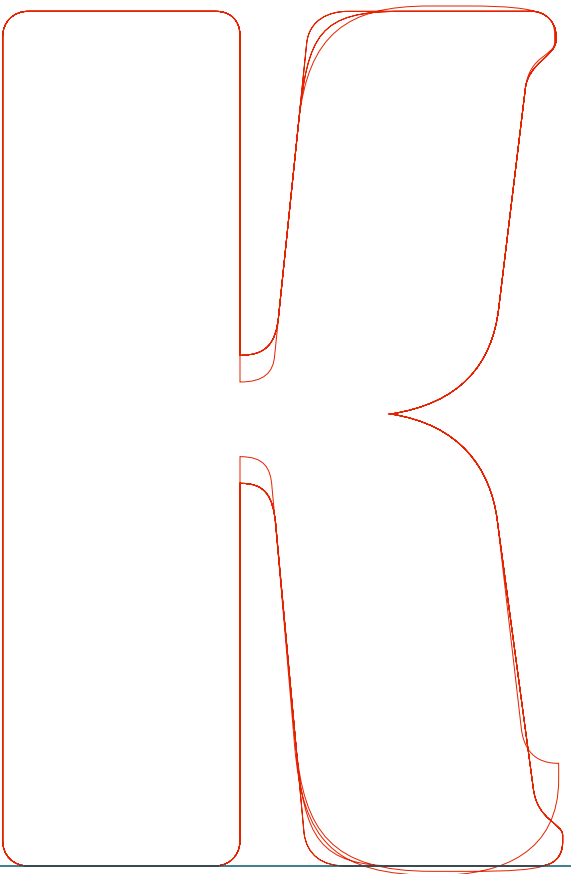
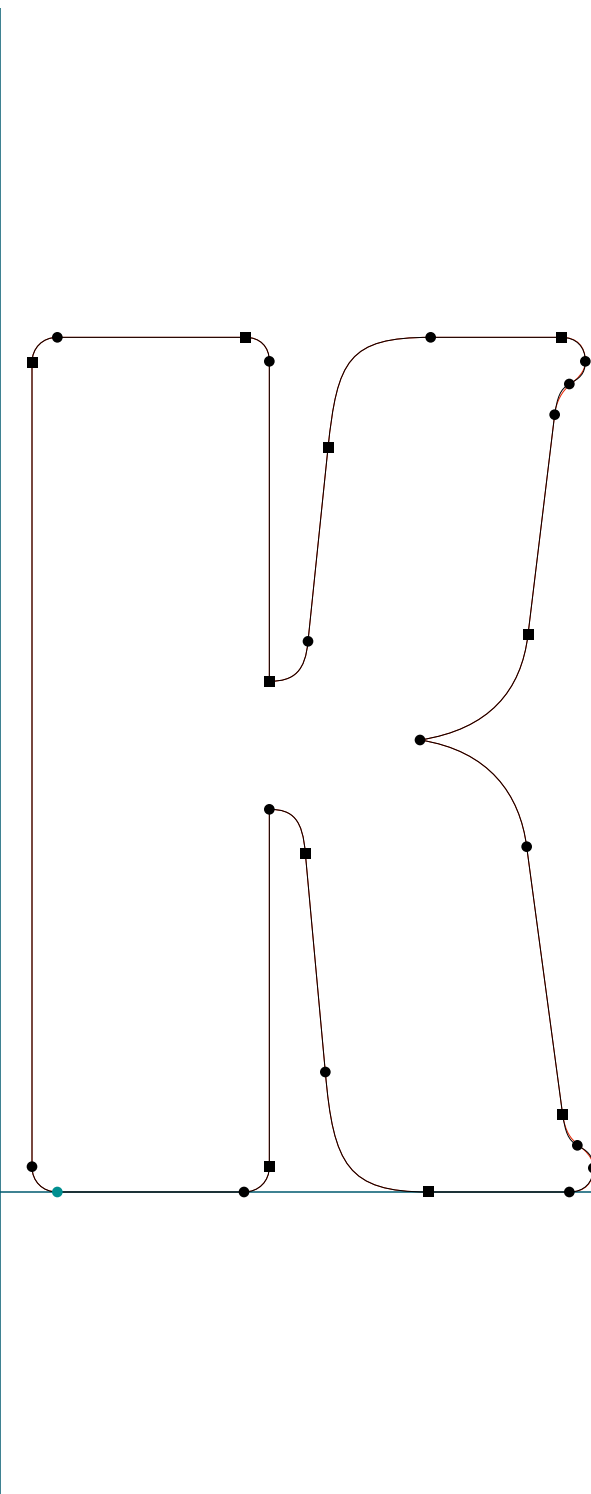

PROGRAM

.....
Program NarBlack | M | RoboFog Sketches | 2013 | Emigre Fonts



PROGRAM

Program NarBlack | N | RoboFog Sketches | 2013 | Emigre Fonts

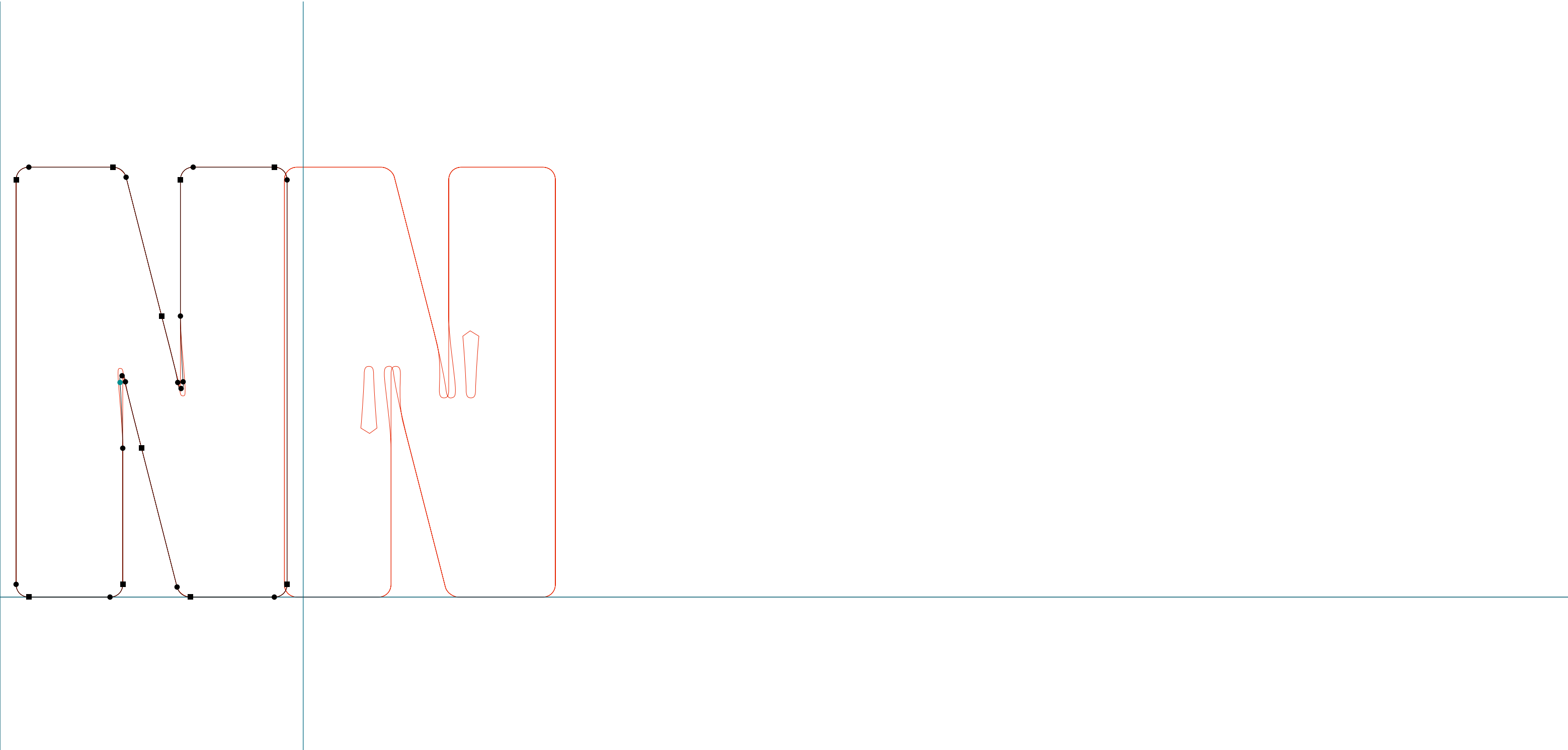

PROGRAM

.....
Program NarBlack | Q | RoboFog Sketches | 2013 | Emigre Fonts

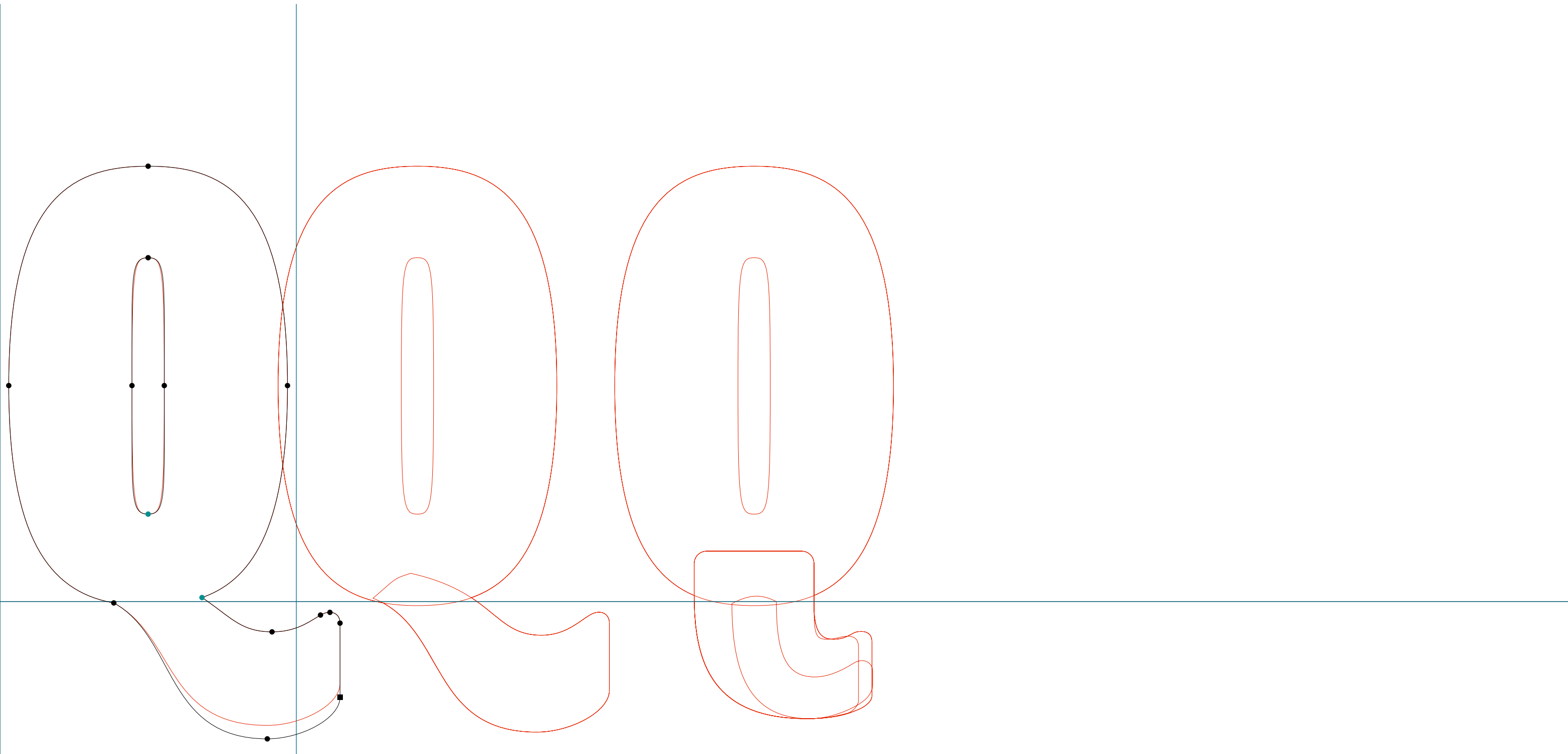

PROGRAM

.....
Program NarBlack | R | RoboFog Sketches | 2013 | Emigre Fonts

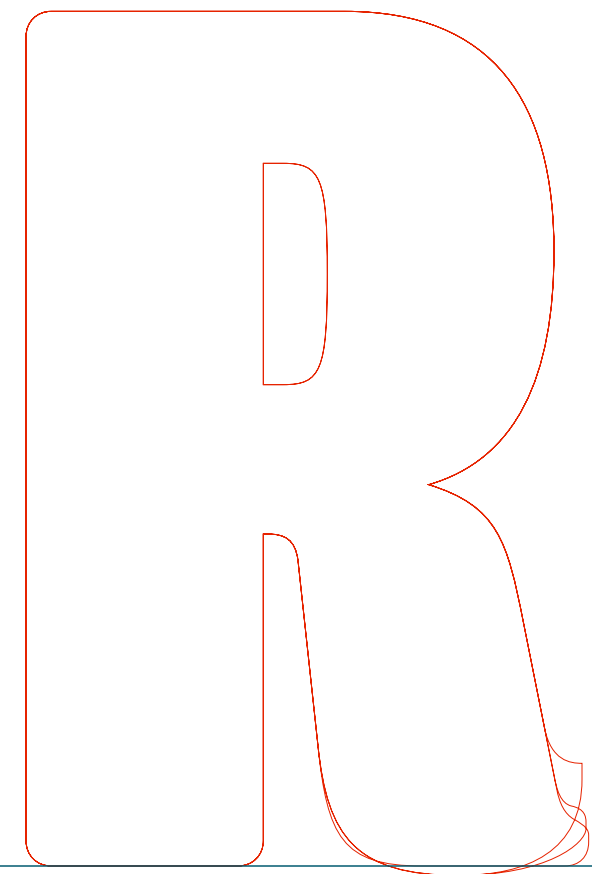
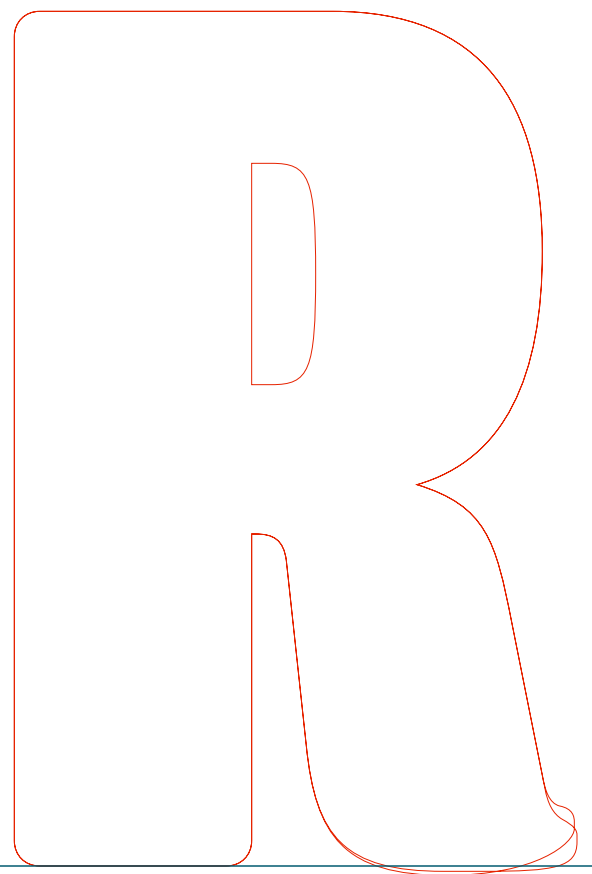
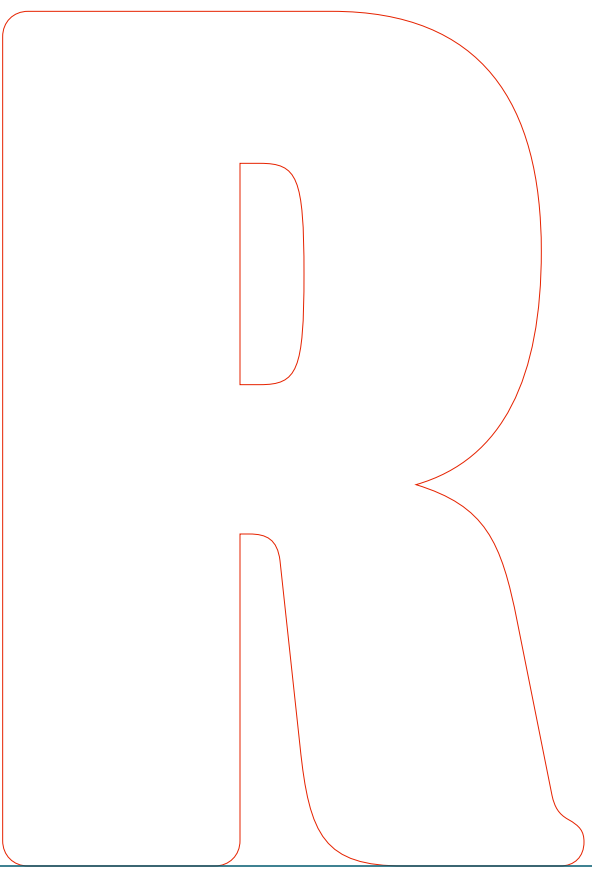
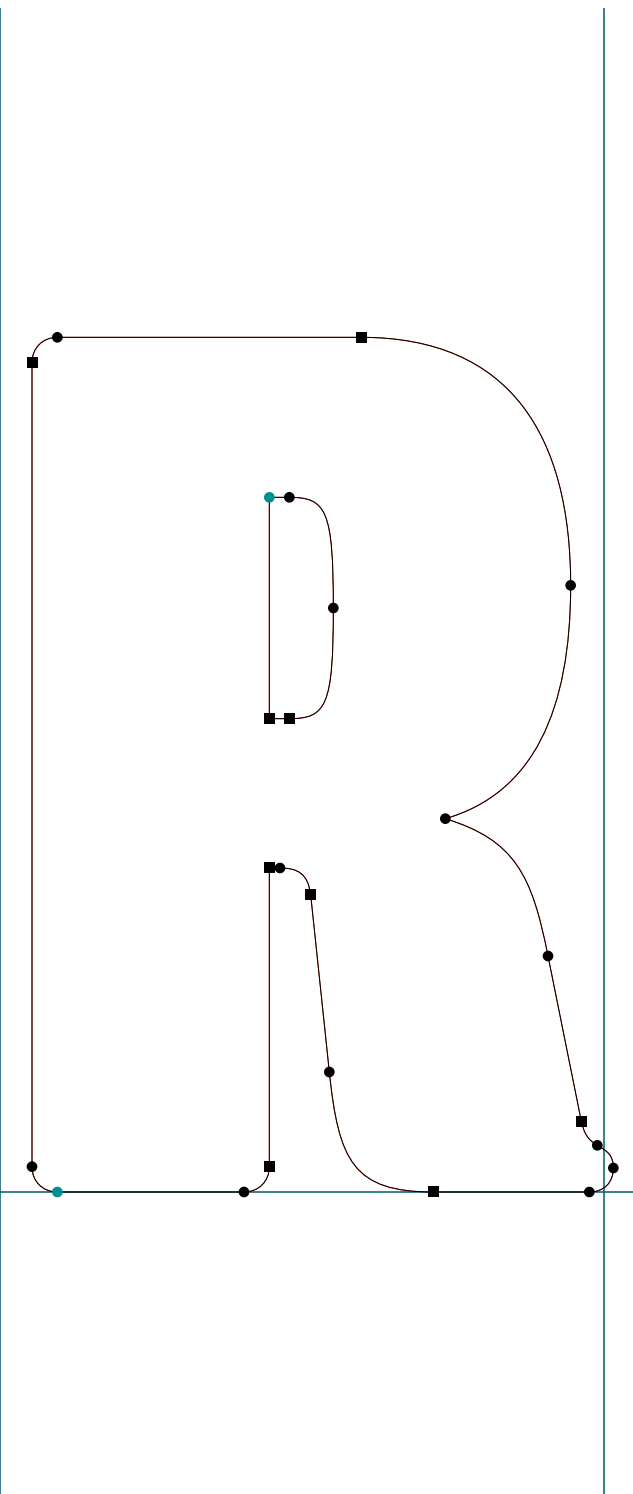

PROGRAM

.....
Program NarBlack | S | RoboFog Sketches | 2013 | Emigre Fonts

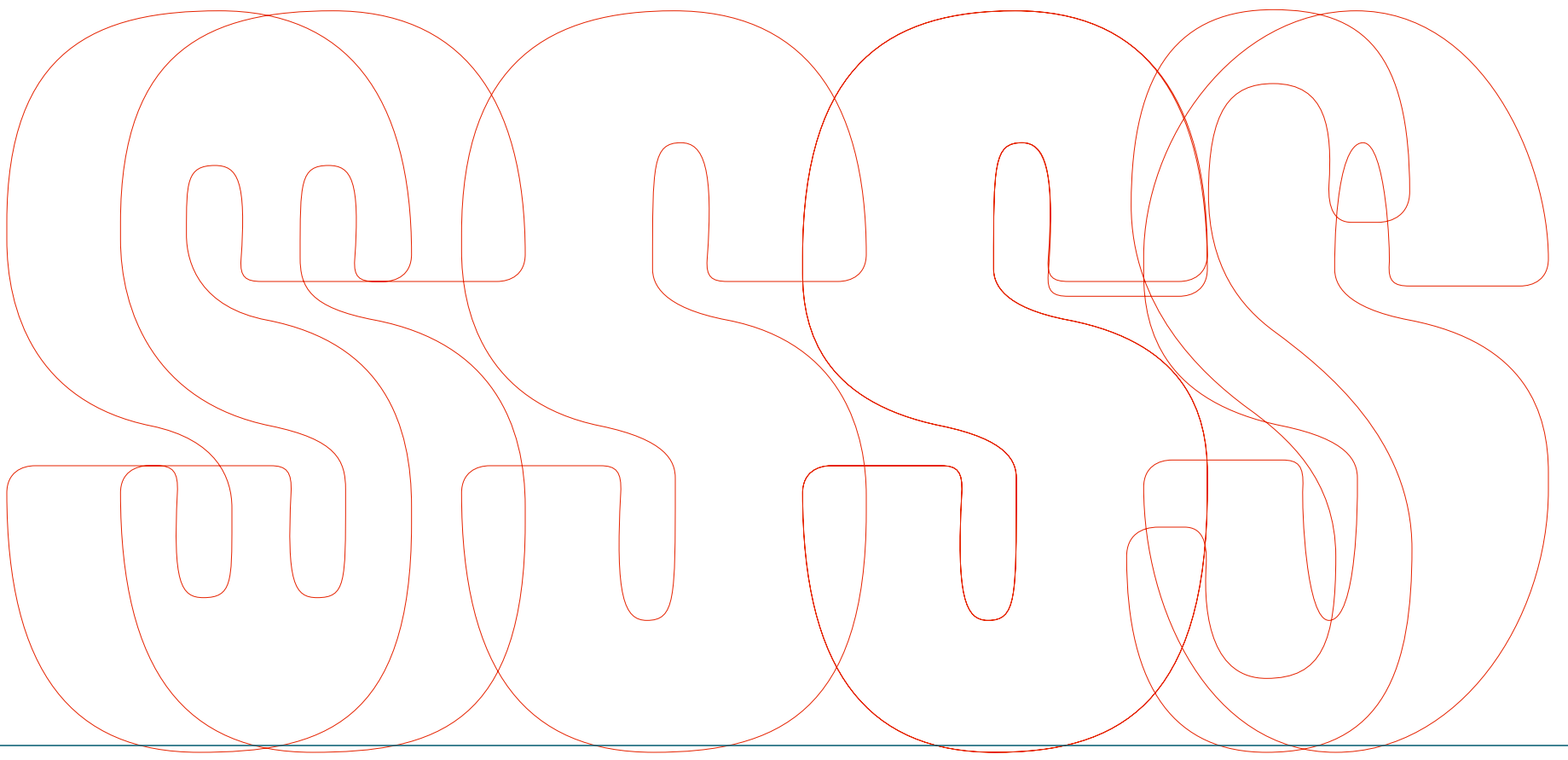
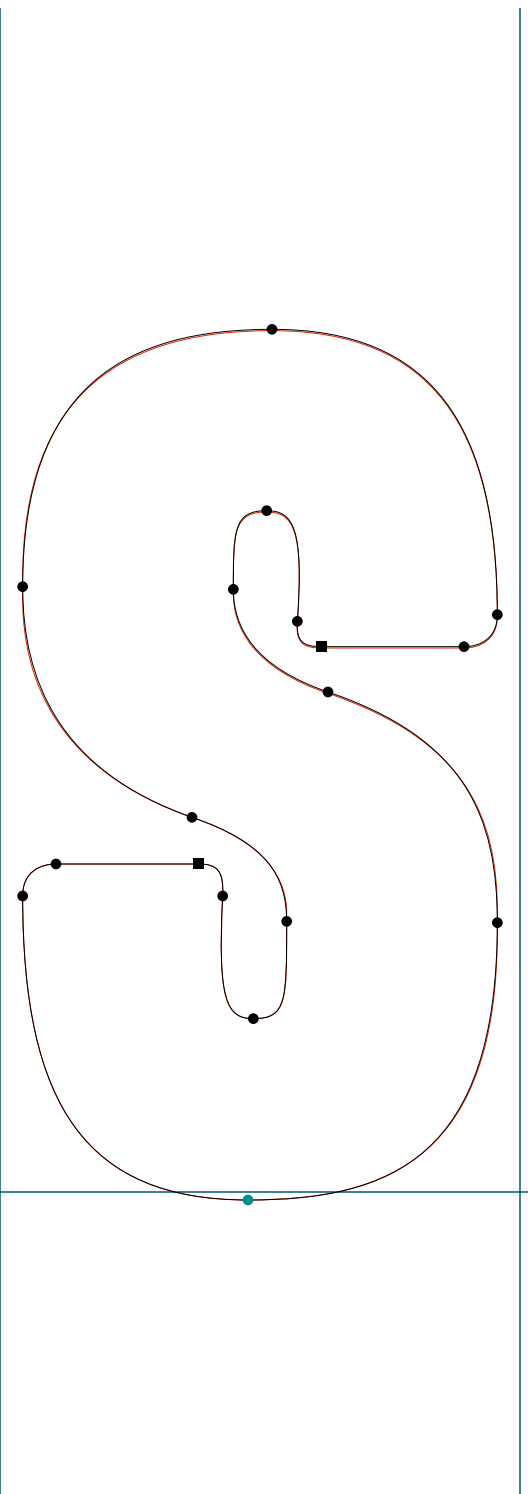

PROGRAM

.....
Program NarBlack | U | RoboFog Sketches | 2013 | Emigre Fonts

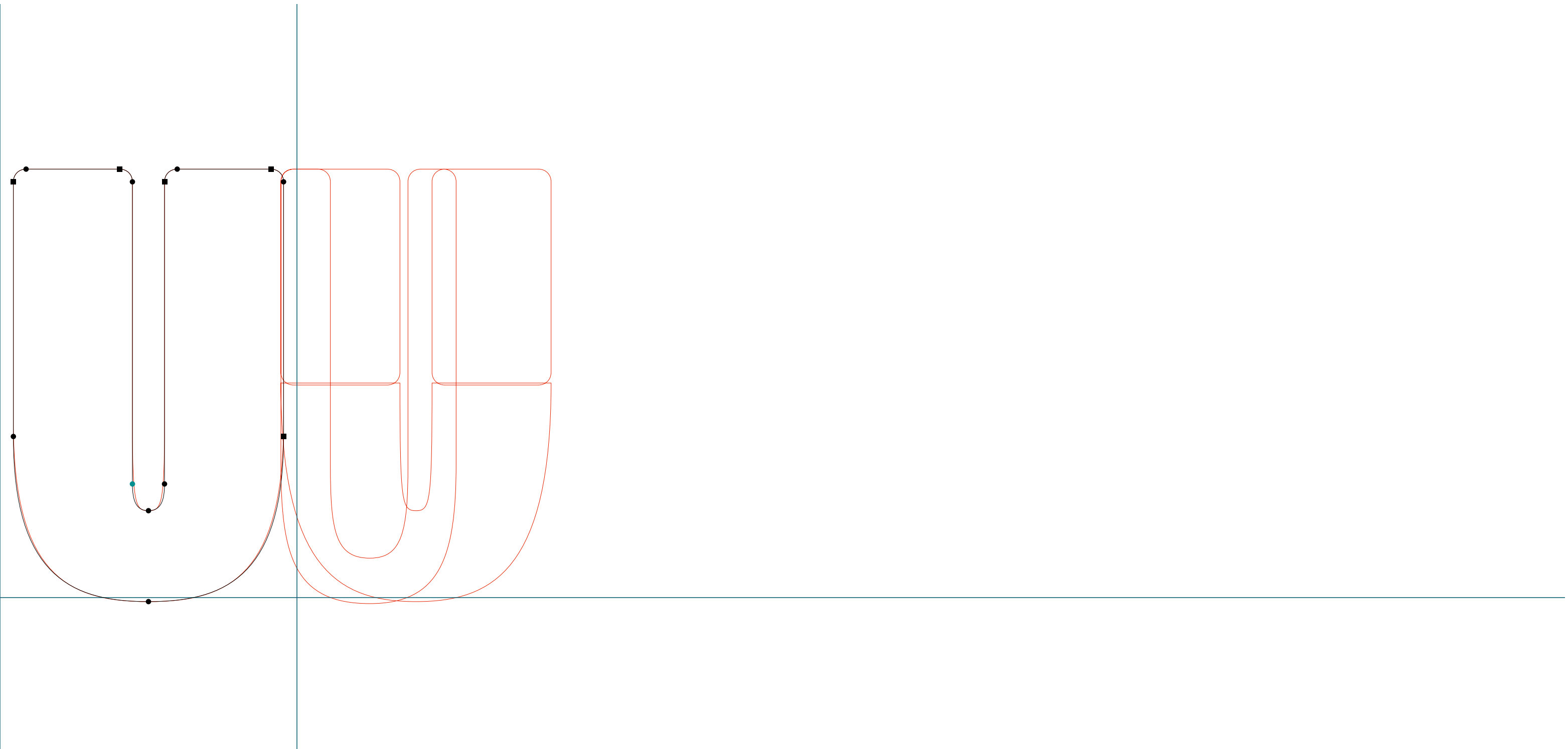

PROGRAM

.....
Program NarBlack | V | RoboFog Sketches | 2013 | Emigre Fonts

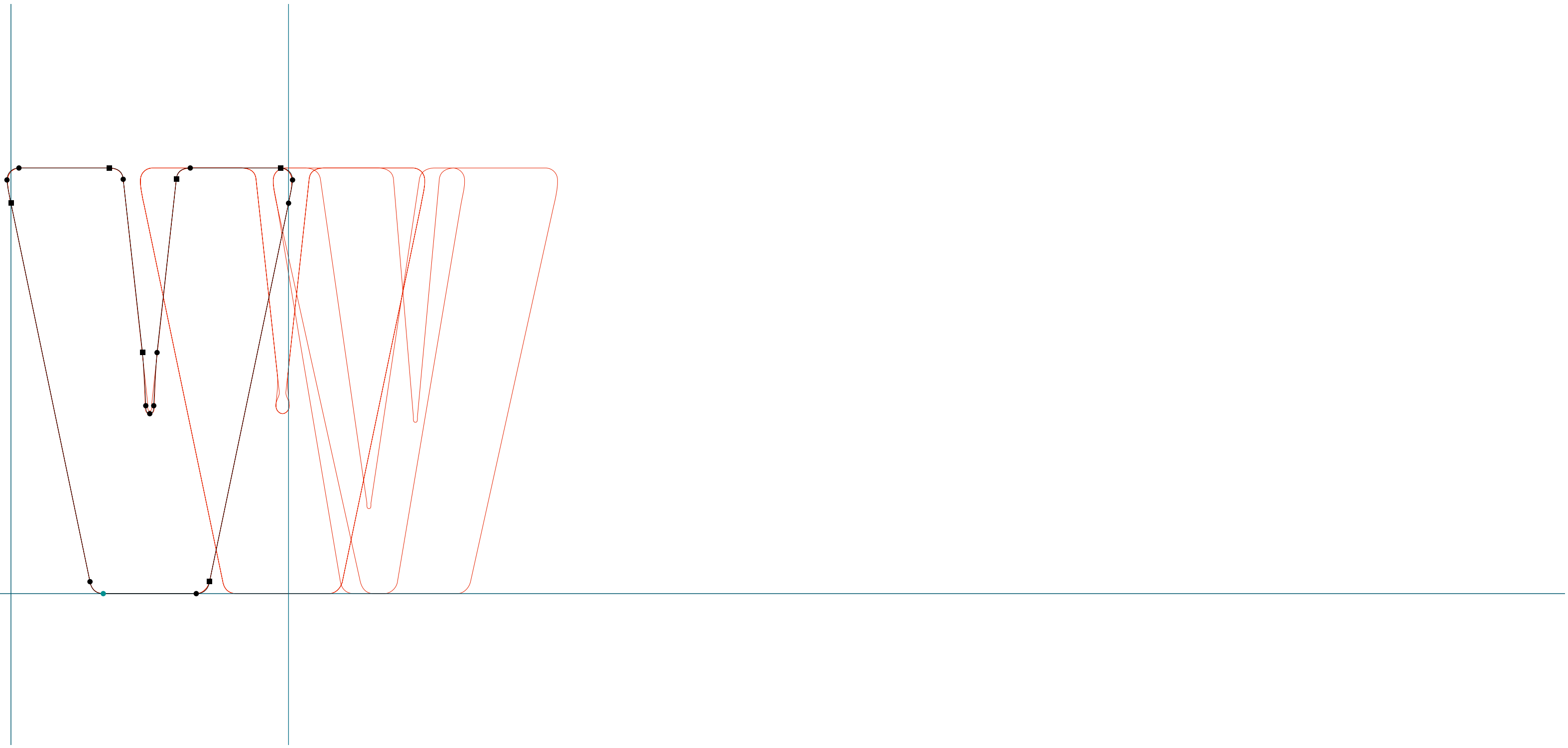

PROGRAM

.....
Program NarBlack | Y | RoboFog Sketches | 2013 | Emigre Fonts

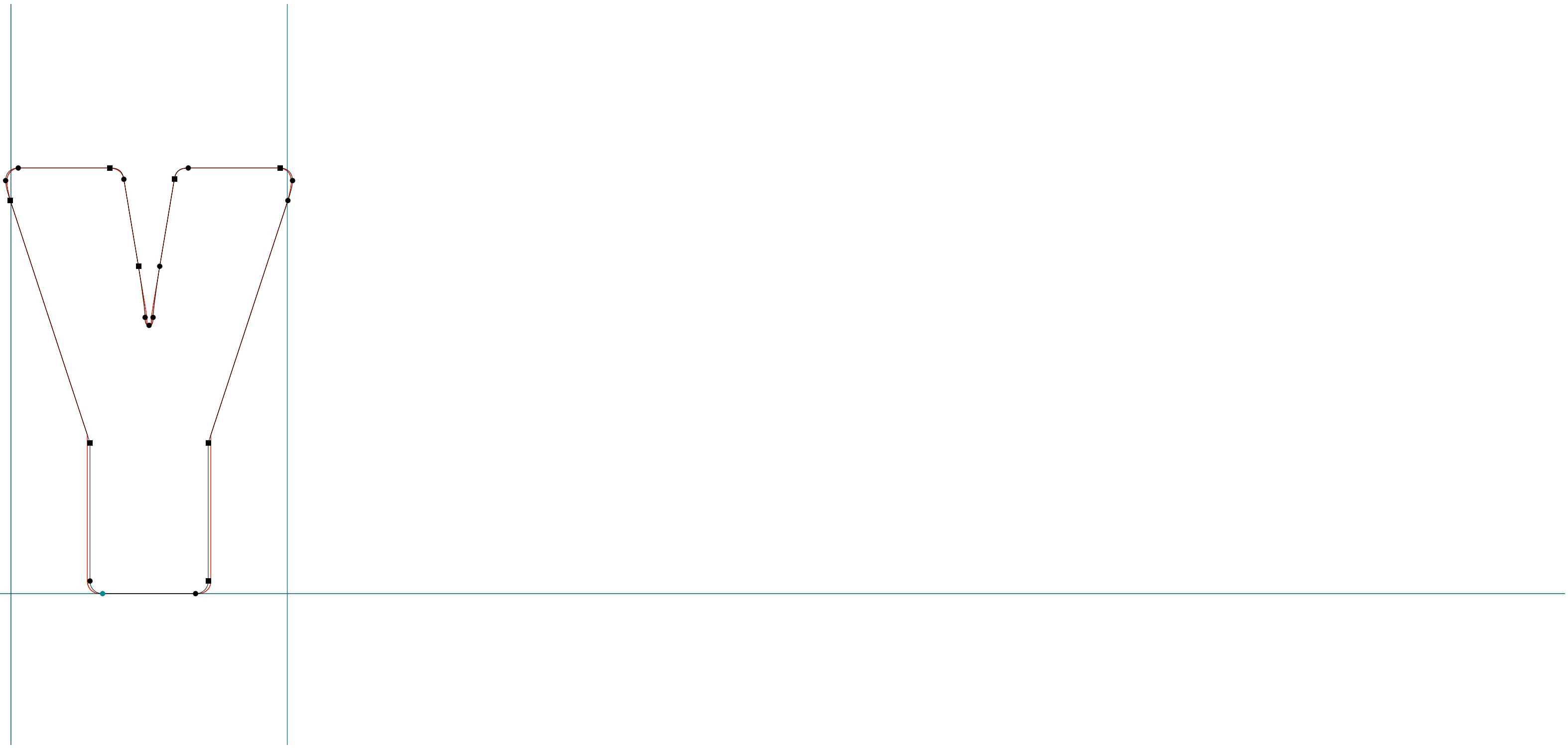

PROGRAM

.....
Program NarBlack | a | RoboFog Sketches | 2013 | Emigre Fonts

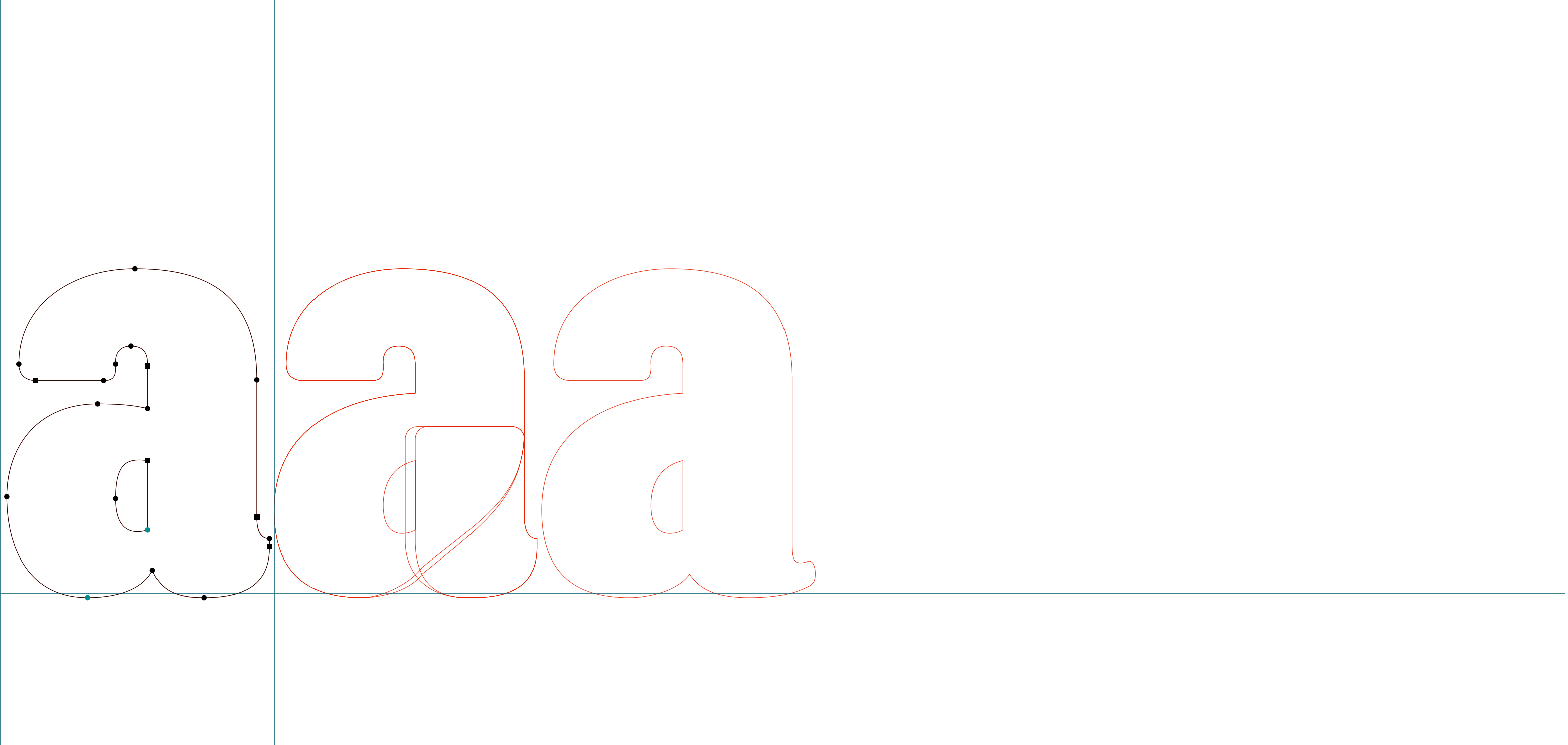

PROGRAM

.....
Program NarBlack | c | RoboFog Sketches | 2013 | Emigre Fonts

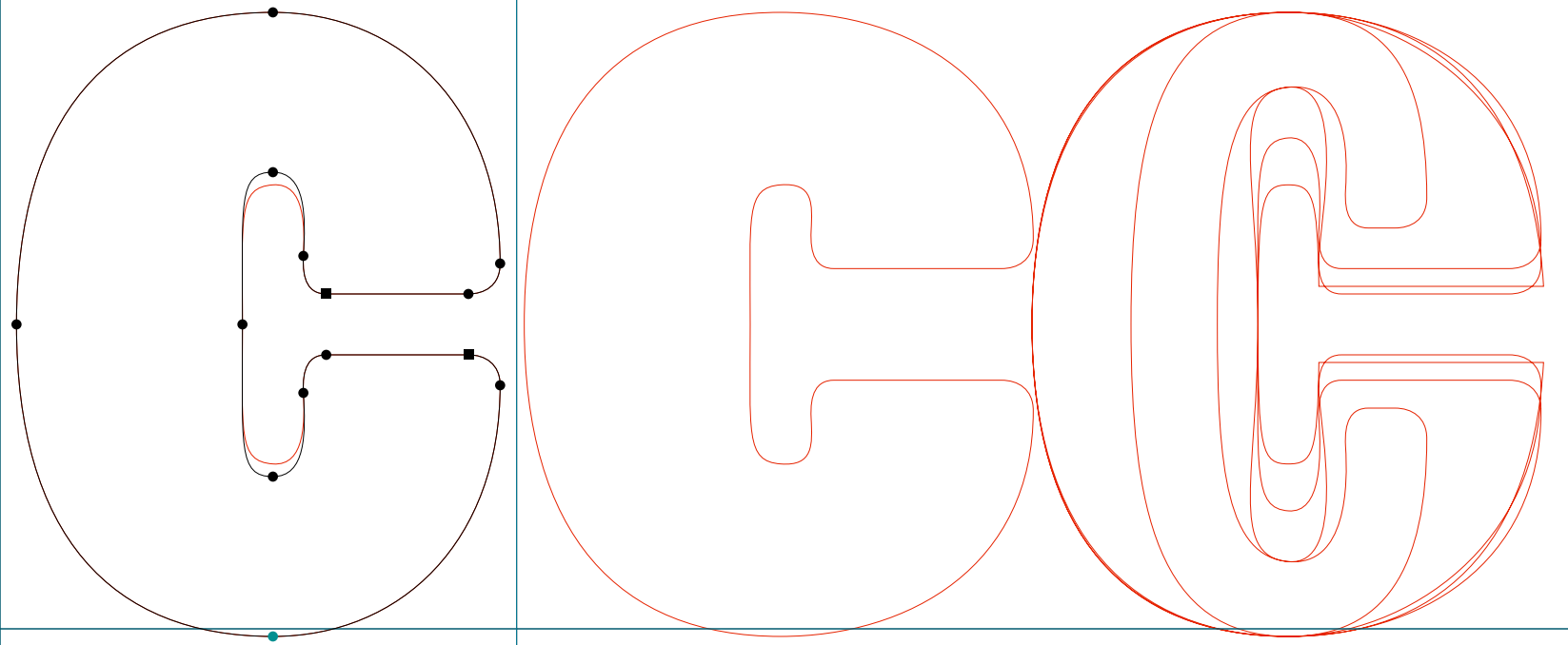

PROGRAM

.....
Program NarBlack | d | RoboFog Sketches | 2013 | Emigre Fonts

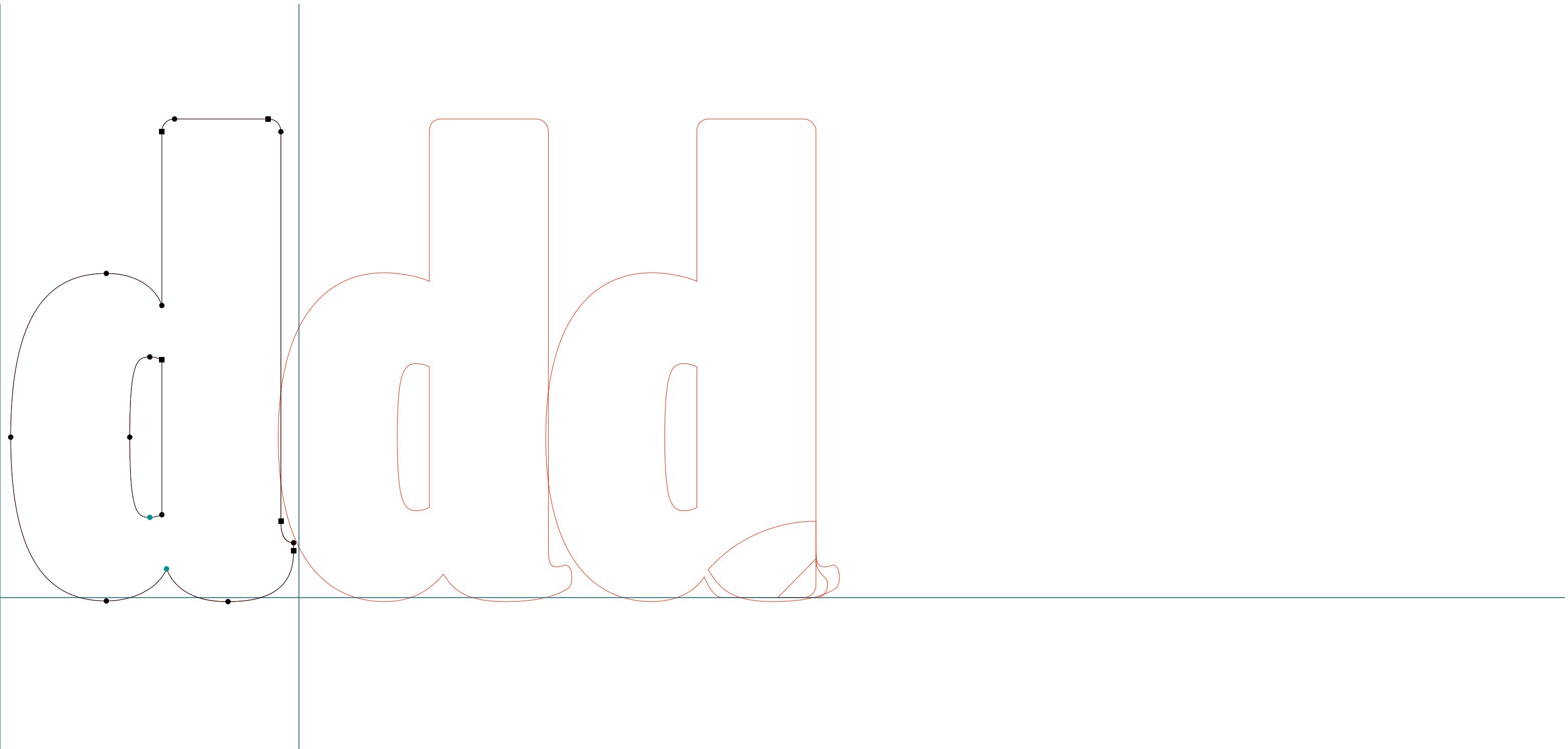

PROGRAM

.....
Program NarBlack | e | RoboFog Sketches | 2013 | Emigre Fonts

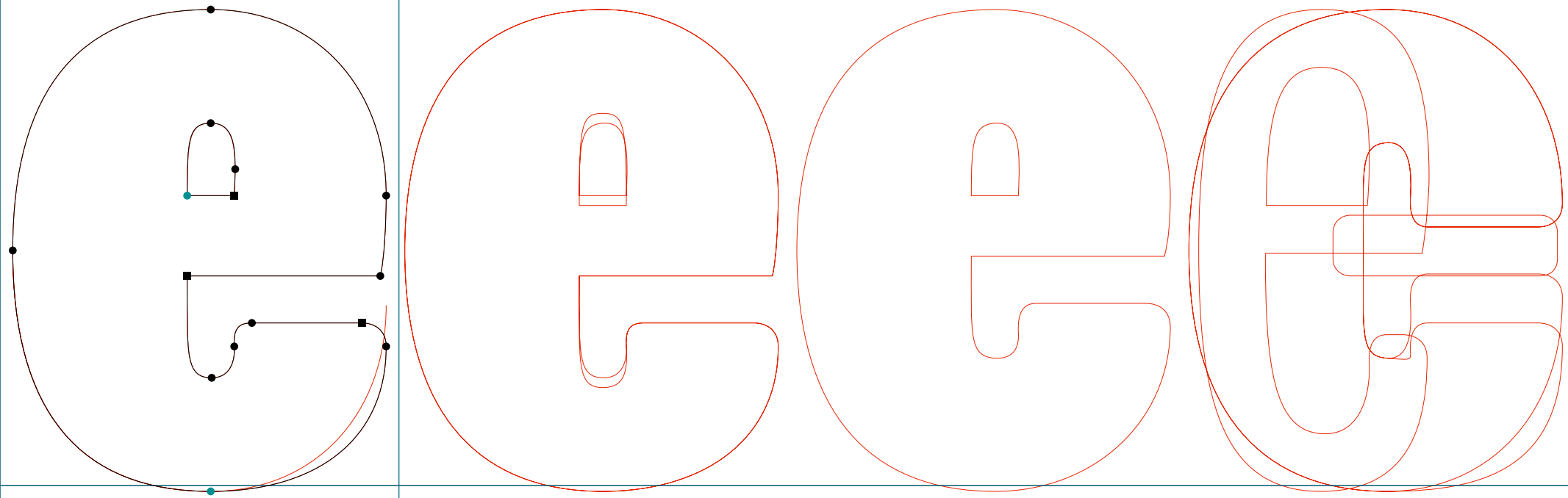

PROGRAM

.....
Program NarBlack | f | RoboFog Sketches | 2013 | Emigre Fonts

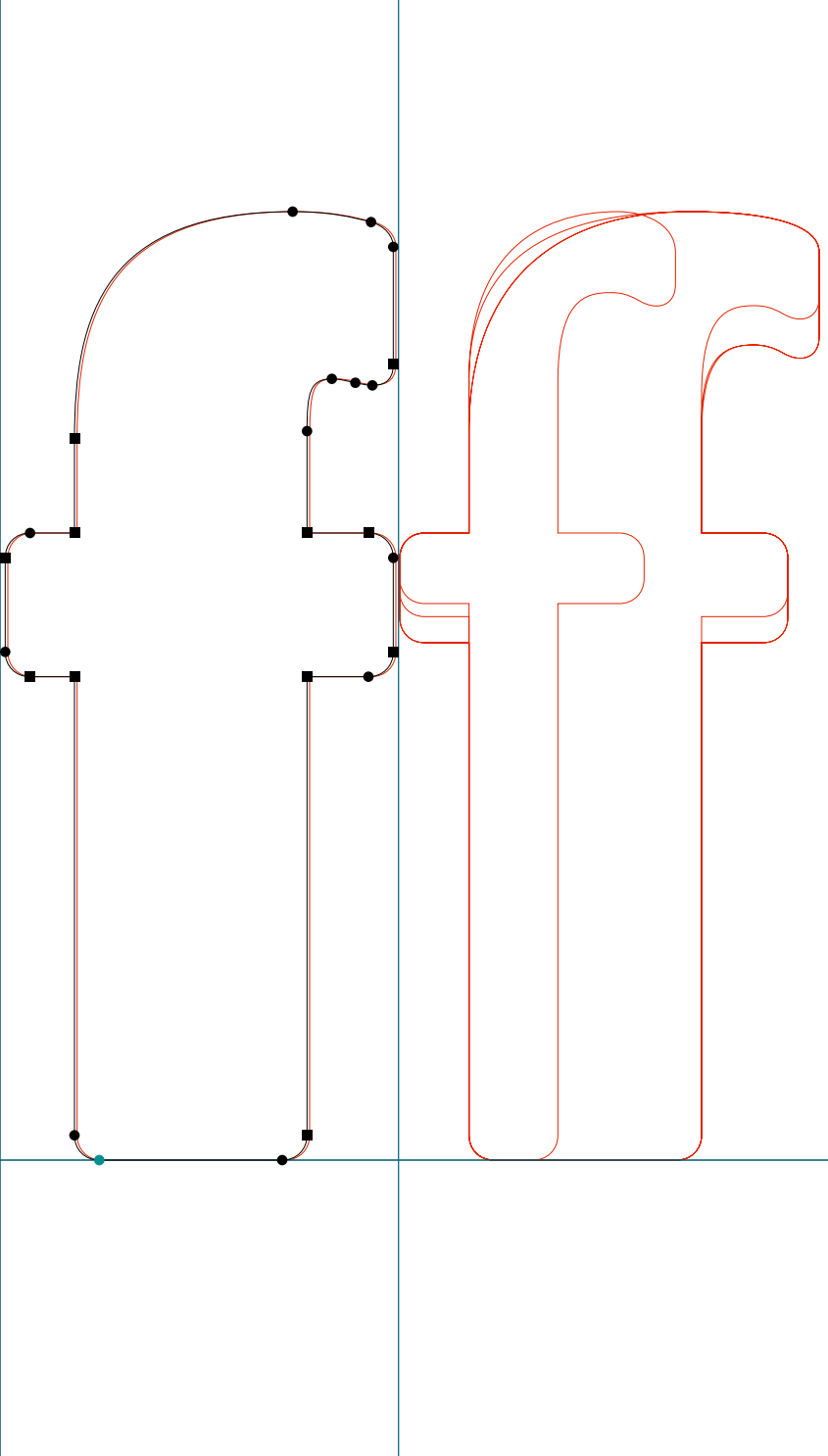

PROGRAM

.....
Program NarBlack | g | RoboFog Sketches | 2013 | Emigre Fonts

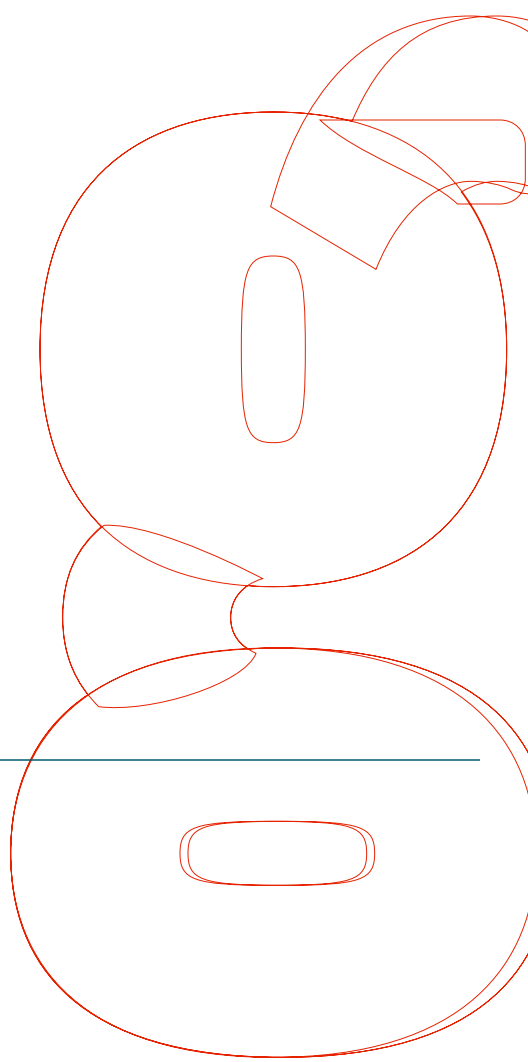
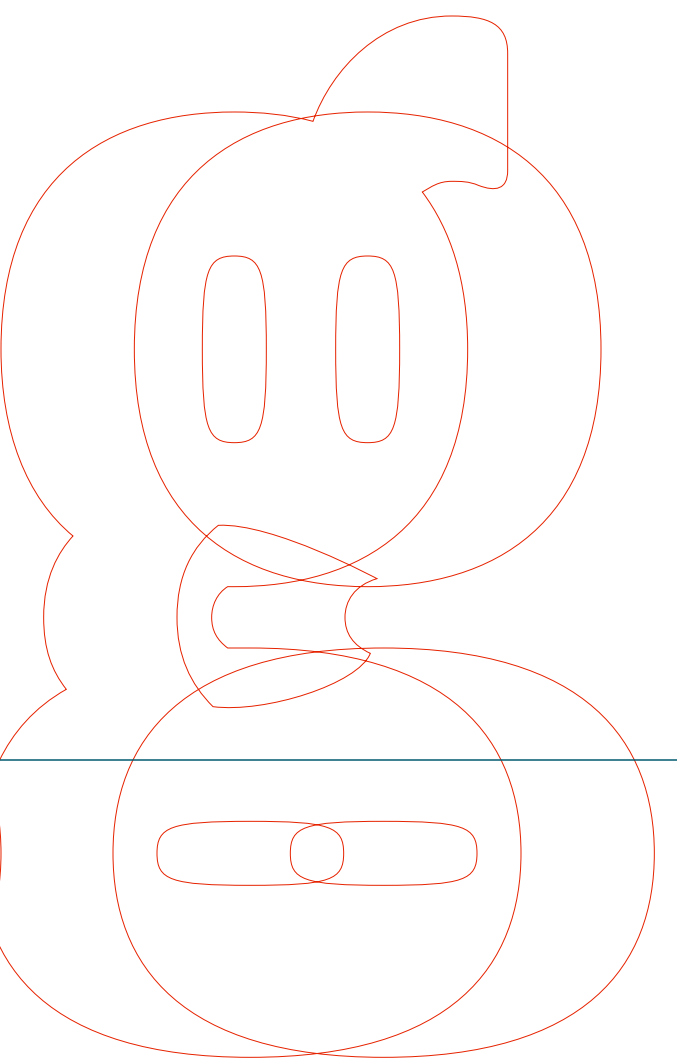
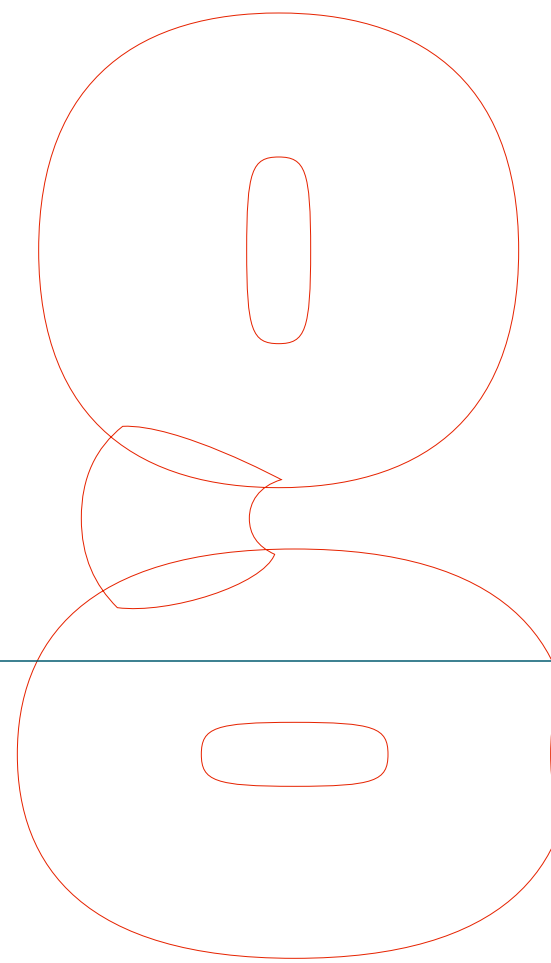
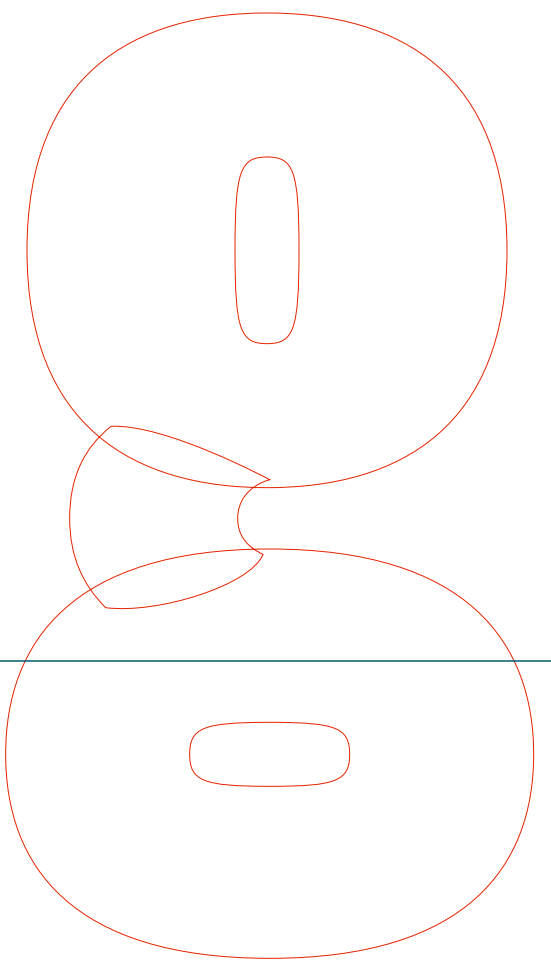
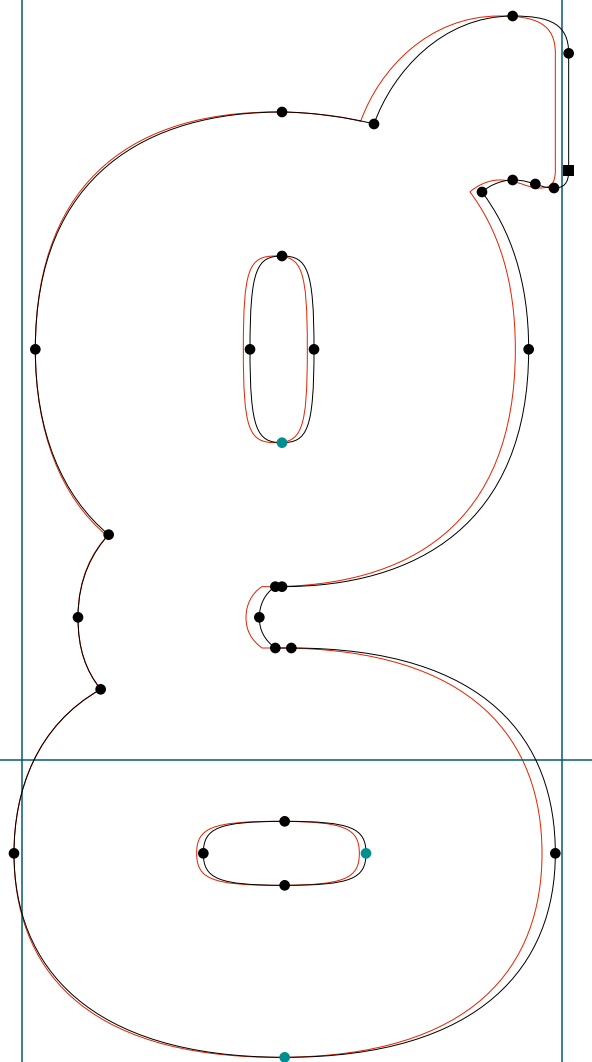
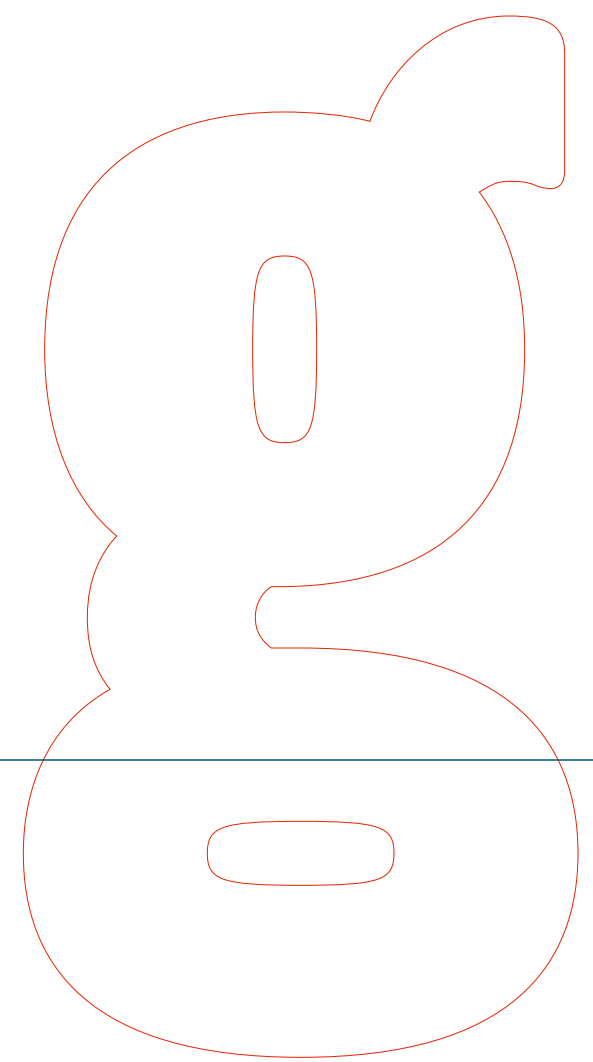

PROGRAM

.....
Program NarBlack | i | RoboFog Sketches | 2013 | Emigre Fonts

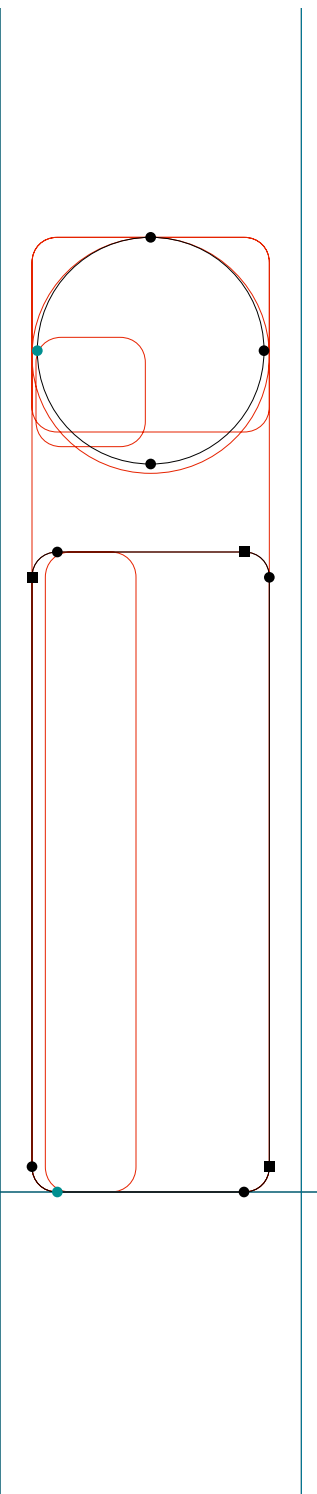

PROGRAM

.....
Program NarBlack | j | RoboFog Sketches | 2013 | Emigre Fonts

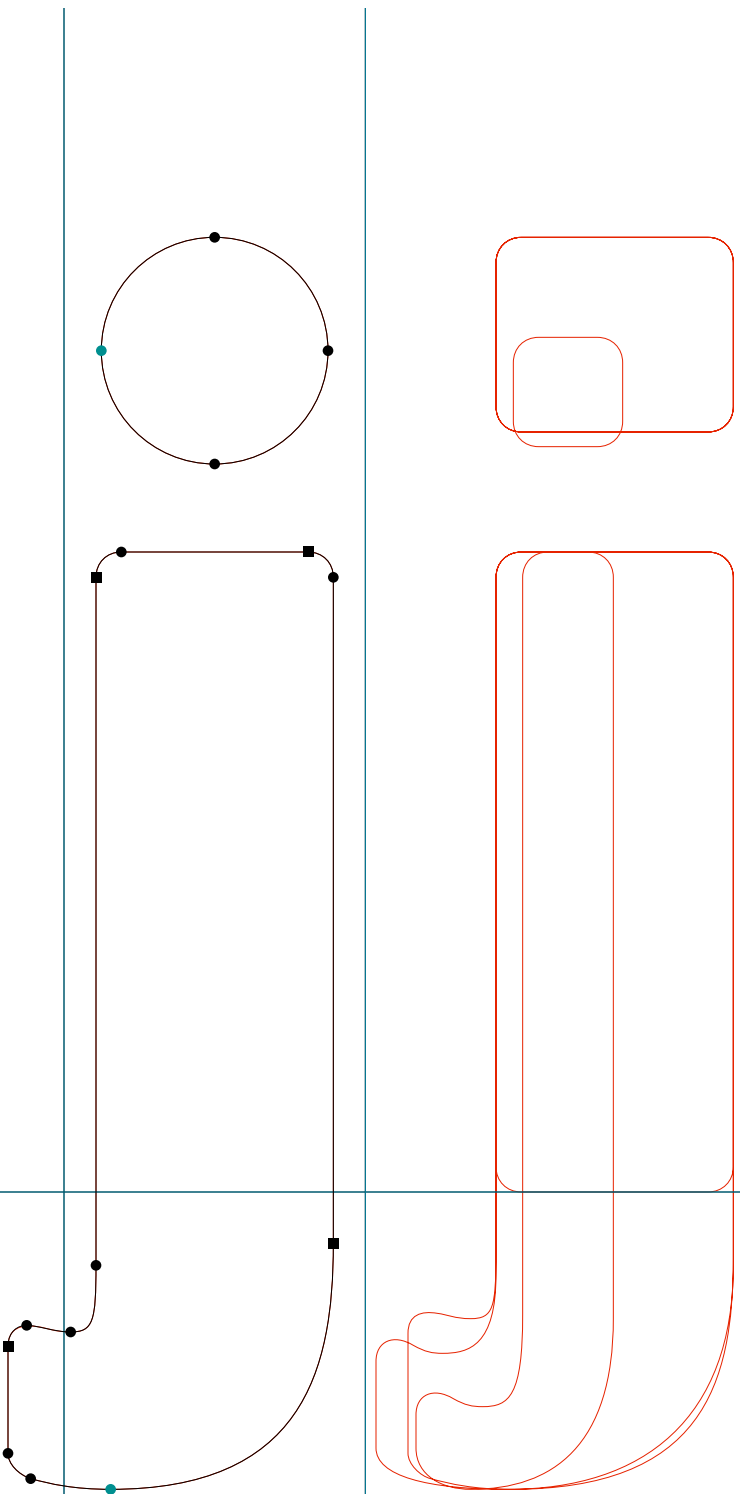

PROGRAM

.....
Program NarBlack | k | RoboFog Sketches | 2013 | Emigre Fonts

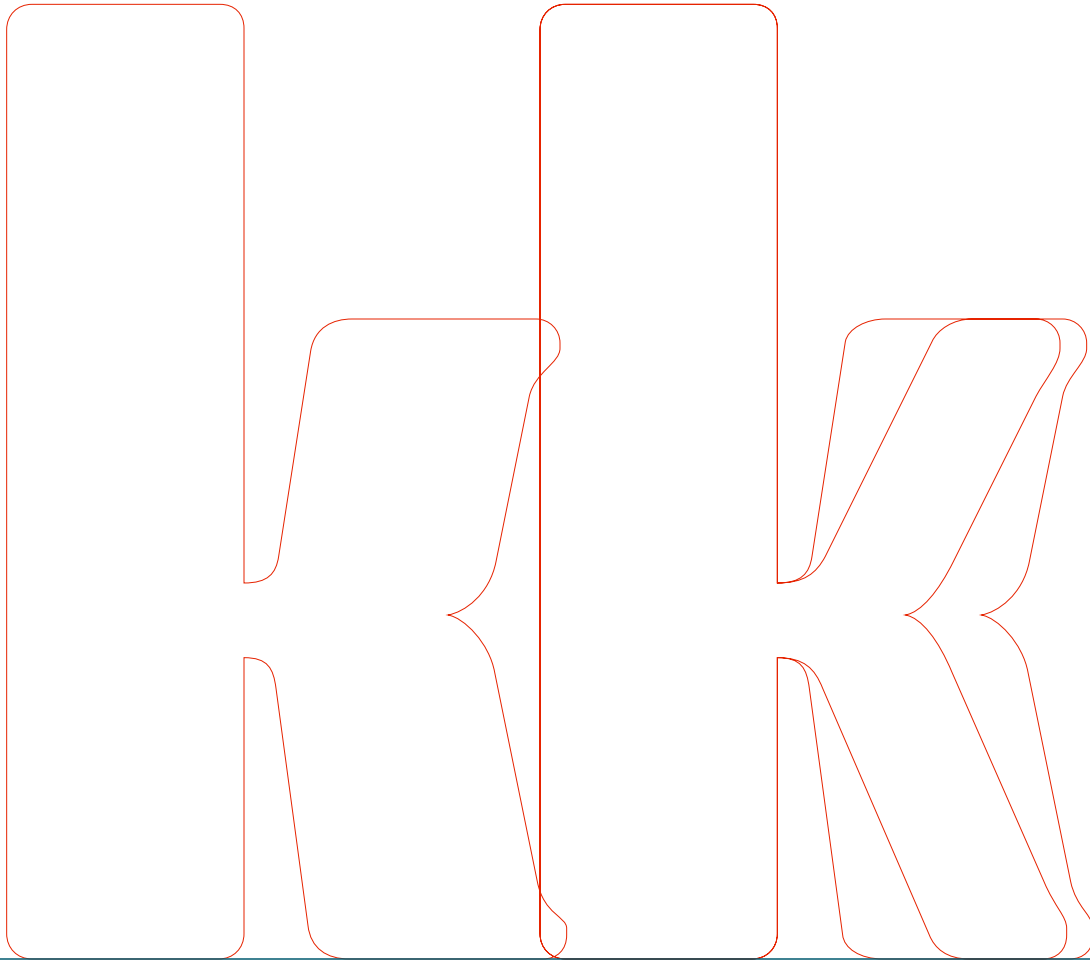
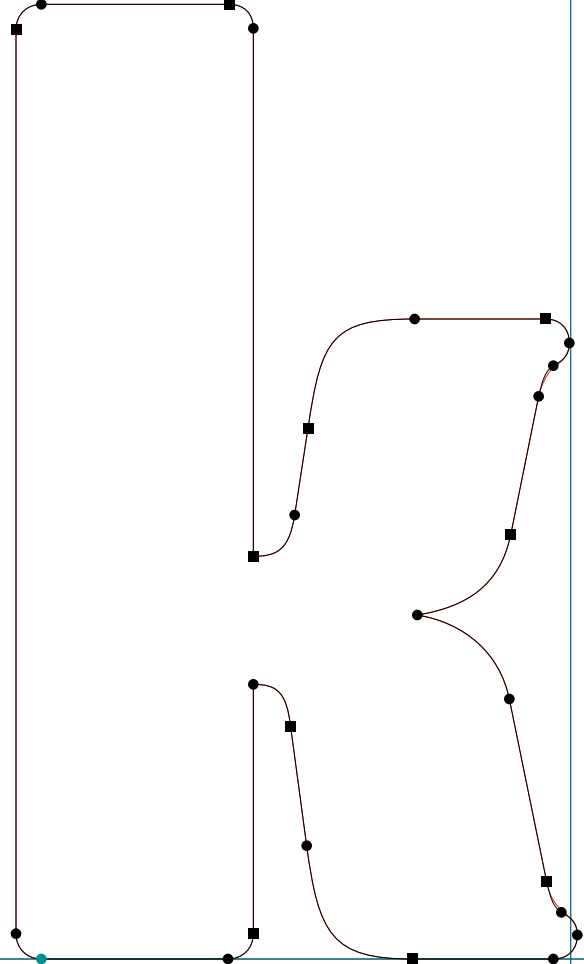
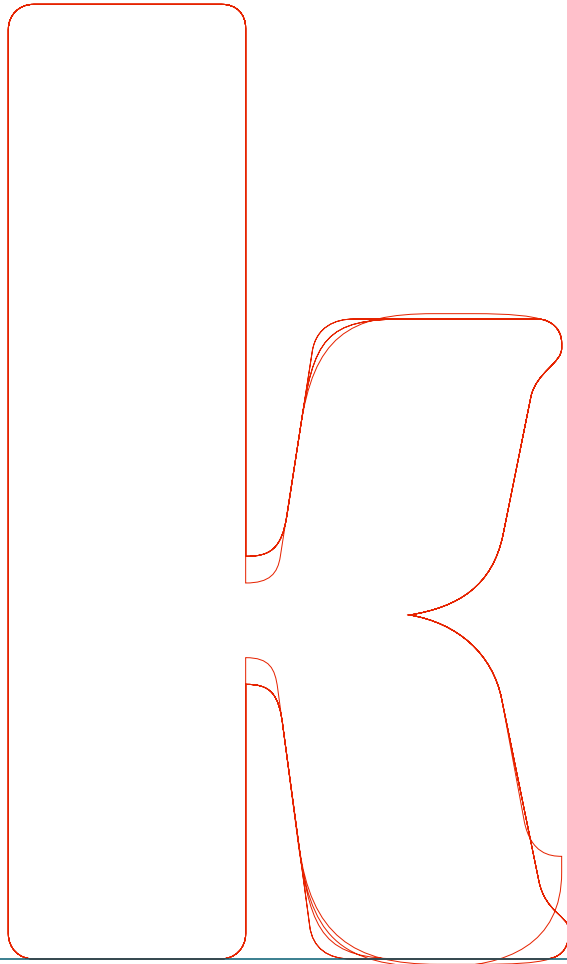

PROGRAM

.....
Program NarBlack | m | RoboFog Sketches | 2013 | Emigre Fonts

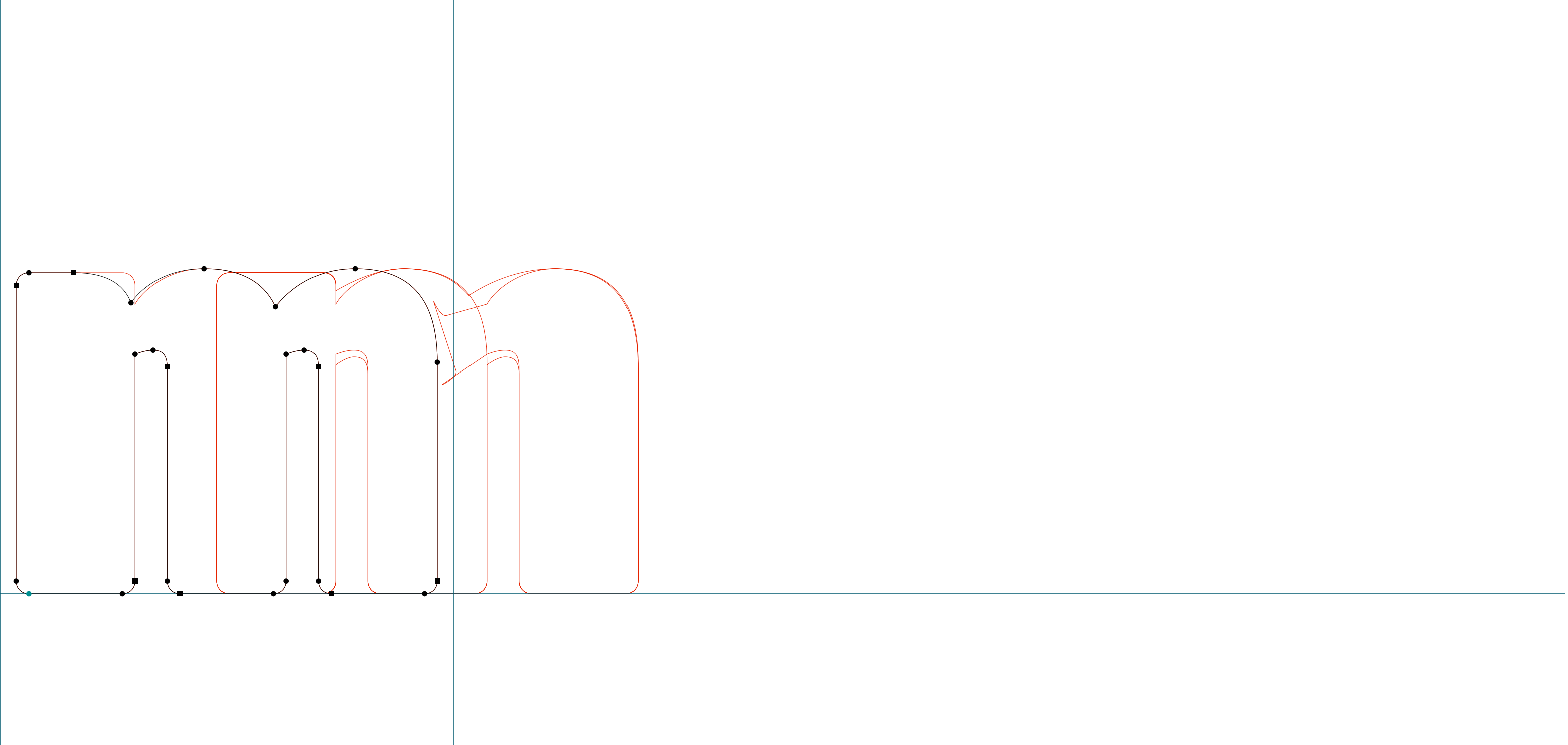

PROGRAM

.....
Program NarBlack | n | RoboFog Sketches | 2013 | Emigre Fonts

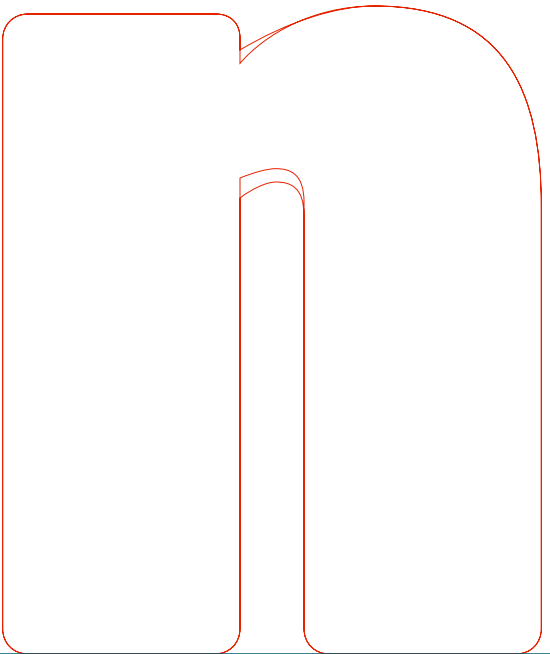
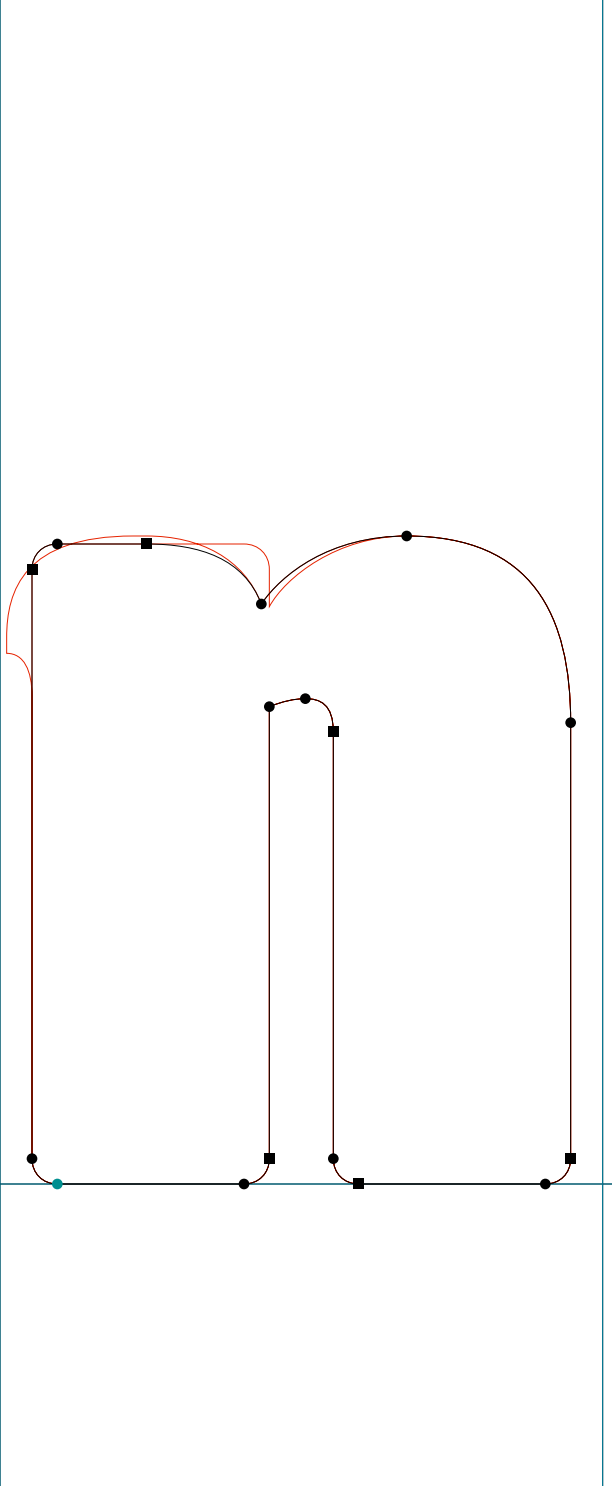

PROGRAM

.....
Program NarBlack | r | RoboFog Sketches | 2013 | Emigre Fonts

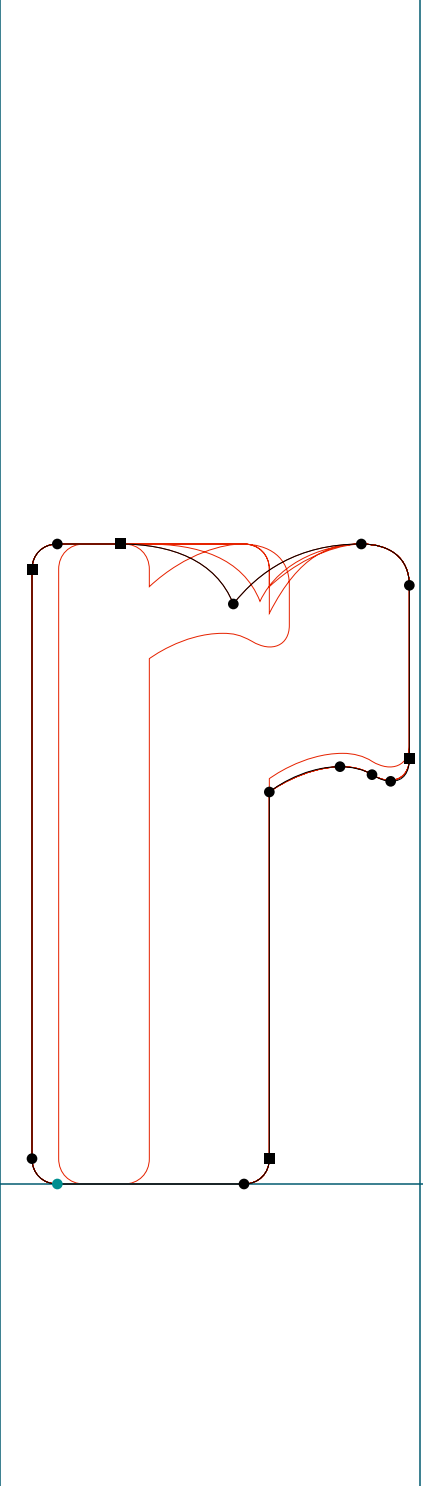

PROGRAM

.....
Program NarBlack | s | RoboFog Sketches | 2013 | Emigre Fonts

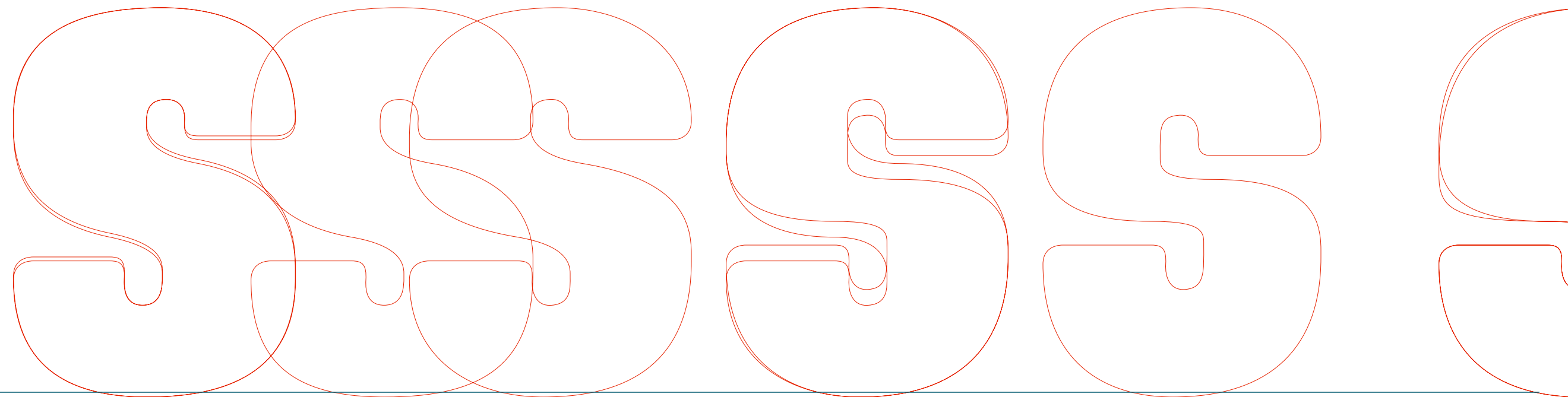
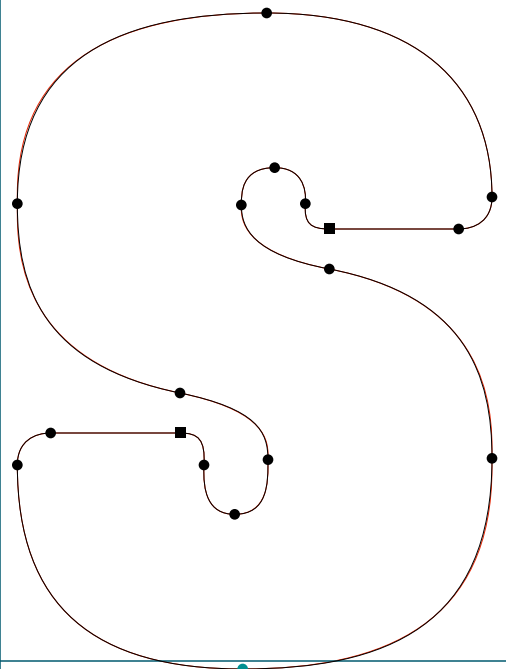

PROGRAM

.....
Program NarBlack | t | RoboFog Sketches | 2013 | Emigre Fonts

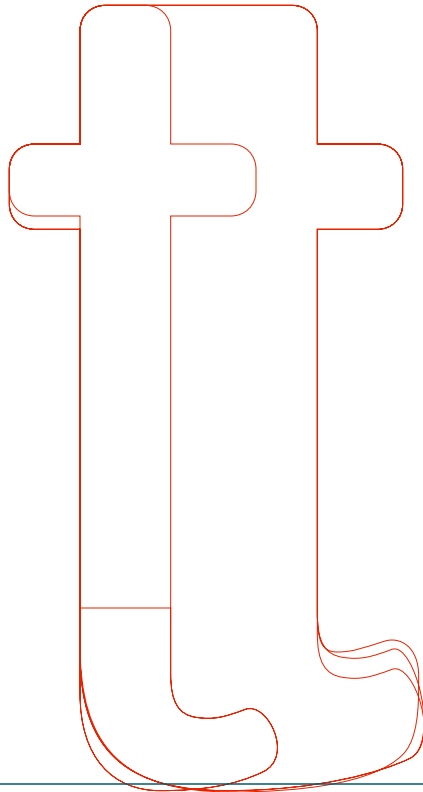
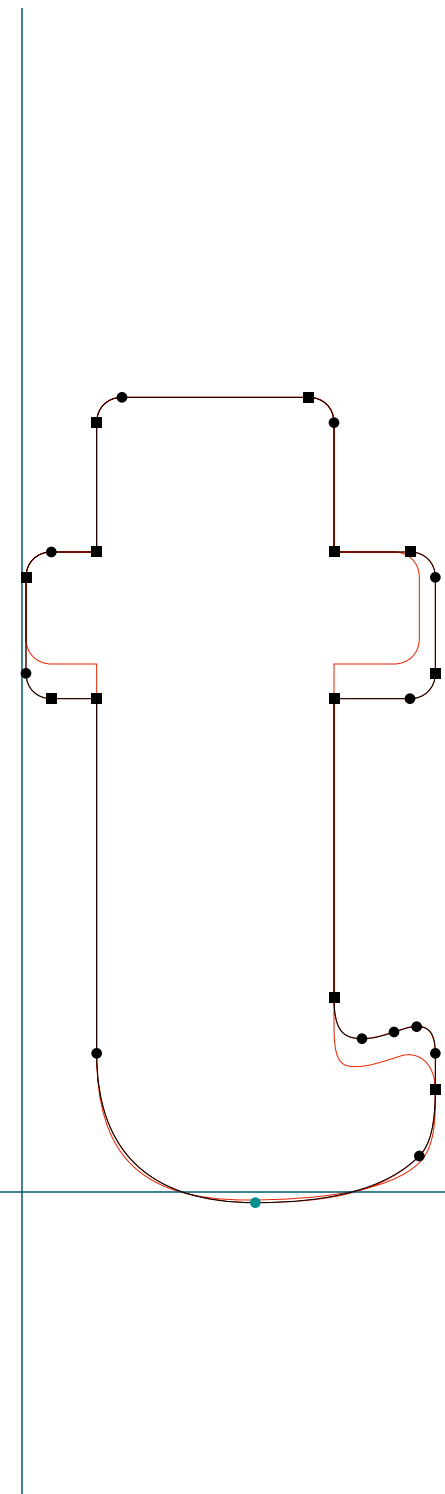

PROGRAM

.....
Program NarBlack | u | RoboFog Sketches | 2013 | Emigre Fonts

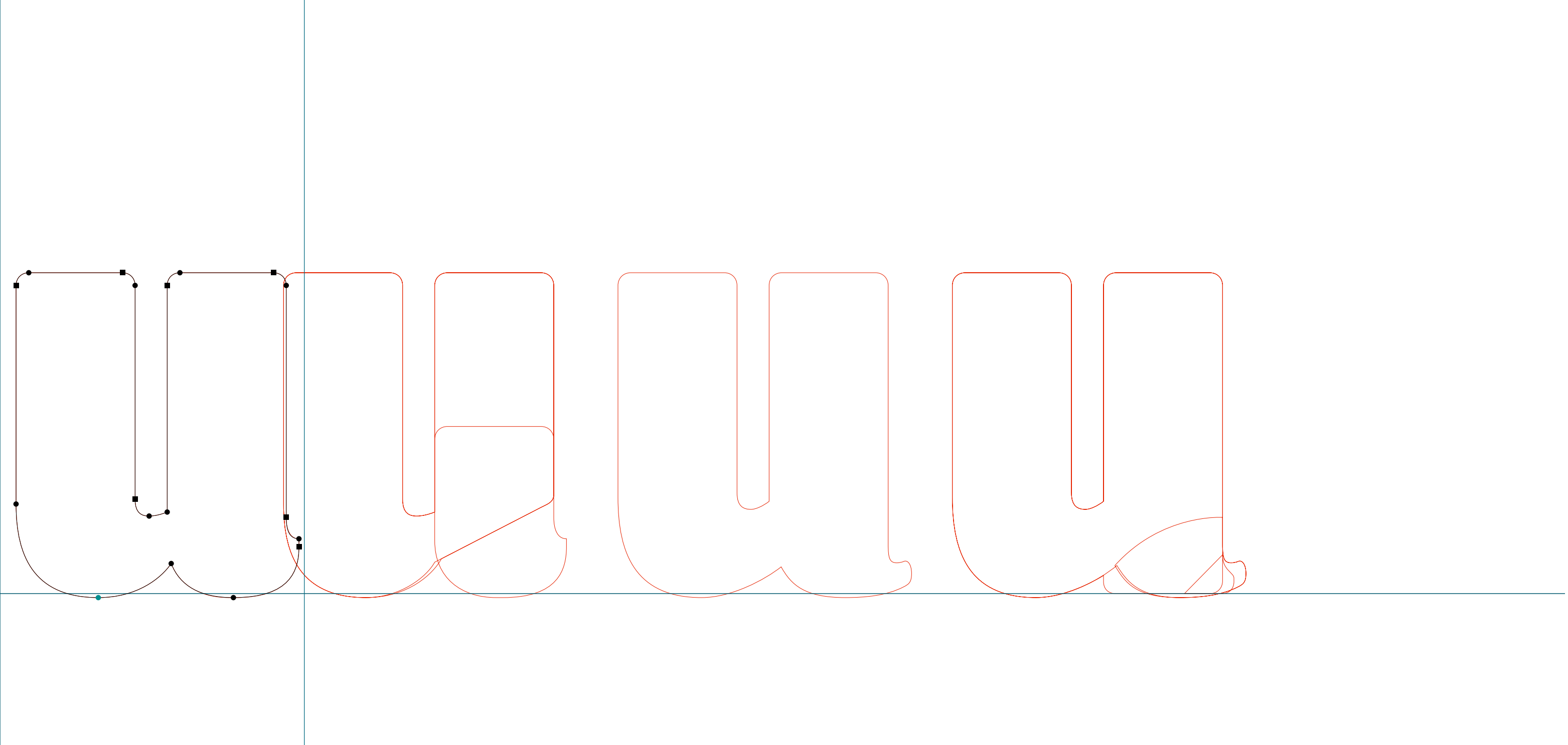

PROGRAM

.....
Program NarBlack | v | RoboFog Sketches | 2013 | Emigre Fonts



PROGRAM

.....
Program NarBlack | x | RoboFog Sketches | 2013 | Emigre Fonts

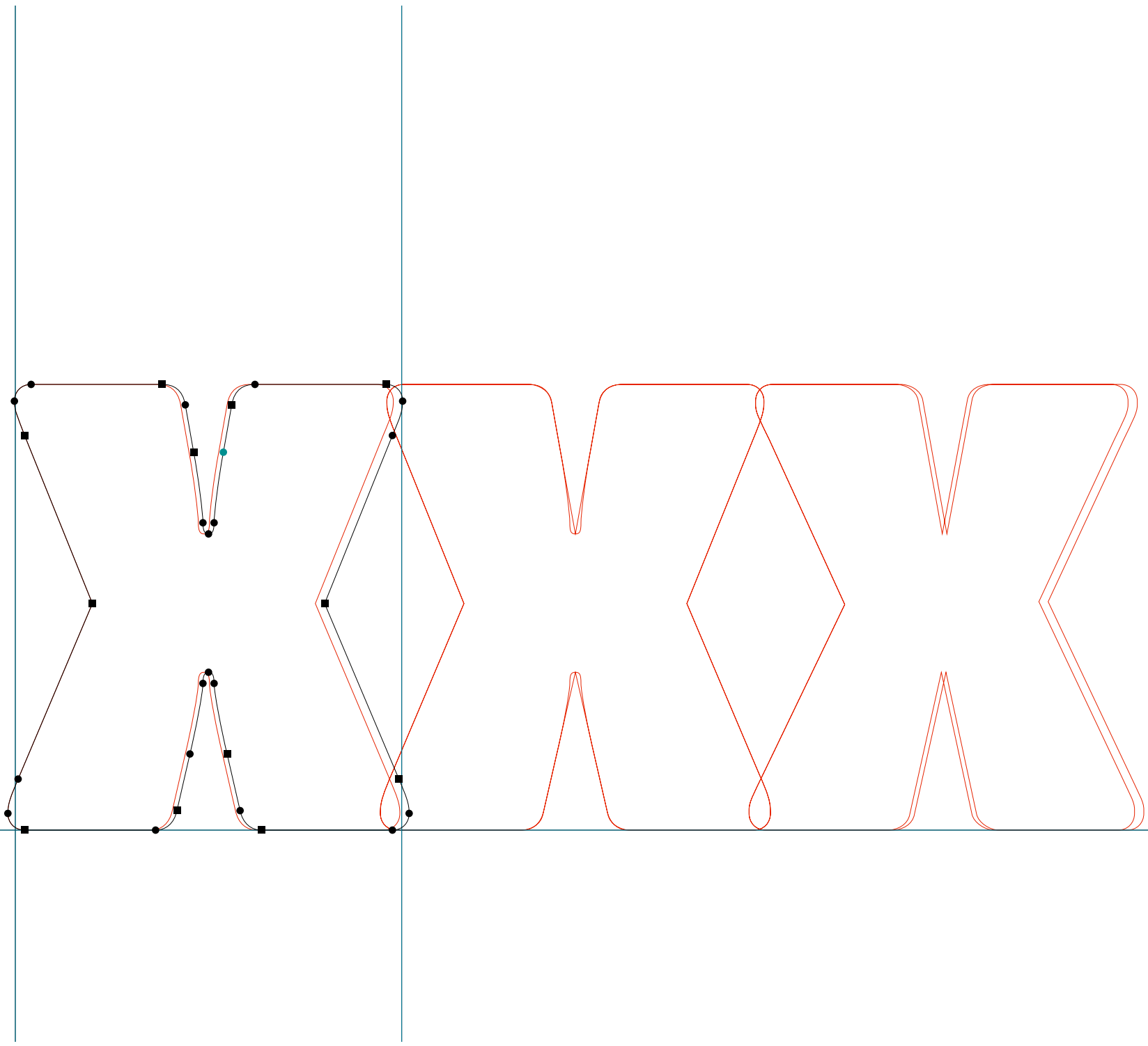

PROGRAM

.....
Program NarBlack | y | RoboFog Sketches | 2013 | Emigre Fonts

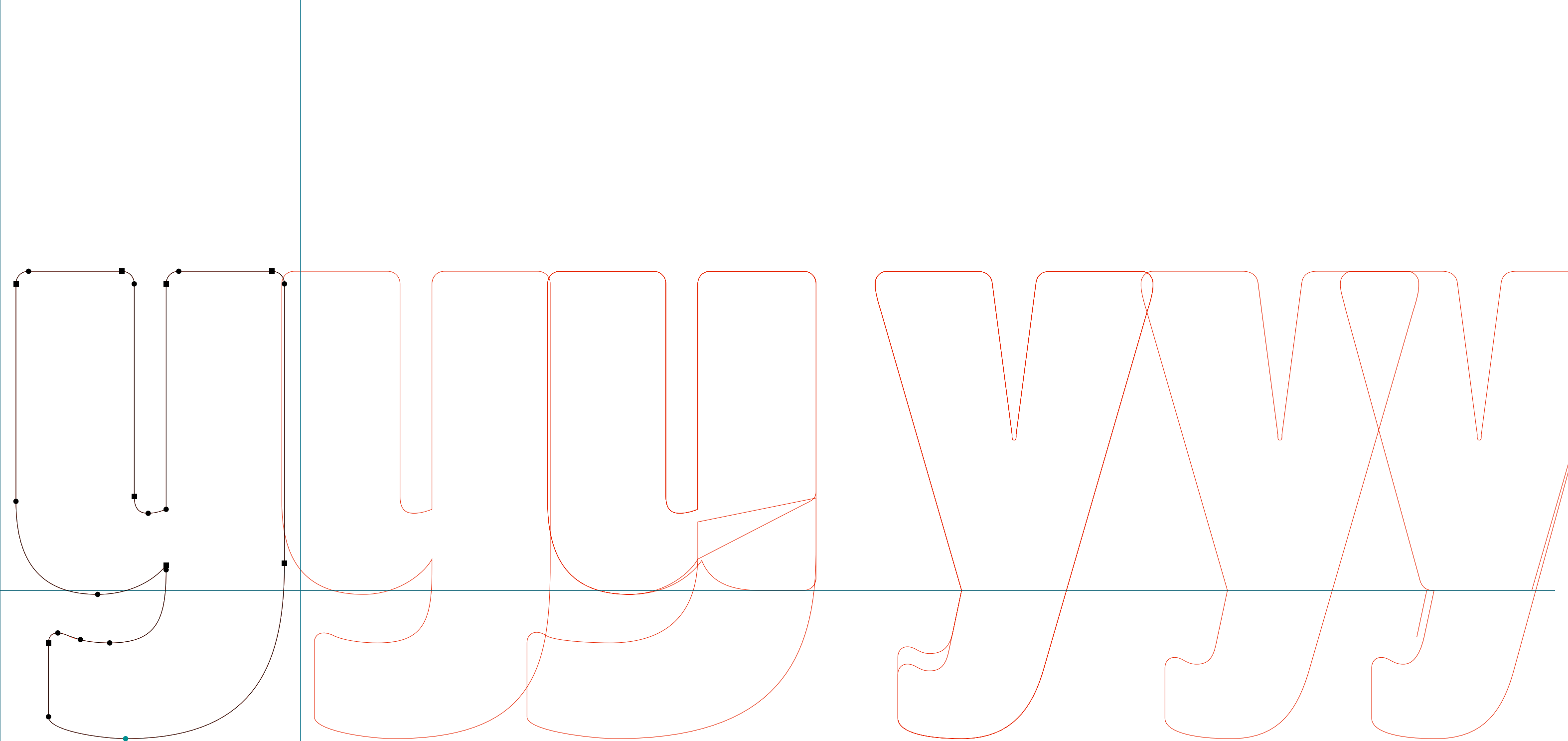

PROGRAM

.....
Program NarBlack | section | RoboFog Sketches | 2013 | Emigre Fonts

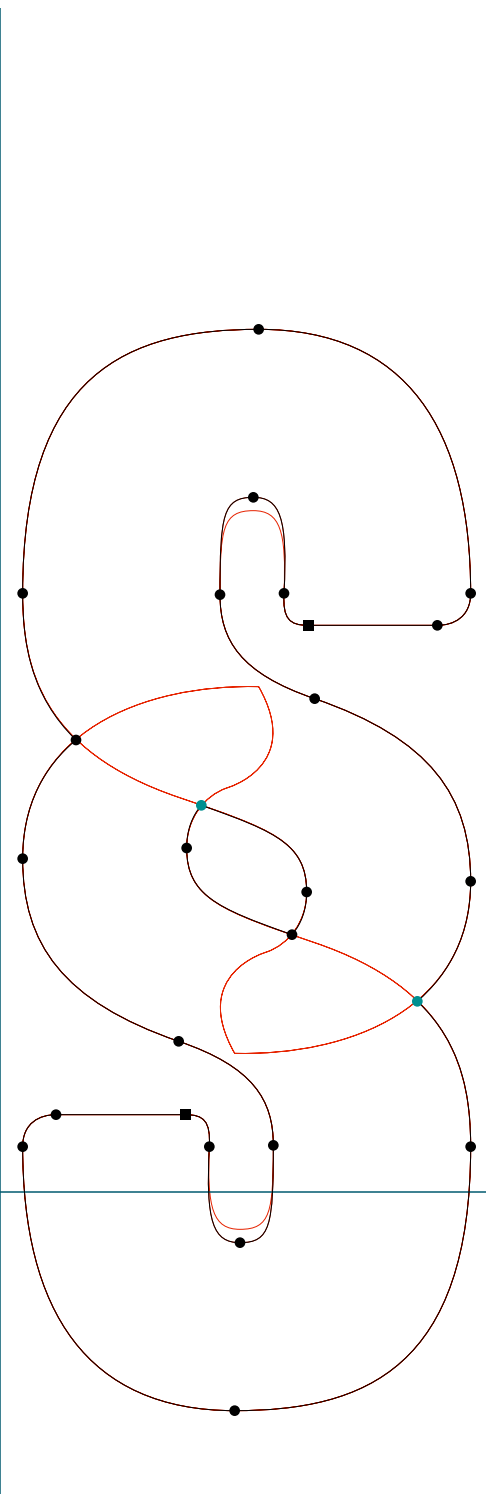

PROGRAM

Program NarBlack | germandbls | RoboFog Sketches | 2013 | Emigre Fonts

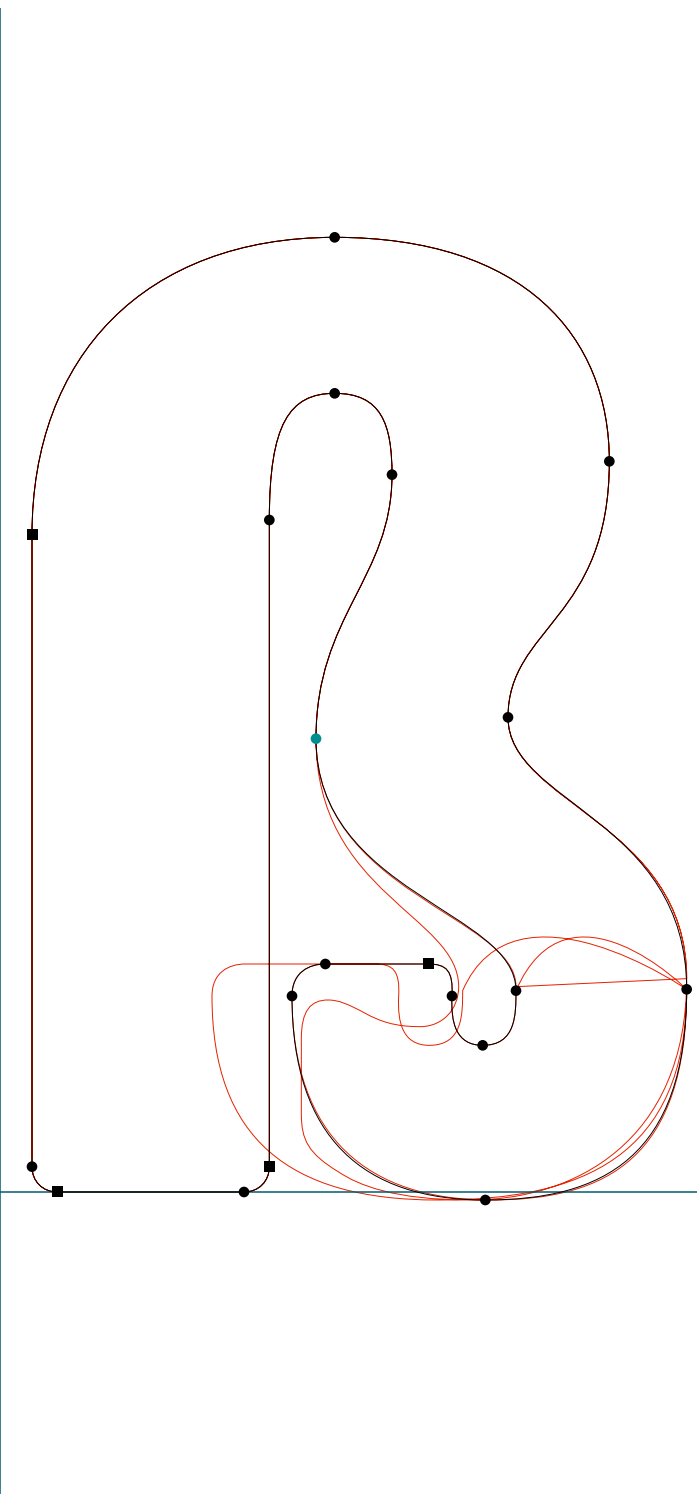

PROGRAM

.....
Program NarBlack | apple | RoboFog Sketches | 2013 | Emigre Fonts

